

Niederspannungsschaltgeräte

Lasttrennschalter



SÄLZER

Innovation. Technologie. Qualität.

Schaltgeräte von Sälzer: Lösungen für die Zukunft! Seit 1956 hat sich Sälzer auf Entwicklung, Fertigung und Vertrieb von Niederspannungsschaltgeräten spezialisiert.

Durch eine große Auswahl an Typen, Schaltprogrammen und Bauformen können praxissichere Lösungen schnell realisiert werden. Um welchen Schalter es sich auch handelt, alle Einzelteile sind optimal aufeinander abgestimmt, einfach zu montieren und zu kombinieren.

Ob in Schalt- und Automatisierungsanlagen, im Maschinen- und Fahrzeugbau, in der Heizungs-, Klima- und Lüftungstechnik, in der Umwelttechnik oder anderen Gebieten:
Sälzer sorgt für Sicherheit!

Beratung, Schulung und Service sowie ein zertifiziertes Qualitätsmanagementsystem nach DIN EN ISO 9001 sind Bestandteil unserer täglichen Arbeit. Unsere Schalter erfüllen die nationalen und internationalen Normen (IEC / cUL) und sind weltweit einsetzbar.

Sonderwünsche?

Wir beraten Sie gerne und entwickeln für Sie eine individuelle Lösung nach Maß. Unsere Projektingenieure denken sich hinein in das Besondere Ihrer Aufgabenstellung und stehen Ihnen als Entwicklungspartner hilfreich zur Seite.

Und sollten Ihre Anforderungen einmal so speziell sein, dass selbst unser breites Lieferprogramm diese nicht abdeckt, verfügen wir im eigenen Haus über eine Sonderschalterfertigung, mit der wir auch individuellste Aufträge flexibel und zeitnah erfüllen werden.

Lasttrennschalter

ab S.8

Sicheres Schalten und Trennen

SMD – Sälzer Modular Design



Schneller liefern durch SMD!

Das SMD-System (Sälzer Modular Design) basiert auf einem modularen Produktprinzip, so dass eine sehr hohe Flexibilität in den Produktausführungen gewährleistet wird.

SMD-Module sind einzeln vorgefertigte und geprüfte Komplettmodule. Durch Kombination dieser Grundelemente können so unterschiedlichste Schalterkonfigurationen schnell realisiert werden. Aus Grundschaltermodul, Bauformmodul und Antriebsmodul kann der vom Kunden gewünschte Schalter im SMD-Service mit wenigen Handgriffen zur Lieferung bereitgestellt werden.

Innerhalb von 24h ist die auf Ihre Anforderungen zugeschnittene Lösung auf dem Weg zu Ihnen – und das weltweit!

Inhaltsverzeichnis

	Seite
Info: Neu in diesem Katalog	6
Lasttrennschalter	8
Produktübersicht , Einbauvarianten	10
Aufbau der Bestellnummer	11
Haupt-/Notausschalter	12
Fronteinbau Vierlochbefestigung	12
Fronteinbau Zentralbefestigung	17
Bodeneinbau Schnappbefestigung für Installationsverteiler	19
Bodeneinbau Schnappbefestigung mit Türverriegelung	21
Bodeneinbau Vierlochbefestigung mit Türverriegelung	29
Gekapselte Schalter mit Isolierstoffgehäuse	31
Gekapselte Schalter mit Isolierstoffgehäuse für EMV-Anwendung	37
Gekapselte Schalter mit Stahlgehäuse	38
Gekapselte Schalter mit Edelstahlgehäuse	44
Hauptschalter	46
Fronteinbau Vierlochbefestigung	46
Fronteinbau Zentralbefestigung	51
Bodeneinbau Schnappbefestigung für Installationsverteiler	53
Bodeneinbau Schnappbefestigung mit Türverriegelung	55
Bodeneinbau Vierlochbefestigung mit Türverriegelung	63
Gekapselte Schalter mit Isolierstoffgehäuse	65
Gekapselte Schalter mit Isolierstoffgehäuse für EMV-Anwendung	71
Gekapselte Schalter mit Stahlgehäuse	72
Gekapselte Schalter mit Edelstahlgehäuse	78

	Seite
Ein-/Ausschalter	80
Fronteinbau Vierlochbefestigung	80
Fronteinbau Zentralbefestigung	84
Bodeneinbau Schnappbefestigung für Installationsverteiler	86
Bodeneinbau Schnappbefestigung mit Türverriegelung	88
Bodeneinbau Vierlochbefestigung mit Türverriegelung	96
Gekapselte Schalter mit Isolierstoffgehäuse	98
Gekapselte Schalter mit Isolierstoffgehäuse für EMV-Anwendung	103
Gekapselte Schalter mit Stahlgehäuse	104
Gekapselte Schalter mit Edelstahlgehäuse	107
Umschalter	109
Fronteinbau Vierlochbefestigung	109
Fronteinbau Zentralbefestigung	112
Bodeneinbau Schnappbefestigung für Installationsverteiler	113
Bodeneinbau Schnappbefestigung mit Türverriegelung	115
Bodeneinbau Vierlochbefestigung mit Türverriegelung	120
Gekapselte Schalter mit Isolierstoffgehäuse	122
Gekapselte Schalter mit Isolierstoffgehäuse für EMV-Anwendung	126
Gekapselte Schalter mit Stahlgehäuse	127
Gekapselte Schalter mit Edelstahlgehäuse	130
Technische Informationen	132
Schaltbilder	132
Zusatzmodule	141
Zubehör	145
Antriebe	149
Gebrauchskategorien	151
Motorbemessungsströme von Drehstrommotoren	152
Schutzarten	153
Technische Daten	154
Bauformverzeichnis	156
Ansprechpartner	158

Info

Neu in diesem Katalog:

Info

Neue Produktreihe B200 – Typen B240, B250 und B263

Die neue Produktreihe B200 von Sälzer ist eine Weiterentwicklung des bewährten Lasttrennschalters H263 und wurde analog zur Produktreihe H200 als Ein-/Ausschalter in 3-poliger bis 8-poliger Ausführung und als Umschalter in 3-poliger und 4-poliger Ausführung konzipiert. Mit neuen robusten und großzügigen Anschlussklemmen für einen maximalen Anschlussquerschnitt vom 25mm² ergeben sich wesentliche Vorteile zum H263, der einen maximalen Anschlussquerschnitt von 16mm² besitzt. Damit bietet die neue Reihe B200 eine Lösung für die in vielen Bereichen gestiegenen Anforderungen an die Anschlussstechnik. Alternativ bleibt der H263 bis auf weiteres lieferbar.

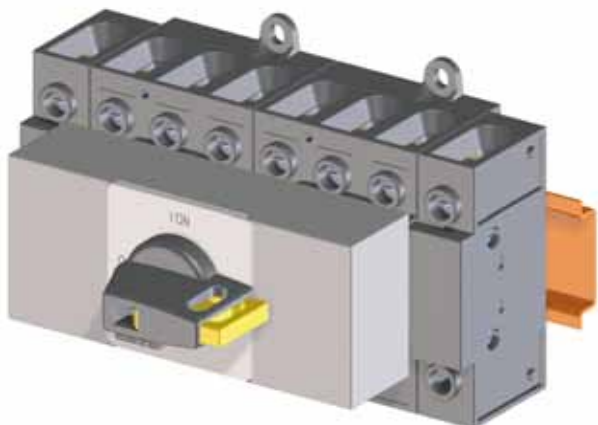

8-poliger Ein-/Ausschalter

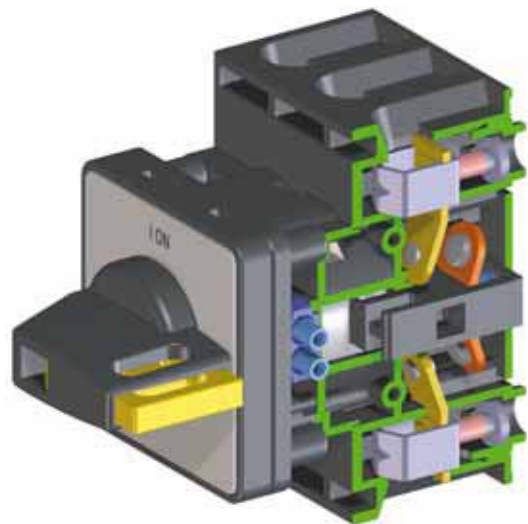

3-poliger Ein-/Ausschalter als Querschnitt

Innerhalb der Produktreihe B200 werden derzeit drei Typen angeboten:

- **B240** = 40A Betriebsstrom nach AC-21A,
15 kW Betriebsleistung nach AC-23A
bei 380-400 V
- **B250** = 50A Betriebsstrom nach AC-21A,
18,5 kW Betriebsleistung nach AC-23A
bei 380-400 V
- **B263** = 63A Betriebsstrom nach AC-21A,
22 kW Betriebsleistung nach AC-23A
bei 380-400 V.

Neben einem kompakten Design bieten beide Typen in gleicher Baugröße eine zusätzliche Sicherheit durch zwangsweises Öffnen und zwangsgeführtes Schließen der Kontakte.

Alle bewährten Bauformen und Zusatzeinrichtungen für Front- und Bodeneinbau der Baugröße 200 sind verwendbar und mit Neutralleitermodul, Hilfskontaktmodulen und N-/PE-Klemmen kombinierbar.

⇒ Weitere Informationen ab Seite 12.

Gekapselte Schalter mit Isolierstoffgehäuse für EMV-Anwendung

Verbindungssystem zur unterbrechungsfreien Durchführung abgeschirmter Kabel

In den letzten Jahren hat die EMV-Richtlinie wachsende Bedeutung erlangt. Sälzer Electric hat ein Isolierstoffgehäuse mit Verbindungssystem zur unterbrechungsfreien Durchführung abgeschirmter Kabel entwickelt. Diese Gehäuseausführung wird auch als EMV-/EMC-Gehäuse bezeichnet. In Verbindung mit geschirmtem Kabel wird eine Abschirmung des gesamten Systems gegen elektromagnetische Felder erreicht.

Das Isolierstoffgehäuse aus Polycarbonat mit Deckelverriegelung in EIN-Stellung besitzt die Abmessungen 175×115×100 mm (H×B×T). Im Gehäuseunterteil befindet sich ein Schirmblech mit vier Klammern zur Aufnahme der Kabelabschirmung.

Folgende Lasttrennschalter werden in diesem Gehäuse angeboten:



3-poliger Haupt-/Notausschalter mit Isolierstoffgehäuse für EMV-Anwendung

- Typen **H216, H220, H226** und **H233** als
 - ⇒ 2-, 3- und 4-polige Haupt-/Notausschalter bzw. Hauptschalter
 - ⇒ 6-polige Haupt-/Notausschalter bzw. Hauptschalter
 - ⇒ 3- und 4-polige Ein-/Ausschalter
 - ⇒ 6-polige Ein-/Ausschalter
 - ⇒ 2- und 3-polige Umschalter
- Typen **B240, B250** und **B263** als
 - ⇒ 2-, 3- und 4-polige Haupt-/Notausschalter bzw. Hauptschalter
 - ⇒ 3- und 4-polige Ein-/Ausschalter.

⇒ Weitere Informationen auf Seiten 37, 71, 103 und 126.

Lasttrennschalter



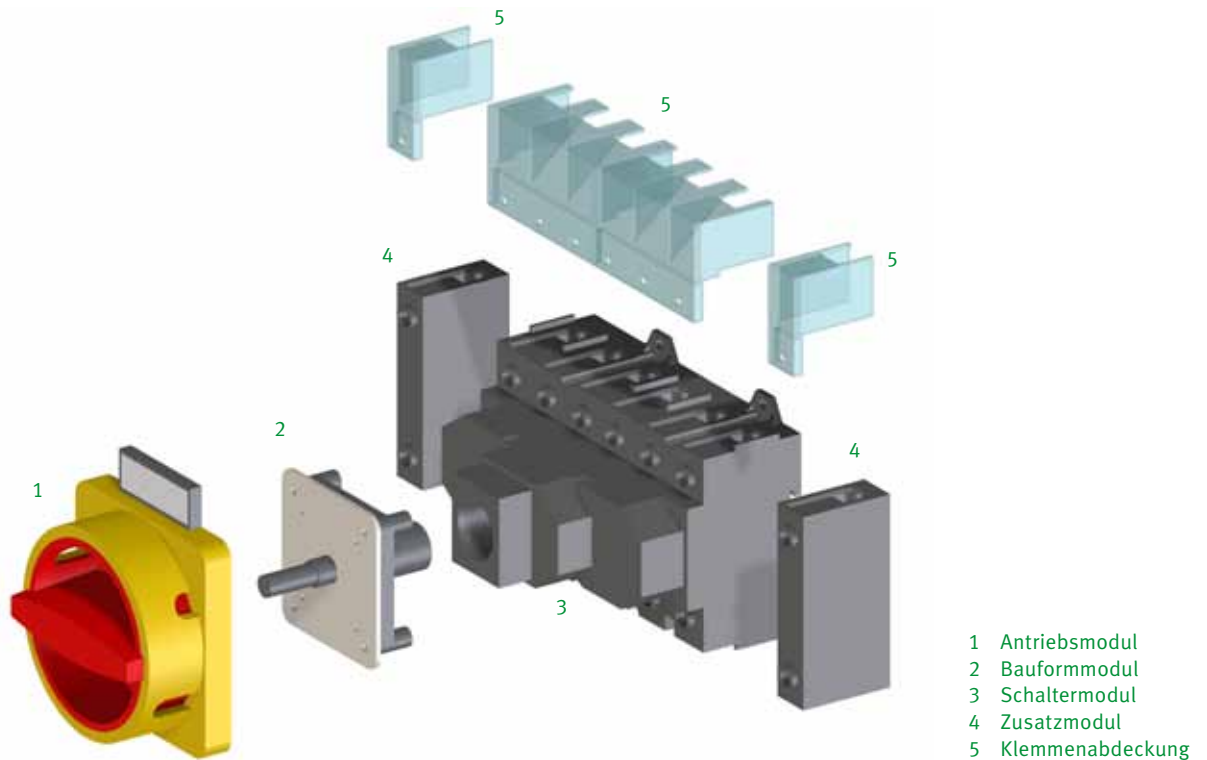

Lasttrennschalter

Sicheres Schalten und Trennen

Lasttrennschalter von Sälzer Electric sind handbetätigte Schaltgeräte für Hauptstromkreise mit einem Schaltwinkel von 90° und werden als Ein-/Ausschalter (2-, 3-, 4-, 6- und 8-polig) oder als Umschalter mit Nullstellung (2-, 3- und 4-polig) angeboten.

Aufbau und Funktion

- 90° Schaltwinkel
- zwangsläufig geöffnete Kontakte
- Berührungsschutz fingersicher (Schutzart bis IP20)
- hohe Kurzschlussfestigkeit
- Erfüllung der Trenneigenschaften bis 690 Volt bzw. bis 1000 Volt
- geöffnete Anschlussklemmen

Anwendungsbereiche

Lasttrennschalter bieten ideale Leistungsmerkmale für den Einsatz als:

- Ein-/Ausschalter
- Netztrenneinrichtung (Hauptschalter)
- Notausschalter
- Reparaturschalter
- Sicherheitsschalter
- Verteilerschalter
- Motorschalter

Konformität

Unsere Produkte werden nach folgenden Normen entwickelt, produziert und geprüft:

- IEC 60947
- IEC 60204-1
- EN 60947
- EN 60204-1
- cUL 508

Lasttrennschalter

Produktübersicht

Einbauvarianten:



Fronteinbau

- Vierlochbefestigung
- Zentralbefestigung



Bodeneinbau

- Schnappbefestigung
- Vierlochbefestigung



Gekapselte Schalter

- Isolierstoffgehäuse
- Stahlgehäuse
- Edelstahlgehäuse

Durch praxisgerechte Montagearten sowie durch eine große Kombinationsvielfalt der Antriebsmodule in Form und Farbe sind Lasttrennschalter vielseitig einsetzbar!

Alle Produkte sind in verschiedenen Ausführungen erhältlich!

Aufbau der Bestellnummer:

Die 16-stellige Bestellnummer eines Komplettschalters setzt sich aus den drei Identnummern für Typ, Schaltprogramm und Bauform zusammen:



- der **Typ** legt die Baugröße und die Leistungsdaten fest
- das **Schaltprogramm** definiert die Schaltung und den Schaltwinkel
- die **Bauform** bestimmt die Einbauart, die Zusatzeinrichtung und den Antrieb.

Jedem Komplettschalter wird zusätzlich zur Bestellnummer ein maschinenlesbarer 13-stelliger EAN-Code zugeordnet.

Bestellbeispiel:



Bestellnummer: H216 - 71300 - 214V1

- **Typ H216**
für einen Schalter der Baureihe H200, Betriebsstrom $I_e = 20 \text{ A}$
- **Schaltprogramm 71300**
für einen 3-poligen Umschalter ohne Hilfskontakte
- **Bauform 214V1**
für einen Fronteinbauswitcher mit Zentralbefestigung $\varnothing 22,5 \text{ mm}$ und V-Griff (silber/schwarz) mit Griffverriegelung.

Auf den einzelnen Produktseiten sind alle Kombinationsmöglichkeiten mit den gängigen Schaltprogrammen bereits aufgelistet, so dass Sie lediglich die Bestellnummer für den Komplettschalter auszuwählen brauchen.

Weitere Schaltprogramme finden Sie ab Seite 132. Für die Festlegung der neuen Bestellnummer muss die Identnummer des Schaltprogramms dann durch die Nummer der neuen Auswahl ersetzt werden.







Lasttrennschalter



Haupt-/Notausschalter Fronteinbau Vierlochbefestigung

Haupt-/Notausschalter

- Fronteinbauschalter mit Vierlochbefestigung
- 3- bis 8-polig
- 20 A bis 315 A
- IP66 / IP55







Schaltprogramm	Bemessungsdaten (IEC 60947) Betriebs- Betriebsleistung strom I _e (bei 380–440 V)			Befestigungsmaß (mm)	Vorhängeschlossperre N-Griff gelb/rot	Vorhängeschlossperre M-Griff gelb/rot	Griffverriegelung V-Griff gelb/rot
	AC-21A (A)	AC-23A (kW)	AC-3 (kW)		 	 	 
					IP66	IP66	IP66
					Bestellnummer	Bestellnummer	Bestellnummer
41300 – 3-polig – ohne Hilfskontakte 	20	5,5	3,7	36 × 36	H216-41300-033N4	H216-41300-033M4	H216-41300-033V4
	20	5,5	3,7	48 × 48	H216-41300-036N4	H216-41300-036M4	H216-41300-036V4
	25	7,5	5,5	36 × 36	H220-41300-033N4	H220-41300-033M4	H220-41300-033V4
	25	7,5	5,5	48 × 48	H220-41300-036N4	H220-41300-036M4	H220-41300-036V4
	32	11	7,5	36 × 36	H226-41300-033N4	H226-41300-033M4	H226-41300-033V4
	32	11	7,5	48 × 48	H226-41300-036N4	H226-41300-036M4	H226-41300-036V4
	40	15	11	36 × 36	H233-41300-033N4	H233-41300-033M4	H233-41300-033V4
	40	15	11	36 × 36	B240-41300-033N4*	B240-41300-033M4*	B240-41300-033V4*
	40	15	11	48 × 48	H233-41300-036N4	H233-41300-036M4	H233-41300-036V4
	40	15	11	48 × 48	B240-41300-036N4*	B240-41300-036M4*	B240-41300-036V4*
	40	15	11	68 × 68	B240-41300-136N4	B240-41300-136M4	–
	50	18,5	15	36 × 36	B250-41300-033N4	B250-41300-033M4	B250-41300-033V4
	50	18,5	15	48 × 48	B250-41300-036N4	B250-41300-036M4	B250-41300-036V4
	50	18,5	15	68 × 68	B250-41300-136N4	B250-41300-136M4	–
	63	22	18,5	36 × 36	B263-41300-033N4	B263-41300-033M4	B263-41300-033V4
	63	22	18,5	48 × 48	B263-41300-036N4	B263-41300-036M4	B263-41300-036V4
	63	22	18,5	48 × 48	H406-41300-033N4*	H406-41300-033M4*	H406-41300-033V4*
	63	22	18,5	68 × 68	B263-41300-136N4	B263-41300-136M4	–
	63	22	18,5	68 × 68	H406-41300-036N4*	H406-41300-036M4*	–
	80	30	22	48 × 48	H408-41300-033N4	H408-41300-033M4	H408-41300-033V4
80	30	22	68 × 68	H408-41300-036N4	H408-41300-036M4	–	
100	37	30	48 × 48	H410-41300-033N4	H410-41300-033M4	H410-41300-033V4	
100	37	30	68 × 68	H410-41300-036N4	H410-41300-036M4	–	
125	45	37	48 × 48	H412-41300-033N4	H412-41300-033M4	H412-41300-033V4	
125	45	37	68 × 68	H412-41300-036N4	H412-41300-036M4	–	

Bemessungsdaten (IEC 60947) Betriebs- Betriebsleistung strom I _e (bei 380–440 V)			Befestigungsmaß (mm)	Vorhängeschlossperre H-Griff gelb/rot	Bestellnummer
AC-21A (A)	AC-23A (kW)	AC-3 (kW)		 	
160	75	45	68 × 68	IP55	K616-41300-033H4
315	132	55	104 × 104		K830-41300-033H4

* größerer Anschlussquerschnitt, siehe Seite 154

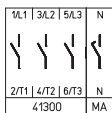
Weitere Schaltprogramme ab Seite 132.

Schaltprogramm	Bemessungsdaten (IEC 60947) Betriebsstrom I_e Betriebsleistung (bei 380–440 V)			Befestigungsmaß (mm)	Vorhängeschlossperre N-Griff gelb/rot	Vorhängeschlossperre M-Griff gelb/rot	Griffverriegelung V-Griff gelb/rot
	AC-21A (A)	AC-23A (kW)	AC-3 (kW)		 OFF ON IP66	 ON IP66	 ON IP66
					Bestellnummer	Bestellnummer	Bestellnummer
41400 – 4-polig – ohne Hilfskontakte – Neutralleiter voreilend 	20	5,5	3,7	36 × 36	H216-41400-033N4	H216-41400-033M4	H216-41400-033V4
	20	5,5	3,7	48 × 48	H216-41400-036N4	H216-41400-036M4	H216-41400-036V4
	25	7,5	5,5	36 × 36	H220-41400-033N4	H220-41400-033M4	H220-41400-033V4
	25	7,5	5,5	48 × 48	H220-41400-036N4	H220-41400-036M4	H220-41400-036V4
	32	11	7,5	36 × 36	H226-41400-033N4	H226-41400-033M4	H226-41400-033V4
	32	11	7,5	48 × 48	H226-41400-036N4	H226-41400-036M4	H226-41400-036V4
	40	15	11	36 × 36	H233-41400-033N4	H233-41400-033M4	H233-41400-033V4
	40	15	11	36 × 36	B240-41400-033N4*	B240-41400-033M4*	B240-41400-033V4*
	40	15	11	48 × 48	H233-41400-036N4	H233-41400-036M4	H233-41400-036V4
	40	15	11	48 × 48	B240-41400-036N4*	B240-41400-036M4*	B240-41400-036V4*
	40	15	11	68 × 68	B240-41400-136N4	B240-41400-136M4	–
	50	18,5	15	36 × 36	B250-41400-033N4	B250-41400-033M4	B250-41400-033V4
	50	18,5	15	48 × 48	B250-41400-036N4	B250-41400-036M4	B250-41400-036V4
	50	18,5	15	68 × 68	B250-41400-136N4	B250-41400-136M4	–
	63	22	18,5	36 × 36	B263-41400-033N4	B263-41400-033M4	B263-41400-033V4
	63	22	18,5	48 × 48	B263-41400-036N4	B263-41400-036M4	B263-41400-036V4
	63	22	18,5	48 × 48	H406-41400-033N4*	H406-41400-033M4*	H406-41400-033V4*
	63	22	18,5	68 × 68	B263-41400-136N4	B263-41400-136M4	–
	63	22	18,5	68 × 68	H406-41400-036N4*	H406-41400-036M4*	–
	80	30	22	48 × 48	H408-41400-033N4	H408-41400-033M4	H408-41400-033V4
80	30	22	68 × 68	H408-41400-036N4	H408-41400-036M4	–	
100	37	30	48 × 48	H410-41400-033N4	H410-41400-033M4	H410-41400-033V4	
100	37	30	68 × 68	H410-41400-036N4	H410-41400-036M4	–	
125	45	37	48 × 48	H412-41400-033N4	H412-41400-033M4	H412-41400-033V4	
125	45	37	68 × 68	H412-41400-036N4	H412-41400-036M4	–	



Bemessungsdaten (IEC 60947) Betriebsstrom I_e Betriebsleistung (bei 380–440 V)			Befestigungsmaß (mm)	Vorhängeschlossperre H-Griff gelb/rot	Bestellnummer
AC-21A (A)	AC-23A (kW)	AC-3 (kW)		 ON IP55	
160	75	45	68 × 68	K616-41400-033H4	
315	132	55	104 × 104	K830-41400-033H4	

* größerer Anschlussquerschnitt, siehe Seite 154

Weitere Schaltprogramme ab Seite 132.

Lasttrennschalter

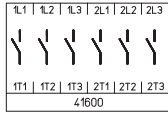

Haupt-/Notausschalter Fronteinbau Vierlochbefestigung

Schaltprogramm	Bemessungsdaten (IEC 60947) Betriebsstrom I_e Betriebsleistung (bei 380–440 V)			Befestigungsmaß (mm)	Vorhängeschlossperre N-Griff gelb/rot	Vorhängeschlossperre M-Griff gelb/rot	Griffverriegelung V-Griff gelb/rot
	AC-21A (A)	AC-23A (kW)	AC-3 (kW)				
					IP66	IP66	IP66
				Bestellnummer	Bestellnummer	Bestellnummer	
41600 – 6-polig – ohne Hilfskontakte 	20	5,5	3,7	36 × 36	H216-41600-033N4	H216-41600-033M4	–
	20	5,5	3,7	48 × 48	H216-41600-036N4	H216-41600-036M4	H216-41600-036V4
	20	5,5	3,7	68 × 68	H216-41600-136N4	H216-41600-136M4	–
	25	7,5	5,5	36 × 36	H220-41600-033N4	H220-41600-033M4	–
	25	7,5	5,5	48 × 48	H220-41600-036N4	H220-41600-036M4	H220-41600-036V4
	25	7,5	7,5	68 × 68	H220-41600-136N4	H220-41600-136M4	–
	32	11	7,5	36 × 36	H226-41600-033N4	H226-41600-033M4	–
	32	11	7,5	48 × 48	H226-41600-036N4	H226-41600-036M4	H226-41600-036V4
	32	11	7,5	68 × 68	H226-41600-136N4	H226-41600-136M4	–
	40	15	11	36 × 36	H233-41600-033N4	H233-41600-033M4	–
	40	15	11	36 × 36	B240-41600-033N4*	B240-41600-033M4*	–
	40	15	11	48 × 48	H233-41600-036N4	H233-41600-036M4	H233-41600-036V4
	40	15	11	48 × 48	B240-41600-036N4*	B240-41600-036M4*	B240-41600-036V4
	40	15	11	68 × 68	H233-41600-136N4	H233-41600-136M4	–
	40	15	11	68 × 68	B240-41600-136N4*	B240-41600-136M4*	–
	50	18,5	15	36 × 36	B250-41600-033N4	B250-41600-033M4	–
	50	18,5	15	48 × 48	B250-41600-036N4	B250-41600-036M4	B250-41600-036V4
	50	18,5	15	68 × 68	B250-41600-136N4	B250-41600-136M4	–
	63	22	18,5	36 × 36	B263-41600-033N4	B263-41600-033M4	–
	63	22	18,5	48 × 48	B263-41600-036N4	B263-41600-036M4	B263-41600-036V4
	63	22	18,5	48 × 48	H406-41600-033N4*	H406-41600-033M4*	H406-41600-033V4*
	63	22	18,5	68 × 68	B263-41600-136N4	B263-41600-136M4	–
	63	22	18,5	68 × 68	H406-41600-036N4*	H406-41600-036M4*	–
	80	30	22	48 × 48	H408-41600-033N4	H408-41600-033M4	H408-41600-033V4
80	30	22	68 × 68	H408-41600-036N4	H408-41600-036M4	–	
100	37	30	48 × 48	H410-41600-033N4	H410-41600-033M4	H410-41600-033V4	
100	37	30	68 × 68	H410-41600-036N4	H410-41600-036M4	–	
125	45	37	48 × 48	H412-41600-033N4	H412-41600-033M4	H412-41600-033V4	
125	45	37	68 × 68	H412-41600-036N4	H412-41600-036M4	–	

Bemessungsdaten (IEC 60947) Betriebsstrom I_e Betriebsleistung (bei 380–440 V)			Befestigungsmaß (mm)	Vorhängeschlossperre H-Griff gelb/rot
AC-21A (A)	AC-23A (kW)	AC-3 (kW)		
				IP55
			Bestellnummer	
160	75	45	68 × 68	K616-41600-033H4
315	132	55	104 × 104	K830-41600-033H4

* größerer Anschlussquerschnitt, siehe Seite 154

Weitere Schaltprogramme ab Seite 132.

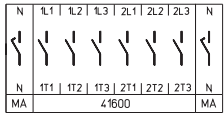
Schaltprogramm	Bemessungsdaten (IEC 60947) Betriebsstrom I_e Betriebsleistung (bei 380–440 V)			Befestigungsmaß (mm)	Vorhängeschlossperre mit N-Griff gelb/rot	Vorhängeschlossperre M-Griff gelb/rot	Griffverriegelung V-Griff gelb/rot
	AC-21A (A)	AC-23A (kW)	AC-3 (kW)		 IP66	 IP66	 IP66
					Bestellnummer	Bestellnummer	Bestellnummer
41800 – 8-polig – ohne Hilfskontakte – 2 Neutralleiter voreilend 	20	5,5	3,7	36 × 36	H216-41800-033N4	H216-41800-033M4	–
	20	5,5	3,7	48 × 48	H216-41800-036N4	H216-41800-036M4	H216-41800-036V4
	20	5,5	3,7	68 × 68	H216-41800-136N4	H216-41800-136M4	–
	25	7,5	5,5	36 × 36	H220-41800-033N4	H220-41800-033M4	–
	25	7,5	5,5	48 × 48	H220-41800-036N4	H220-41800-036M4	H220-41800-036V4
	25	7,5	5,5	68 × 68	H220-41800-136N4	H220-41800-136M4	–
	32	11	7,5	36 × 36	H226-41800-033N4	H226-41800-033M4	–
	32	11	7,5	48 × 48	H226-41800-036N4	H226-41800-036M4	H226-41800-036V4
	32	11	7,5	68 × 68	H226-41800-136N4	H226-41800-136M4	–
	40	15	11	36 × 36	H233-41800-033N4	H233-41800-033M4	–
	40	15	11	36 × 36	B240-41800-033N4*	B240-41800-033M4*	–
	40	15	11	48 × 48	H233-41800-036N4	H233-41800-036M4	H233-41800-036V4
	40	15	11	48 × 48	B240-41800-036N4*	B240-41800-036M4*	B240-41800-036V4*
	40	15	11	68 × 68	H233-41800-136N4	H233-41800-136M4	–
	40	15	11	68 × 68	B240-41800-136N4*	B240-41800-136M4*	–
	50	18,5	15	36 × 36	B250-41800-033N4	B250-41800-033M4	–
	50	18,5	15	48 × 48	B250-41800-036N4	B250-41800-036M4	B250-41800-036V4
	50	18,5	15	68 × 68	B250-41800-136N4	B250-41800-136M4	–
	63	22	18,5	36 × 36	B263-41800-033N4	B263-41800-033M4	–
	63	22	18,5	48 × 48	B263-41800-036N4	B263-41800-036M4	B263-41800-036V4
63	22	18,5	48 × 48	H406-41800-033N4*	H406-41800-033M4*	H406-41800-033V4*	
63	22	18,5	68 × 68	B263-41800-136N4	B263-41800-136M4	–	
63	22	18,5	68 × 68	H406-41800-036N4*	H406-41800-036M4*	–	
80	30	22	48 × 48	H408-41800-033N4	H408-41800-033M4	H408-41800-033V4	
80	30	22	68 × 68	H408-41800-036N4	H408-41800-036M4	–	
100	37	30	48 × 48	H410-41800-033N4	H410-41800-033M4	H410-41800-033V4	
100	37	30	68 × 68	H410-41800-036N4	H410-41800-036M4	–	
125	45	37	48 × 48	H412-41800-033N4	H412-41800-033M4	H412-41800-033V4	
125	45	37	68 × 68	H412-41800-036N4	H412-41800-036M4	–	

Bemessungsdaten (IEC 60947) Betriebsstrom I_e Betriebsleistung (bei 380–440 V)			Befestigungsmaß (mm)	Vorhängeschlossperre H-Griff gelb/rot
AC-21A (A)	AC-23A (kW)	AC-3 (kW)		 IP55
				Bestellnummer
160	75	45	68 × 68	K616-41800-033H4
315	132	55	104 × 104	K830-41800-033H4

* größerer Anschlussquerschnitt, siehe Seite 154

Weitere Schaltprogramme ab Seite 132.

Lasttrennschalter

Haupt-/Notausschalter Fronteinbau Vierlochbefestigung

Abmessungen in mm:

Aufbau der Bestellnummer		
Typ	Schaltprogramm	Bauform
H216	41800	036N4
Best.-Nr. H216-41800-036N4		

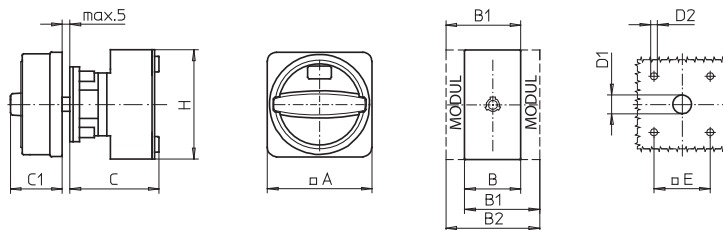

Schaltprogramme 3- und 4-polig

Typen H216 / H220 / H226 / H233:

Bauform	A	B	B1	B2	C	C1	D1	D2	E	H
033M4	67	36	48	60	58	38	15	4,5	36	70
033N4	67	36	48	60	58	33	15	4,5	36	70
033V4	48	36	48	60	58	32	12	4,5	36	70
036M4	67	36	48	60	58	38	15	5	48	70
036N4	67	36	48	60	58	33	15	5	48	70
036V4	64	36	48	60	58	39	15	5	48	70

Typen B240 / B250 / B263:

Bauform	A	B	B1	B2	C	C1	D1	D2	E	H
033M4	67	50	69	88	58	38	15	4,5	36	72
033N4	67	50	69	88	58	33	15	4,5	36	72
033V4	48	50	69	88	58	32	12	4,5	36	72
036M4	67	50	69	88	58	38	15	5	48	72
036N4	67	50	69	88	58	33	15	5	48	72
036V4	64	50	69	88	58	39	15	5	48	72
136M4	88	50	69	88	58	50	15	5,5	68	72
136N4	88	50	69	88	58	45	15	5,5	68	72

Typen H406 / H408 / H410 / H412:

Bauform	A	B	B1	B2	C	C1	D1	D2	E	H
033M4	88	70	89	108	73	50	15	5	48	80
033N4	88	70	89	108	73	45	15	5	48	80
033V4	64	70	89	108	73	39	15	5	48	80
036M4	88	70	89	108	73	50	15	5,5	68	80
036N4	88	70	89	108	73	45	15	5,5	68	80

Schaltprogramme 6- und 8-polig

Typen H216 / H220 / H226 / H233:

Bauform	A	B	B1	B2	C	C1	D1	D2	E	H
033M4	67	72	84	96	66	38	15	4,5	36	70
033N4	67	72	84	96	66	33	15	4,5	36	70
036M4	67	72	84	96	66	38	15	5	48	70
036N4	67	72	84	96	66	33	15	5	48	70
036V4	64	72	84	96	66	39	15	5	48	70
136M4	88	72	84	96	66	38	15	5,5	68	70
136N4	88	72	84	96	66	33	15	5,5	68	70

Typen B240 / B250 / B263:

Bauform	A	B	B1	B2	C	C1	D1	D2	E	H
033M4	67	100	119	138	70	38	15	4,5	36	72
033N4	67	100	119	138	70	33	15	4,5	36	72
036M4	67	100	119	138	70	38	15	5	48	72
036N4	67	100	119	138	70	33	15	5	48	72
036V4	64	100	119	138	70	39	15	5	48	72
136M4	88	100	119	138	70	50	15	5,5	68	72
136N4	88	100	119	138	70	45	15	5,5	68	72

Typen H406 / H408 / H410 / H412:

Bauform	A	B	B1	B2	C	C1	D1	D2	E	H
033M4	88	140	159	178	86	50	15	5	48	80
033N4	88	140	159	178	86	45	15	5	48	80
033V4	64	140	159	178	86	39	15	5	48	80
036M4	88	140	159	178	86	50	15	5,5	68	80
036N4	88	140	159	178	86	45	15	5,5	68	80

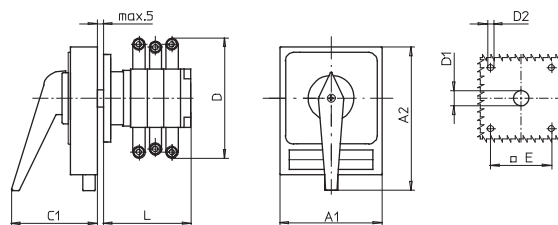

Typen K616 / K830:

Typ	Bauform	Schaltprogramm	A1	A2	C1	D*	D1	D2	E	L
K616	033H4	41300	98	142	83	150	20	5,5	68	104
K616	033H4	41400	98	142	83	150	20	5,5	68	104
K830	033H4	41300	130	178	93	210	20	5,5	104	125
K830	033H4	41400	130	178	93	210	20	5,5	104	125

Typen K616 / K830:

Typ	Bauform	Schaltprogramm	A1	A2	C1	D*	D1	D2	E	L
K616	033H4	41600	98	142	83	150	20	5,5	68	136
K616	033H4	41800	98	142	83	150	20	5,5	68	168
K830	033H4	41600	130	178	93	210	20	5,5	104	161
K830	033H4	41800	130	178	93	210	20	5,5	104	197

Weitere Schaltprogramme und zugehörige Abmessungen für Typen K auf Anfrage.

* einschließlich Anschlusswinkel

Haupt-/Notausschalter

- Fronteinbauschalter mit Zentralbefestigung
- 3- bis 8-polig
- 20 A bis 63 A
- IP66



Schaltprogramm	Bemessungsdaten (IEC 60947) Betriebs- Betriebsleistung strom I _e (bei 380–440 V)			Befestigungsmaß (mm)	Vorhängeschlossperre N-Griff gelb/rot	Vorhängeschlossperre M-Griff gelb/rot	Griffverriegelung V-Griff gelb/rot
	AC-21A (A)	AC-23A (kW)	AC-3 (kW)				
					IP66	IP66	IP66
					Bestellnummer	Bestellnummer	Bestellnummer
41300 – 3-polig – ohne Hilfskontakte 	20	5,5	3,7	∅ 22,5	H216-41300-206N4	H216-41300-206M4	H216-41300-206V4
	20	5,5	3,7	∅ 30,5	H216-41300-216N4	H216-41300-216M4	H216-41300-216V4
	25	7,5	5,5	∅ 22,5	H220-41300-206N4	H220-41300-206M4	H220-41300-206V4
	25	7,5	5,5	∅ 30,5	H220-41300-216N4	H220-41300-216M4	H220-41300-216V4
	32	11	7,5	∅ 22,5	H226-41300-206N4	H226-41300-206M4	H226-41300-206V4
	32	11	7,5	∅ 30,5	H226-41300-216N4	H226-41300-216M4	H226-41300-216V4
	40	15	11	∅ 22,5	H233-41300-206N4	H233-41300-206M4	H233-41300-206V4
	40	15	11	∅ 22,5	B240-41300-206N4*	B240-41300-206M4*	B240-41300-206V4*
	40	15	11	∅ 30,5	H233-41300-216N4	H233-41300-216M4	H233-41300-216V4
	40	15	11	∅ 30,5	B240-41300-216N4*	B240-41300-216M4*	B240-41300-216V4*
	50	18,5	15	∅ 22,5	B250-41300-206N4	B250-41300-206M4	B250-41300-206V4
	50	18,5	15	∅ 30,5	B250-41300-216N4	B250-41300-216M4	B250-41300-216V4
	63	22	18,5	∅ 22,5	B263-41300-206N4	B263-41300-206M4	B263-41300-206V4
	63	22	18,5	∅ 30,5	B263-41300-216N4	B263-41300-216M4	B263-41300-216V4







41400 – 4-polig – ohne Hilfskontakte – Neutralleiter voreilend 	20	5,5	3,7	∅ 22,5	H216-41400-206N4	H216-41400-206M4	H216-41400-206V4
	20	5,5	3,7	∅ 30,5	H216-41400-216N4	H216-41400-216M4	H216-41400-216V4
	25	7,5	5,5	∅ 22,5	H220-41400-206N4	H220-41400-206M4	H220-41400-206V4
	25	7,5	5,5	∅ 30,5	H220-41400-216N4	H220-41400-216M4	H220-41400-216V4
	32	11	7,5	∅ 22,5	H226-41400-206N4	H226-41400-206M4	H226-41400-206V4
	32	11	7,5	∅ 30,5	H226-41400-216N4	H226-41400-216M4	H226-41400-216V4
	40	15	11	∅ 22,5	H233-41400-206N4	H233-41400-206M4	H233-41400-206V4
	40	15	11	∅ 22,5	B240-41400-206N4*	B240-41400-206M4*	B240-41400-206V4*
	40	15	11	∅ 30,5	H233-41400-216N4	H233-41400-216M4	H233-41400-216V4
	40	15	11	∅ 30,5	B240-41400-216N4*	B240-41400-216M4*	B240-41400-216V4*
	50	18,5	15	∅ 22,5	B250-41400-206N4	B250-41400-206M4	B250-41400-206V4
	50	18,5	15	∅ 30,5	B250-41400-216N4	B250-41400-216M4	B250-41400-216V4
	63	22	18,5	∅ 22,5	B263-41400-206N4	B263-41400-206M4	B263-41400-206V4
	63	22	18,5	∅ 30,5	B263-41400-216N4	B263-41400-216M4	B263-41400-216V4

* größerer Anschlussquerschnitt, siehe Seite 154

Weitere Schaltprogramme ab Seite 132.

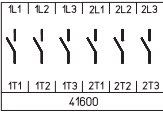
Lasttrennschalter

Haupt-/Notausschalter Fronteinbau Zentralbefestigung

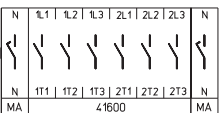
Schaltprogramm	Bemessungsdaten (IEC 60947) Betriebsstrom I_e Betriebsleistung (bei 380–440 V)			Befestigungsmaß (mm)	Vorhängeschlossperre N-Griff gelb/rot	Vorhängeschlossperre M-Griff gelb/rot	Griffverriegelung V-Griff gelb/rot
	AC-21A (A)	AC-23A (kW)	AC-3 (kW)				
41600 – 6-polig – ohne Hilfskontakte 	20	5,5	3,7	∅ 22,5			
	20	5,5	3,7	∅ 30,5	H216-41600-206N4	H216-41600-206M4	–
	25	7,5	5,5	∅ 22,5	H216-41600-216N4	H216-41600-216M4	H216-41600-216V4
	25	7,5	5,5	∅ 30,5	H220-41600-206N4	H220-41600-206M4	–
	25	7,5	5,5	∅ 30,5	H220-41600-216N4	H220-41600-216M4	H220-41600-216V4
	32	11	7,5	∅ 22,5	H226-41600-206N4	H226-41600-206M4	–
	32	11	7,5	∅ 30,5	H226-41600-216N4	H226-41600-216M4	H226-41600-216V4
	40	15	11	∅ 22,5	H233-41600-206N4	H233-41600-206M4	–
40	15	11	∅ 30,5	H233-41600-216N4	H233-41600-216M4	H233-41600-216V4	
41800 – 8-polig – ohne Hilfskontakte – 2 Neutralleiter voreilend 	20	5,5	3,7	∅ 22,5	H216-41800-206N4	H216-41800-206M4	–
	20	5,5	3,7	∅ 30,5	H216-41800-216N4	H216-41800-216M4	H216-41800-216V4
	25	7,5	5,5	∅ 22,5	H220-41800-206N4	H220-41800-206M4	–
	25	7,5	5,5	∅ 30,5	H220-41800-216N4	H220-41800-216M4	H220-41800-216V4
	32	11	7,5	∅ 22,5	H226-41800-206N4	H226-41800-206M4	–
	32	11	7,5	∅ 30,5	H226-41800-216N4	H226-41800-216M4	H226-41800-216V4
40	15	11	∅ 22,5	H233-41800-206N4	H233-41800-206M4	–	
40	15	11	∅ 30,5	H233-41800-216N4	H233-41800-216M4	H233-41800-216V4	

Weitere Schaltprogramme ab Seite 132.

Abmessungen in mm:

Aufbau der Bestellnummer		
Typ	Schaltprogramm	Bauform
H226	41300	206N4
Best.-Nr.	H226-41300-206N4	

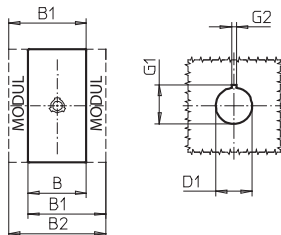
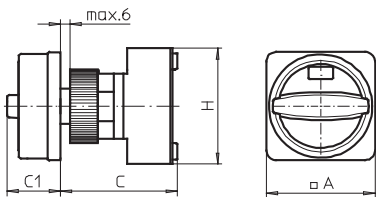

Schaltprogramme 3- und 4-polig

Typen H216 / H220 / H226 / H233:

Bauform	A	B	B1	B2	C	C1	D1	G1	G2	H
206M4	67	36	48	60	75	38	22,5	24,2	3,2	70
206N4	67	36	48	60	75	33	22,5	24,2	3,2	70
206V4	48	36	48	60	75	32	22,5	24,2	3,2	70
216M4	67	36	48	60	75	38	30,5	33	4,8	70
216N4	67	36	48	60	75	33	30,5	33	4,8	70
216V4	64	36	48	60	75	39	30,5	33	4,8	70

Typen B240 / B250 / B263:

Bauform	A	B	B1	B2	C	C1	D1	G1	G2	H
206M4	67	50	69	88	75	38	22,5	24,2	3,2	72
206N4	67	50	69	88	75	33	22,5	24,2	3,2	72
206V4	48	50	69	88	75	32	22,5	24,2	3,2	72
216M4	67	50	69	88	75	38	30,5	33	4,8	72
216N4	67	50	69	88	75	33	30,5	33	4,8	72
216V4	64	50	69	88	75	39	30,5	33	4,8	72

Schaltprogramme 6- und 8-polig





Typen H216 / H220 / H226 / H233:

Bauform	A	B	B1	B2	C	C1	D1	G1	G2	H
206M4	67	72	84	96	83	38	22,5	24,2	3,2	70
206N4	67	72	84	96	83	33	22,5	24,2	3,2	70
216M4	67	72	84	96	83	38	30,5	33	4,8	70
216N4	67	72	84	96	83	33	30,5	33	4,8	70
216V4	64	72	84	96	83	39	30,5	33	4,8	70

Haupt-/Notausschalter

- Bodeneinbauschalter mit Schnappbefestigung
- für Installationsverteiler
- 3- bis 8-polig
- 20 A bis 125 A
- IP30

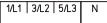
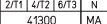

Schaltprogramm	Bemessungsdaten (IEC 60947) Betriebs- Betriebsleistung strom I _e (bei 380–440 V)			Frontschildmaß für Normausschnitt 45 mm (H × B) (mm)	Griffverriegelung V-Griff gelb/rot   IP30	Bestellnummer
	AC-21A (A)	AC-23A (kW)	AC-3 (kW)			
41300 – 3-polig – ohne Hilfskontakte   41300	20	5,5	3,7	45 × 48		H216-41300-026V4
	20	5,5	3,7	45 × 60		H216-41300-126V4
	25	7,5	5,5	45 × 48		H220-41300-026V4
	25	7,5	5,5	45 × 60		H220-41300-126V4
	32	11	7,5	45 × 48		H226-41300-026V4
	32	11	7,5	45 × 60		H226-41300-126V4
	40	15	11	45 × 48		H233-41300-026V4
	40	15	11	45 × 52,5		B240-41300-026V4*
	40	15	11	45 × 60		H233-41300-126V4
	50	18,5	15	45 × 52,5		B250-41300-026V4
	63	22	18,5	45 × 52,5		B263-41300-026V4
	63	22	18,5	45 × 72		H406-41300-126V4*
	80	30	22	45 × 72		H408-41300-126V4
	100	37	30	45 × 72		H410-41300-126V4
125	45	37	45 × 72		H412-41300-126V4	
41400 – 4-polig – ohne Hilfskontakte – Neutralleiter voreilend   41400 MA	20	5,5	3,7	45 × 48		H216-41400-026V4
	20	5,5	3,7	45 × 60		H216-41400-126V4
	25	7,5	5,5	45 × 48		H220-41400-026V4
	25	7,5	5,5	45 × 60		H220-41400-126V4
	32	11	7,5	45 × 48		H226-41400-026V4
	32	11	7,5	45 × 60		H226-41400-126V4
	40	15	11	45 × 48		H233-41400-026V4
	40	15	11	45 × 52,5		B240-41400-026V4*
	40	15	11	45 × 60		H233-41400-126V4
	50	18,5	15	45 × 52,5		B250-41400-026V4
	63	22	18,5	45 × 52,5		B263-41400-026V4
	63	22	18,5	45 × 72		H406-41400-126V4*
	80	30	22	45 × 72		H408-41400-126V4
	100	37	30	45 × 72		H410-41400-126V4
125	45	37	45 × 72		H412-41400-126V4	

* größerer Anschlussquerschnitt, siehe Seite 154

Weitere Schaltprogramme ab Seite 132.

Lasttrennschalter

Haupt-/Notausschalter **Bodeneinbau** Schnappbefestigung für Installationsverteiler

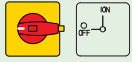
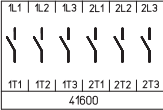
Schaltprogramm	Bemessungsdaten (IEC 60947) Betriebsstrom I_e Betriebsleistung (bei 380–440 V)			Frontschildmaß für Normausschnitt 45 mm (H × B) (mm)	Griffverriegelung V-Griff gelb/rot  IP30	Bestellnummer
	AC-21A (A)	AC-23A (kW)	AC-3 (kW)			
41600 – 6-polig – ohne Hilfskontakte 	20	5,5	3,7	45 × 76		H216-41600-026V4
	25	7,5	5,5	45 × 76		H220-41600-026V4
	32	11	7,5	45 × 76		H226-41600-026V4
	40	15	11	45 × 76		H233-41600-026V4
	40	15	11	45 × 105		B240-41600-026V4*
	50	18,5	15	45 × 105		B250-41600-026V4
	63	22	18,5	45 × 105		B263-41600-026V4
	63	22	18,5	45 × 72		H406-41600-126V4*
	80	30	22	45 × 72		H408-41600-126V4
	100	37	30	45 × 72		H410-41600-126V4
125	45	37	45 × 72		H412-41600-126V4	

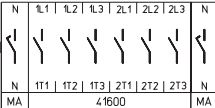
41800 – 8-polig – ohne Hilfskontakte – 2 Neutralleiter voreilend 	20	5,5	3,7	45 × 76		H216-41800-026V4
	25	7,5	5,5	45 × 76		H220-41800-026V4
	32	11	7,5	45 × 76		H226-41800-026V4
	40	15	11	45 × 76		H233-41800-026V4
	40	15	11	45 × 105		B240-41800-026V4*
	50	18,5	15	45 × 105		B250-41800-026V4
	63	22	18,5	45 × 105		B263-41800-026V4
	63	22	18,5	45 × 72		H406-41800-126V4*
	80	30	22	45 × 72		H408-41800-126V4
	100	37	30	45 × 72		H410-41800-126V4
125	45	37	45 × 72		H412-41800-126V4	

* größerer Anschlussquerschnitt, siehe Seite 154
Weitere Schaltprogramme ab Seite 132.

Abmessungen in mm:

Aufbau der Bestellnummer

Typ	Schaltprogramm	Bauform
H216	41300	026V4
Best.-Nr.	H216-41300-026V4	

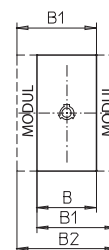
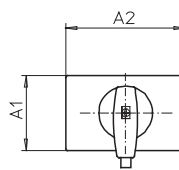
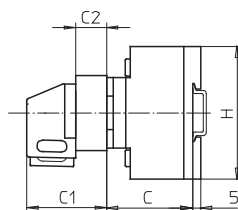

Schaltprogramme 3- und 4-polig

Typen H216 / H220 / H226 / H233:

Bauform	A1	A2	B	B1	B2	C	C1	C2	H
026V4	45	48	36	48	60	38	45	18,5	70
126V4	45	60	36	48	60	38	45	18,5	70

Typen B240 / B250 / B263:

Bauform	A1	A2	B	B1	B2	C	C1	C2	H
026V4	45	52,5	50	69	88	38	45	18,5	72

Typen H406 / H408 / H410 / H412:

Bauform	A1	A2	B	B1	B2	C	C1	C2	H
126V4	45	72	70	89	108	55	48	16	80

Schaltprogramme 6- und 8-polig

Typen H216 / H220 / H226 / H233:

Bauform	A1	A2	B	B1	B2	C	C1	C2	H
026V4	45	76	72	84	96	40	51,5	25,5	70

Typen B240 / B250 / B263:

Bauform	A1	A2	B	B1	B2	C	C1	C2	H
026V4	45	105	100	119	138	40	51,5	25,5	72

Typen H406 / H408 / H410 / H412:

Bauform	A1	A2	B	B1	B2	C	C1	C2	H
126V4	45	72	140	159	178	67	48	16	80

Lasttrennschalter

Haupt-/Notausschalter **Bodeneinbau** Schnappbefestigung mit Türverriegelung

Haupt-/Notausschalter

- Bodeneinbauschalter mit Schnappbefestigung
- Türverriegelung
- 3- bis 8-polig
- 20 A bis 125 A
- **IP66**
- mit Modular- bzw. Metallachsverlängerung
- Zentral- oder Vierlochbefestigung frontseitig



Bodeneinbauschalter mit Schnappbefestigung und Türverriegelung werden in zwei Verlängerungsvarianten angeboten:

1. Schalter mit **Modularachsverlängerung** können durch das Aufstecken zusätzlicher Module auf das benötigte Einbaumaß C verlängert werden. Die zugehörigen Verlängerungsbauteile finden Sie auf Seite 145.

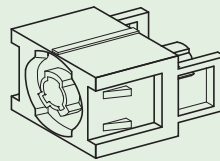
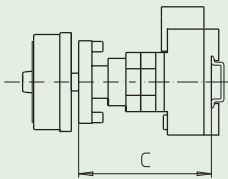

AVC2/AVC4
Modularachsverlängerung

2. Bei Schaltern mit **Metallachsverlängerung** ist die benötigte Metallachse nicht im Lieferumfang enthalten und muss getrennt bestellt werden. Angaben zum Einbaumaß C und zu den erhältlichen Ausführungen finden Sie auf Seite 146.

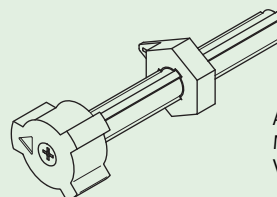
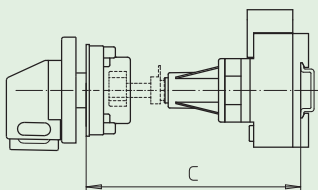

AVB8
Metallachsverlängerung für
Vierlochbefestigung (frontseitig)

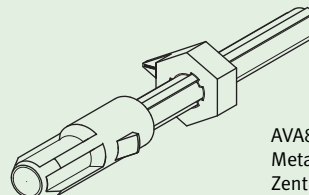
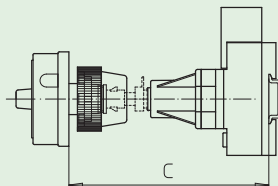

AVA8
Metallachsverlängerung für
Zentralbefestigung (frontseitig)

Lasttrennschalter

Haupt-/Notausschalter Bodeneinbau Schnappbefestigung mit Türverriegelung

Schaltprogramm	Bemessungsdaten (IEC 60947) Betriebsstrom I_e Betriebsleistung (bei 380–440 V)			Befestigungsmaß (frontseitig) (mm)	Vorhängeschlossperre N-Griff gelb/rot	Vorhängeschlossperre M-Griff gelb/rot	Griffverriegelung V-Griff gelb/rot
	AC-21A (A)	AC-23A (kW)	AC-3 (kW)		 	 	 
					IP66	IP66	IP66
					Bestellnummer	Bestellnummer	Bestellnummer

41300
– 3-polig
– ohne Hilfskontakte



mit Modularachsverlängerung:

→ Verlängerungsbauteile siehe Seite 145!

20	5,5	3,7	36 x 36	H216-41300-234N4	H216-41300-234M4	H216-41300-234V4
20	5,5	3,7	48 x 48	H216-41300-238N4	H216-41300-238M4	H216-41300-238V4
25	7,5	5,5	36 x 36	H220-41300-234N4	H220-41300-234M4	H220-41300-234V4
25	7,5	5,5	48 x 48	H220-41300-238N4	H220-41300-238M4	H220-41300-238V4
32	11	7,5	36 x 36	H226-41300-234N4	H226-41300-234M4	H226-41300-234V4
32	11	7,5	48 x 48	H226-41300-238N4	H226-41300-238M4	H226-41300-238V4
40	15	11	36 x 36	H233-41300-234N4	H233-41300-234M4	H233-41300-234V4
40	15	11	36 x 36	B240-41300-234N4*	B240-41300-234M4*	B240-41300-234V4*
40	15	11	48 x 48	H233-41300-238N4	H233-41300-238M4	H233-41300-238V4
40	15	11	48 x 48	B240-41300-238N4*	B240-41300-238M4*	B240-41300-238V4*
50	18,5	15	36 x 36	B250-41300-234N4	B250-41300-234M4	B250-41300-234V4
50	18,5	15	48 x 48	B250-41300-238N4	B250-41300-238M4	B250-41300-238V4
63	22	18,5	36 x 36	B263-41300-234N4	B263-41300-234M4	B263-41300-234V4
63	22	18,5	48 x 48	B263-41300-238N4	B263-41300-238M4	B263-41300-238V4
63	22	18,5	48 x 48	H406-41300-234N4*	H406-41300-234M4*	H406-41300-234V4*
80	30	22	48 x 48	H408-41300-234N4	H408-41300-234M4	H408-41300-234V4
100	37	30	48 x 48	H410-41300-234N4	H410-41300-234M4	H410-41300-234V4
125	45	37	48 x 48	H412-41300-234N4	H412-41300-234M4	H412-41300-234V4

mit Metallachsverlängerung:

→ Zugehörige Metallachse getrennt bestellen, siehe Seite 146!

20	5,5	3,7	36 x 36	H216-41300-483N4	H216-41300-483M4	H216-41300-483V4
20	5,5	3,7	48 x 48	H216-41300-484N4	H216-41300-484M4	H216-41300-484V4
20	5,5	3,7	Ø 22,5	H216-41300-281N4	H216-41300-281M4	H216-41300-281V4
25	7,5	5,5	36 x 36	H220-41300-483N4	H220-41300-483M4	H220-41300-483V4
25	7,5	5,5	48 x 48	H220-41300-484N4	H220-41300-484M4	H220-41300-484V4
25	7,5	5,5	Ø 22,5	H220-41300-281N4	H220-41300-281M4	H220-41300-281V4
32	11	7,5	36 x 36	H226-41300-483N4	H226-41300-483M4	H226-41300-483V4
32	11	7,5	48 x 48	H226-41300-484N4	H226-41300-484M4	H226-41300-484V4
32	11	7,5	Ø 22,5	H226-41300-281N4	H226-41300-281M4	H226-41300-281V4
40	15	11	36 x 36	H233-41300-483N4	H233-41300-483M4	H233-41300-483V4
40	15	11	36 x 36	B240-41300-483N4*	B240-41300-483M4*	B240-41300-483V4*
40	15	11	48 x 48	H233-41300-484N4	H233-41300-484M4	H233-41300-484V4
40	15	11	48 x 48	B240-41300-484N4*	B240-41300-484M4*	B240-41300-484V4*
40	15	11	Ø 22,5	H233-41300-281N4	H233-41300-281M4	H233-41300-281V4
40	15	11	Ø 22,5	B240-41300-281N4*	B240-41300-281M4*	B240-41300-281V4*
50	18,5	15	36 x 36	B250-41300-483N4	B250-41300-483M4	B250-41300-483V4
50	18,5	15	48 x 48	B250-41300-484N4	B250-41300-484M4	B250-41300-484V4
50	18,5	15	Ø 22,5	B250-41300-281N4	B250-41300-281M4	B250-41300-281V4
63	22	18,5	36 x 36	B263-41300-483N4	B263-41300-483M4	B263-41300-483V4
63	22	18,5	48 x 48	B263-41300-484N4	B263-41300-484M4	B263-41300-484V4
63	22	18,5	48 x 48	H406-41300-483N4*	H406-41300-483M4*	H406-41300-483V4*
63	22	18,5	Ø 22,5	B263-41300-281N4	B263-41300-281M4	B263-41300-281V4
63	22	18,5	Ø 22,5	H406-41300-281N4*	H406-41300-281M4*	H406-41300-281V4*
80	30	22	48 x 48	H408-41300-483N4	H408-41300-483M4	H408-41300-483V4
80	30	22	Ø 22,5	H408-41300-281N4	H408-41300-281M4	H408-41300-281V4
100	37	30	48 x 48	H410-41300-483N4	H410-41300-483M4	H410-41300-483V4
100	37	30	Ø 22,5	H410-41300-281N4	H410-41300-281M4	H410-41300-281V4
125	45	37	48 x 48	H412-41300-483N4	H412-41300-483M4	H412-41300-483V4
125	45	37	Ø 22,5	H412-41300-281N4	H412-41300-281M4	H412-41300-281V4

* größerer Anschlussquerschnitt, s. Seite 154

Weitere Schaltprogramme ab Seite 132.

Schaltprogramm	Bemessungsdaten (IEC 60947) Betriebsstrom I_e Betriebsleistung (bei 380–440 V)			Befestigungsmaß (frontseitig) (mm)	Vorhängeschlossperre N-Griff gelb/rot	Vorhängeschlossperre M-Griff gelb/rot	Griffverriegelung V-Griff gelb/rot
	AC-21A (A)	AC-23A (kW)	AC-3 (kW)				
					IP66	IP66	IP66
					Bestellnummer	Bestellnummer	Bestellnummer

41400

- 4-polig
- ohne Hilfskontakte
- Neutralleiter voreilend

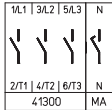

mit Modularachsverlängerung:

→ Verlängerungsbauteile siehe Seite 145!

20	5,5	3,7	36 x 36	H216-41400-234N4	H216-41400-234M4	H216-41400-234V4
20	5,5	3,7	48 x 48	H216-41400-238N4	H216-41400-238M4	H216-41400-238V4
25	7,5	5,5	36 x 36	H220-41400-234N4	H220-41400-234M4	H220-41400-234V4
25	7,5	5,5	48 x 48	H220-41400-238N4	H220-41400-238M4	H220-41400-238V4
32	11	7,5	36 x 36	H226-41400-234N4	H226-41400-234M4	H226-41400-234V4
32	11	7,5	48 x 48	H226-41400-238N4	H226-41400-238M4	H226-41400-238V4
40	15	11	36 x 36	H233-41400-234N4	H233-41400-234M4	H233-41400-234V4
40	15	11	36 x 36	B240-41400-234N4*	B240-41400-234M4*	B240-41400-234V4*
40	15	11	48 x 48	H233-41400-238N4	H233-41400-238M4	H233-41400-238V4
40	15	11	48 x 48	B240-41400-238N4*	B240-41400-238M4*	B240-41400-238V4*
50	18,5	15	36 x 36	B250-41400-234N4	B250-41400-234M4	B250-41400-234V4
50	18,5	15	48 x 48	B250-41400-238N4	B250-41400-238M4	B250-41400-238V4
63	22	18,5	36 x 36	B263-41400-234N4	B263-41400-234M4	B263-41400-234V4
63	22	18,5	48 x 48	B263-41400-238N4	B263-41400-238M4	B263-41400-238V4
63	22	18,5	48 x 48	H406-41400-234N4*	H406-41400-234M4*	H406-41400-234V4*
80	30	22	48 x 48	H408-41400-234N4	H408-41400-234M4	H408-41400-234V4
100	37	30	48 x 48	H410-41400-234N4	H410-41400-234M4	H410-41400-234V4
125	45	37	48 x 48	H412-41400-234N4	H412-41400-234M4	H412-41400-234V4

mit Metallachsverlängerung:

→ Zugehörige Metallachse getrennt bestellen, siehe Seite 146!







20	5,5	3,7	36 x 36	H216-41400-483N4	H216-41400-483M4	H216-41400-483V4
20	5,5	3,7	48 x 48	H216-41400-484N4	H216-41400-484M4	H216-41400-484V4
20	5,5	3,7	Ø 22,5	H216-41400-281N4	H216-41400-281M4	H216-41400-281V4
25	7,5	5,5	36 x 36	H220-41400-483N4	H220-41400-483M4	H220-41400-483V4
25	7,5	5,5	48 x 48	H220-41400-484N4	H220-41400-484M4	H220-41400-484V4
25	7,5	5,5	Ø 22,5	H220-41400-281N4	H220-41400-281M4	H220-41400-281V4
32	11	7,5	36 x 36	H226-41400-483N4	H226-41400-483M4	H226-41400-483V4
32	11	7,5	48 x 48	H226-41400-484N4	H226-41400-484M4	H226-41400-484V4
32	11	7,5	Ø 22,5	H226-41400-281N4	H226-41400-281M4	H226-41400-281V4
40	15	11	36 x 36	H233-41400-483N4	H233-41400-483M4	H233-41400-483V4
40	15	11	36 x 36	B240-41400-483N4*	B240-41400-483M4*	B240-41400-483V4*
40	15	11	48 x 48	H233-41400-484N4	H233-41400-484M4	H233-41400-484V4
40	15	11	48 x 48	B240-41400-484N4*	B240-41400-484M4*	B240-41400-484V4*
40	15	11	Ø 22,5	H233-41400-281N4	H233-41400-281M4	H233-41400-281V4
40	15	11	Ø 22,5	B240-41400-281N4*	B240-41400-281M4*	B240-41400-281V4*
50	18,5	15	36 x 36	B250-41400-483N4	B250-41400-483M4	B250-41400-483V4
50	18,5	15	48 x 48	B250-41400-484N4	B250-41400-484M4	B250-41400-484V4
50	18,5	15	Ø 22,5	B250-41400-281N4	B250-41400-281M4	B250-41400-281V4
63	22	18,5	36 x 36	B263-41400-483N4	B263-41400-483M4	B263-41400-483V4
63	22	18,5	48 x 48	B263-41400-484N4	B263-41400-484M4	B263-41400-484V4
63	22	18,5	48 x 48	H406-41400-483N4*	H406-41400-483M4*	H406-41400-483V4*
63	22	18,5	Ø 22,5	B263-41400-281N4	B263-41400-281M4	B263-41400-281V4
63	22	18,5	Ø 22,5	H406-41400-281N4*	H406-41400-281M4*	H406-41400-281V4*
80	30	22	48 x 48	H408-41400-483N4	H408-41400-483M4	H408-41400-483V4
80	30	22	Ø 22,5	H408-41400-281N4	H408-41400-281M4	H408-41400-281V4
100	37	30	48 x 48	H410-41400-483N4	H410-41400-483M4	H410-41400-483V4
100	37	30	Ø 22,5	H410-41400-281N4	H410-41400-281M4	H410-41400-281V4
125	45	37	48 x 48	H412-41400-483N4	H412-41400-483M4	H412-41400-483V4
125	45	37	Ø 22,5	H412-41400-281N4	H412-41400-281M4	H412-41400-281V4

* größerer Anschlussquerschnitt, s. Seite 154

Weitere Schaltprogramme ab Seite 132.

Lasttrennschalter

Haupt-/Notausschalter Bodeneinbau Schnappbefestigung mit Türverriegelung

Schaltprogramm	Bemessungsdaten (IEC 60947) Betriebsstrom I _e Betriebsleistung (bei 380–440 V)			Befestigungsmaß (frontseitig) (mm)	Vorhängeschlossperre N-Griff gelb/rot	Vorhängeschlossperre M-Griff gelb/rot	Griffverriegelung V-Griff gelb/rot
	AC-21A (A)	AC-23A (kW)	AC-3 (kW)		  IP66	  IP66	  IP66
					Bestellnummer	Bestellnummer	Bestellnummer

41600
– 6-polig
– ohne Hilfskontakte

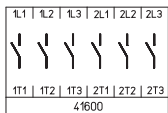

mit Modularachsverlängerung:

→ Verlängerungsbauteile siehe Seite 145!

20	5,5	3,7	36 x 36	H216-41600-234N4	H216-41600-234M4	–
20	5,5	3,7	48 x 48	H216-41600-238N4	H216-41600-238M4	H216-41600-238V4
25	7,5	5,5	36 x 36	H220-41600-234N4	H220-41600-234M4	–
25	7,5	5,5	48 x 48	H220-41600-238N4	H220-41600-238M4	H220-41600-238V4
32	11	7,5	36 x 36	H226-41600-234N4	H226-41600-234M4	–
32	11	7,5	48 x 48	H226-41600-238N4	H226-41600-238M4	H226-41600-238V4
40	15	11	36 x 36	H233-41600-234N4	H233-41600-234M4	–
40	15	11	36 x 36	B240-41600-234N4*	B240-41600-234M4*	–
40	15	11	48 x 48	H233-41600-238N4	H233-41600-238M4	H233-41600-238V4
40	15	11	48 x 48	B240-41600-238N4*	B240-41600-238M4*	B240-41600-238V4*
50	18,5	15	36 x 36	B250-41600-234N4	B250-41600-234M4	–
50	18,5	15	48 x 48	B250-41600-238N4	B250-41600-238M4	B250-41600-238V4
63	22	18,5	36 x 36	B263-41600-234N4	B263-41600-234M4	–
63	22	18,5	48 x 48	B263-41600-238N4	B263-41600-238M4	B263-41600-238V4
63	22	18,5	48 x 48	H406-41600-234N4*	H406-41600-234M4*	H406-41600-234V4*
80	30	22	48 x 48	H408-41600-234N4	H408-41600-234M4	H408-41600-234V4
100	37	30	48 x 48	H410-41600-234N4	H410-41600-234M4	H410-41600-234V4
125	45	37	48 x 48	H412-41600-234N4	H412-41600-234M4	H412-41600-234V4

mit Metallachsverlängerung:

→ Zugehörige Metallachse getrennt bestellen, siehe Seite 146!

20	5,5	3,7	36 x 36	H216-41600-483N4	H216-41600-483M4	–
20	5,5	3,7	48 x 48	H216-41600-484N4	H216-41600-484M4	H216-41600-484V4
20	5,5	3,7	Ø 22,5	H216-41600-281N4	H216-41600-281M4	–
25	7,5	5,5	36 x 36	H220-41600-483N4	H220-41600-483M4	–
25	7,5	5,5	48 x 48	H220-41600-484N4	H220-41600-484M4	H220-41600-484V4
25	7,5	5,5	Ø 22,5	H220-41600-281N4	H220-41600-281M4	–
32	11	7,5	36 x 36	H226-41600-483N4	H226-41600-483M4	–
32	11	7,5	48 x 48	H226-41600-484N4	H226-41600-484M4	H226-41600-484V4
32	11	7,5	Ø 22,5	H226-41600-281N4	H226-41600-281M4	–
40	15	11	36 x 36	H233-41600-483N4	H233-41600-483M4	–
40	15	11	36 x 36	B240-41600-483N4*	B240-41600-483M4*	–
40	15	11	48 x 48	H233-41600-484N4	H233-41600-484M4	H233-41600-484V4
40	15	11	48 x 48	B240-41600-484N4*	B240-41600-484M4*	B240-41600-484V4*
40	15	11	Ø 22,5	H233-41600-281N4	H233-41600-281M4	–
40	15	11	Ø 22,5	B240-41600-281N4*	B240-41600-281M4*	–
50	18,5	15	36 x 36	B250-41600-483N4	B250-41600-483M4	–
50	18,5	15	48 x 48	B250-41600-484N4	B250-41600-484M4	B250-41600-484V4
50	18,5	15	Ø 22,5	B250-41600-281N4	B250-41600-281M4	–
63	22	18,5	36 x 36	B263-41600-483N4	B263-41600-483M4	–
63	22	18,5	48 x 48	B263-41600-484N4	B263-41600-484M4	B263-41600-484V4
63	22	18,5	48 x 48	H406-41600-483N4*	H406-41600-483M4*	H406-41600-483V4*
63	22	18,5	Ø 22,5	B263-41600-281N4	B263-41600-281M4	–
63	22	18,5	Ø 22,5	H406-41600-281N4*	H406-41600-281M4*	H406-41600-281V4
80	30	22	48 x 48	H408-41600-483N4	H408-41600-483M4	H408-41600-483V4
80	30	22	Ø 22,5	H408-41600-281N4	H408-41600-281M4	H408-41600-281V4
100	37	30	48 x 48	H410-41600-483N4	H410-41600-483M4	H410-41600-483V4
100	37	30	Ø 22,5	H410-41600-281N4	H410-41600-281M4	H410-41600-281V4
125	45	37	48 x 48	H412-41600-483N4	H412-41600-483M4	H412-41600-483V4
125	45	37	Ø 22,5	H412-41600-281N4	H412-41600-281M4	H412-41600-281V4

* größerer Anschlussquerschnitt, s. Seite 154

Weitere Schaltprogramme ab Seite 132.

Schaltprogramm	Bemessungsdaten (IEC 60947) Betriebsstrom I _e Betriebsleistung (bei 380–440 V)			Befestigungsmaß (frontseitig) (mm)	Vorhängeschlossperre N-Griff gelb/rot	Vorhängeschlossperre M-Griff gelb/rot	Griffverriegelung V-Griff gelb/rot
	AC-21A (A)	AC-23A (kW)	AC-3 (kW)				
					IP66	IP66	IP66
					Bestellnummer	Bestellnummer	Bestellnummer

41800

- 8-polig
- ohne Hilfskontakte
- 2 Neutralleiter voreilend

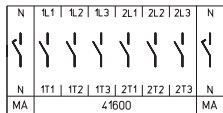

mit Modularachsverlängerung:

→ Verlängerungsbauteile siehe Seite 145!

20	25	32	40	50	63	80	100	125
5,5	7,5	11	15	18,5	22	30	37	45
3,7	5,5	7,5	11	15	18,5	22	30	37
36 × 36	36 × 36	36 × 36	36 × 36	36 × 36	36 × 36	48 × 48	48 × 48	48 × 48
H216-41800-234N4	H220-41800-234N4	H226-41800-234N4	H233-41800-234N4	B250-41800-234N4	B263-41800-234N4	H406-41800-234N4*	H410-41800-234N4	H412-41800-234N4
H216-41800-234M4	H220-41800-234M4	H226-41800-234M4	H233-41800-234M4	B250-41800-238M4	B263-41800-238M4	H406-41800-234M4*	H410-41800-234M4	H412-41800-234M4
–	–	–	–	–	–	H406-41800-234V4*	H410-41800-234V4	H412-41800-234V4
H216-41800-238N4	H220-41800-238N4	H226-41800-238N4	H233-41800-238N4	B250-41800-238N4	B263-41800-238N4	H406-41800-238N4*	H410-41800-238N4	H412-41800-238N4
H216-41800-238M4	H220-41800-238M4	H226-41800-238M4	H233-41800-238M4	B250-41800-238M4	B263-41800-238M4	H406-41800-238M4*	H410-41800-238M4	H412-41800-238M4
–	–	–	–	–	–	H406-41800-238V4*	H410-41800-238V4	H412-41800-238V4
H216-41800-238V4	H220-41800-238V4	H226-41800-238V4	H233-41800-238V4	B250-41800-238V4	B263-41800-238V4	H406-41800-238V4*	H410-41800-238V4	H412-41800-238V4

mit Metallachsverlängerung:

→ Zugehörige Metallachse getrennt bestellen, siehe Seite 146!

20	25	32	40	50	63	80	100	125
5,5	7,5	11	15	18,5	22	30	37	45
3,7	5,5	7,5	11	15	18,5	22	30	37
36 × 36	36 × 36	36 × 36	36 × 36	36 × 36	36 × 36	48 × 48	48 × 48	48 × 48
H216-41800-483N4	H220-41800-483N4	H226-41800-483N4	H233-41800-483N4	B250-41800-483N4	B263-41800-483N4	H406-41800-483N4*	H410-41800-483N4	H412-41800-483N4
H216-41800-483M4	H220-41800-483M4	H226-41800-483M4	H233-41800-483M4	B250-41800-483M4	B263-41800-483M4	H406-41800-483M4*	H410-41800-483M4	H412-41800-483M4
–	–	–	–	–	–	H406-41800-483V4*	H410-41800-483V4	H412-41800-483V4
H216-41800-484N4	H220-41800-484N4	H226-41800-484N4	H233-41800-484N4	B250-41800-484N4	B263-41800-484N4	H406-41800-484N4*	H410-41800-484N4	H412-41800-484N4
H216-41800-484M4	H220-41800-484M4	H226-41800-484M4	H233-41800-484M4	B250-41800-484M4	B263-41800-484M4	H406-41800-484M4*	H410-41800-484M4	H412-41800-484M4
–	–	–	–	–	–	H406-41800-484V4*	H410-41800-484V4	H412-41800-484V4
H216-41800-281N4	H220-41800-281N4	H226-41800-281N4	H233-41800-281N4	B250-41800-281N4	B263-41800-281N4	H406-41800-281N4*	H410-41800-281N4	H412-41800-281N4
H216-41800-281M4	H220-41800-281M4	H226-41800-281M4	H233-41800-281M4	B250-41800-281M4	B263-41800-281M4	H406-41800-281M4*	H410-41800-281M4	H412-41800-281M4
–	–	–	–	–	–	H406-41800-281V4*	H410-41800-281V4	H412-41800-281V4
H216-41800-484V4	H220-41800-484V4	H226-41800-484V4	H233-41800-484V4	B250-41800-484V4	B263-41800-484V4	H406-41800-484V4*	H410-41800-484V4	H412-41800-484V4

* größerer Anschlussquerschnitt, s. Seite 154

Weitere Schaltprogramme ab Seite 132.

Lasttrennschalter

Haupt-/Notausschalter **Bodeneinbau** Schnappbefestigung mit Türverriegelung

Abmessungen in mm:

Türverriegelung mit **Modularachsverlängerung**: Vierlochbefestigung (frontseitig)

Aufbau der Bestellnummer		
Typ	Schaltprogramm	Bauform
H233	41400	234N4
Best.-Nr. H233-41400-234N4		

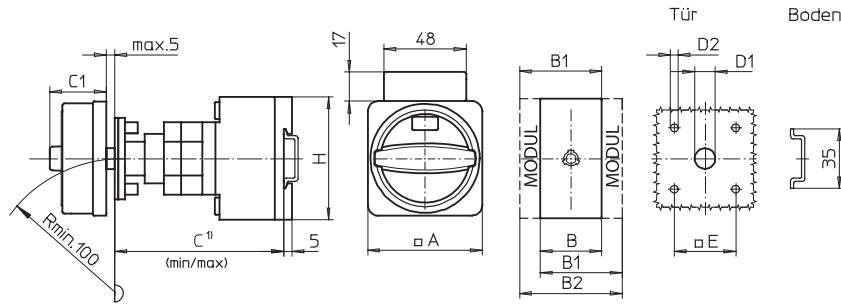

¹⁾ Einbaumaß: Innenseite Tür bis Oberkante Tragschiene, Abmessungen mit Verlängerung siehe Seite 145.

Schaltprogramme 3- und 4-polig

Typen H216 / H220 / H226 / H233:

Bauform	A	B	B1	B2	C _{min}	C _{max}	C1	D1	D2	E	H
234M4	67	36	48	60	92	107	38	15	4,5	36	70
234N4	67	36	48	60	92	107	33	15	4,5	36	70
234V4	48	36	48	60	92	107	32	12	4,5	36	70
238M4	67	36	48	60	92	107	38	15	5	48	70
238N4	67	36	48	60	92	107	33	15	5	48	70
238V4	64	36	48	60	92	107	39	15	5	48	70

Schaltprogramme 6- und 8-polig

Typen H216 / H220 / H226 / H233:

Bauform	A	B	B1	B2	C _{min}	C _{max}	C1	D1	D2	E	H
234M4	67	72	84	96	100	115	38	15	4,5	36	70
234N4	67	72	84	96	100	115	33	15	4,5	36	70
238M4	67	72	84	96	100	115	38	15	5	48	70
238N4	67	72	84	96	100	115	33	15	5	48	70
238V4	64	72	84	96	100	115	39	15	5	48	70

Typen B240 / B250 / B263:

Bauform	A	B	B1	B2	C _{min}	C _{max}	C1	D1	D2	E	H
234M4	67	50	69	88	92	107	38	15	4,5	36	72
234N4	67	50	69	88	92	107	33	15	4,5	36	72
234V4	48	50	69	88	92	107	32	12	4,5	36	72
238M4	67	50	69	88	92	107	38	15	5	48	72
238N4	67	50	69	88	92	107	33	15	5	48	72
238V4	64	50	69	88	92	107	39	15	5	48	72

Typen B240 / B250 / B263:

Bauform	A	B	B1	B2	C _{min}	C _{max}	C1	D1	D2	E	H
234M4	67	100	119	138	104	119	38	15	4,5	36	72
234N4	67	100	119	138	104	119	33	15	4,5	36	72
238M4	67	100	119	138	104	119	38	15	5	48	72
238N4	67	100	119	138	104	119	33	15	5	48	72
238V4	64	100	119	138	104	119	39	15	5	48	72

Typen H406 / H408 / H410 / H412:

Bauform	A	B	B1	B2	C _{min}	C _{max}	C1	D1	D2	E	H
234M4	88	70	89	108	102	117	50	15	5	48	80
234N4	88	70	89	108	102	117	45	15	5	48	80
234V4	64	70	89	108	102	117	40	15	5	48	80

Typen H406 / H408 / H410 / H412:

Bauform	A	B	B1	B2	C _{min}	C _{max}	C1	D1	D2	E	H
234M4	88	140	159	178	115	130	50	15	5	48	80
234N4	88	140	159	178	115	130	45	15	5	48	80
234V4	64	140	159	178	115	130	40	15	5	48	80

Abmessungen in mm:

Türverriegelung mit **Metallachsverlängerung**: Vierlochbefestigung (frontseitig)

Aufbau der Bestellnummer		
Typ	Schaltprogramm	Bauform
H406	41800	483N4
Best.-Nr. H406-41800-483N4		

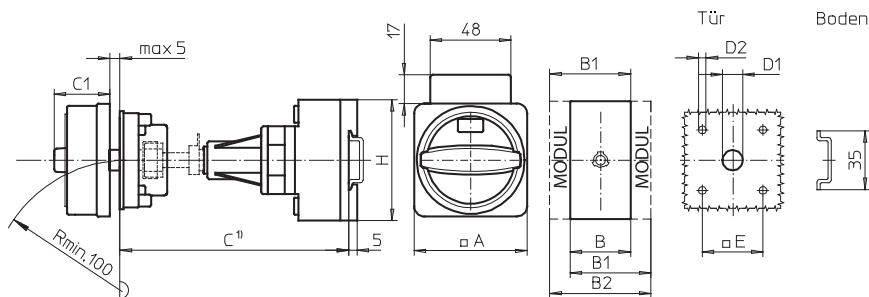

¹⁾ Einbaumaß: Innenseite Tür bis Oberkante Tragschiene, Abmessungen siehe Seite 146.

Schaltprogramme 3- und 4-polig

Typen H216 / H220 / H226 / H233:

Bauform	A	B	B1	B2	C1	D1	D2	E	H
483M4	67	36	48	60	38	15	4,5	36	70
483N4	67	36	48	60	33	15	4,5	36	70
483V4	48	36	48	60	32	15	4,5	36	70
484M4	67	36	48	60	38	15	5	48	70
484N4	67	36	48	60	33	15	5	48	70
484V4	64	36	48	60	39	15	5	48	70

Typen B240 / B250 / B263:

Bauform	A	B	B1	B2	C1	D1	D2	E	H
483M4	67	50	69	88	38	15	4,5	36	72
483N4	67	50	69	88	33	15	4,5	36	72
483V4	48	50	69	88	32	15	4,5	36	72
484M4	67	50	69	88	38	15	5	48	72
484N4	67	50	69	88	33	15	5	48	72
484V4	64	50	69	88	39	15	5	48	72

Typen H406 / H408 / H410 / H412:

Bauform	A	B	B1	B2	C1	D1	D2	E	H
483M4	88	70	89	108	50	15	5	48	80
483N4	88	70	89	108	45	15	5	48	80
483V4	64	70	89	108	40	15	5	48	80

Schaltprogramme 6- und 8-polig

Typen H216 / H220 / H226 / H233:

Bauform	A	B	B1	B2	C1	D1	D2	E	H
483M4	67	72	84	96	38	15	4,5	36	70
483N4	67	72	84	96	33	15	4,5	36	70
484M4	67	72	84	96	38	15	5	48	70
484N4	67	72	84	96	33	15	5	48	70
484V4	64	72	84	96	39	15	5	48	70

Typen B240 / B250 / B263:

Bauform	A	B	B1	B2	C1	D1	D2	E	H
483M4	67	100	119	138	38	15	4,5	36	72
483N4	67	100	119	138	33	15	4,5	36	72
484M4	67	100	119	138	38	15	5	48	72
484N4	67	100	119	138	33	15	5	48	72
484V4	64	100	119	138	39	15	5	48	72

Typen H406 / H408 / H410 / H412:

Bauform	A	B	B1	B2	C1	D1	D2	E	H
483M4	88	140	159	178	50	15	5	48	80
483N4	88	140	159	178	45	15	5	48	80
483V4	64	140	159	178	40	15	5	48	80

Lasttrennschalter

Haupt-/Notausschalter **Bodeneinbau** Schnappbefestigung mit Türverriegelung

Abmessungen in mm:

Türverriegelung mit **Metallachsverlängerung**: Zentralbefestigung (frontseitig)

Aufbau der Bestellnummer		
Typ	Schaltprogramm	Bauform
H233	41400	281N4
Best.-Nr. H233-41400-281N4		

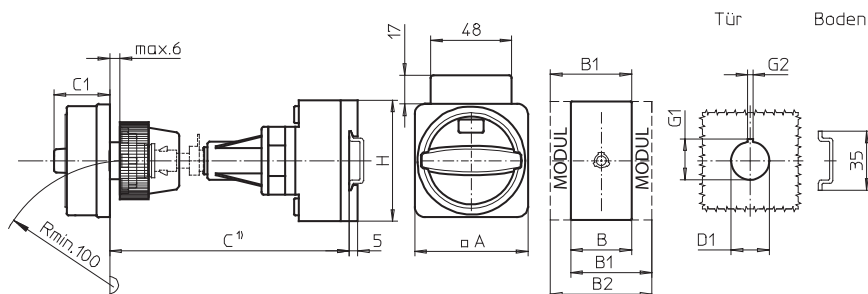

¹⁾ Einbaumaß: Außenseite Tür bis Oberkante Tragschiene, Abmessungen siehe Seite 146.

Schaltprogramme 3- und 4-polig

Typen H216 / H220 / H226 / H233:

Bauform	A	B	B1	B2	C1	D1	G1	G2	H
281M4	67	36	48	60	38	22,5	24,2	3,2	70
281N4	67	36	48	60	33	22,5	24,2	3,2	70
281V4	48	36	48	60	32	22,5	24,2	3,2	70

Typen B240 / B250 / B263:

Bauform	A	B	B1	B2	C1	D1	G1	G2	H
281M4	67	50	69	88	38	22,5	24,2	3,2	72
281N4	67	50	69	88	33	22,5	24,2	3,2	72
281V4	48	50	69	88	32	22,5	24,2	3,2	72

Typen H406 / H408 / H410 / H412:

Bauform	A	B	B1	B2	C1	D1	G1	G2	H
281M4	67	70	89	108	38	22,5	24,2	3,2	80
281N4	67	70	89	108	33	22,5	24,2	3,2	80
281V4	64	70	89	108	39	22,5	24,2	3,2	80

Schaltprogramme 6- und 8-polig

Typen H216 / H220 / H226 / H233:

Bauform	A	B	B1	B2	C1	D1	G1	G2	H
281M4	67	72	84	96	38	22,5	24,2	3,2	70
281N4	67	72	84	96	33	22,5	24,2	3,2	70

Typen B240 / B250 / B263:

Bauform	A	B	B1	B2	C1	D1	G1	G2	H
281M4	67	100	119	138	38	22,5	24,2	3,2	72
281N4	67	100	119	138	33	22,5	24,2	3,2	72

Typen H406 / H408 / H410 / H412:

Bauform	A	B	B1	B2	C1	D1	G1	G2	H
281M4	67	140	159	178	38	22,5	24,2	3,2	80
281N4	67	140	159	178	33	22,5	24,2	3,2	80
281V4	64	140	159	178	39	22,5	24,2	3,2	80

Haupt-/Notausschalter

- Bodeneinbauschalter mit Vierlochbefestigung
- Türverriegelung
- 3- bis 8-polig
- 160 A bis 315 A
- IP55



Schaltprogramm	Bemessungsdaten (IEC 60947) Betriebs- Betriebsleistung strom I _e (bei 380–440 V)			Befestigungsmaß (boden-/frontseitig) (mm)	Vorhängeschlossperre N-Griff gelb/rot	Vorhängeschlossperre M-Griff gelb/rot	Vorhängeschlossperre H-Griff gelb/rot
	AC-21A (A)	AC-23A (kW)	AC-3 (kW)				
					IP55	IP55	IP55
					Bestellnummer	Bestellnummer	Bestellnummer
41300 – 3-polig – ohne Hilfskontakte	160	75	45	68 × 68 / 68 × 68	K616-41300-034N4	K616-41300-034M4	K616-41300-034H4
	315	132	55	104 × 104 / 104 × 104	–	–	K830-41300-034H4

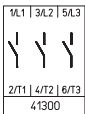

41400 – 4-polig – ohne Hilfskontakte – Neutralleiter voreilend	160	75	45	68 × 68 / 68 × 68	K616-41400-034N4	K616-41400-034M4	K616-41400-034H4
	315	132	55	104 × 104 / 104 × 104	–	–	K830-41400-034H4

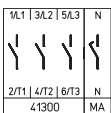

41600 – 6-polig – ohne Hilfskontakte	160	75	45	68 × 68 / 68 × 68	K616-41600-034N4	K616-41600-034M4	K616-41600-034H4
	315	132	55	104 × 104 / 104 × 104	–	–	K830-41600-034H4

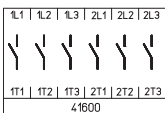

41800 – 8-polig – ohne Hilfskontakte – 2 Neutralleiter voreilend	160	75	45	68 × 68 / 68 × 68	K616-41800-034N4	K616-41800-034M4	K616-41800-034H4
	315	132	55	104 × 104 / 104 × 104	–	–	K830-41800-034H4

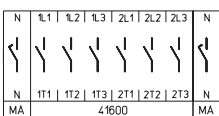

Lasttrennschalter

Haupt-/Notausschalter Bodeneinbau Vierlochbefestigung mit Türverriegelung

Abmessungen in mm:

Aufbau der Bestellnummer

Typ	Schaltprogramm	Bauform
K616	41300	034N4
Best.-Nr.	K616-41300-034N4	

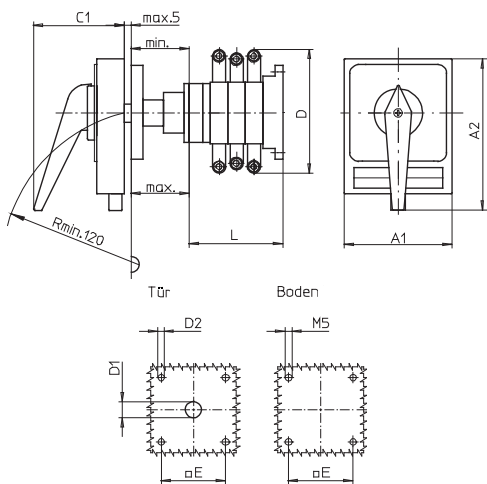
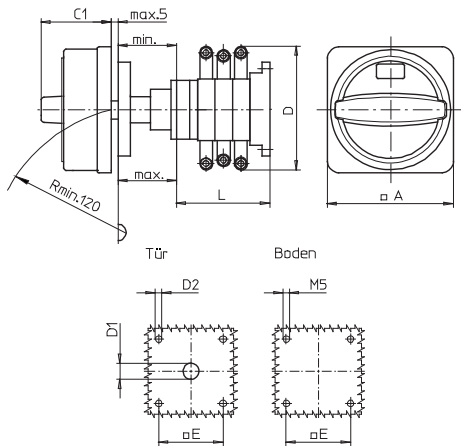

Typ K616:

Bauform	Schaltprogramm	A	C1	D*	D1	D2	E	min	max	L
034M4	41300	88	50	150	15	5,5	68	48	60	104
034M4	41400	88	50	150	15	5,5	68	48	60	104
034M4	41600	88	50	150	15	5,5	68	48	60	136
034M4	41800	88	50	150	15	5,5	68	48	60	168
034N4	41300	88	45	150	15	5,5	68	48	60	104
034N4	41400	88	45	150	15	5,5	68	48	60	104
034N4	41600	88	45	150	15	5,5	68	48	60	136
034N4	41800	88	45	150	15	5,5	68	48	60	168

Typ K616:

Bauform	Schaltprogramm	A1	A2	C1	D*	D1	D2	E	min	max	L
034H4	41300	98	142	83	150	15	5,5	68	48	60	104
034H4	41400	98	142	83	150	15	5,5	68	48	60	104
034H4	41600	98	142	83	150	15	5,5	68	48	60	136
034H4	41800	98	142	83	150	15	5,5	68	48	60	168

Typ K830:

Bauform	Schaltprogramm	A1	A2	C1	D*	D1	D2	E	min	max	L
034H4	41300	130	176	93	210	20	5,5	104	75	102	125
034H4	41400	130	176	93	210	20	5,5	104	75	102	125
034H4	41600	130	176	93	210	20	5,5	104	75	102	161
034H4	41800	130	176	93	210	20	5,5	104	75	102	197

* einschließlich Anschlusswinkel



Weitere Schaltprogramme und zugehörige Abmessungen für Typen K auf Anfrage.

Haupt-/Notausschalter

- Gekapselte Schalter mit Isolierstoffgehäuse (Polycarbonat)
- Deckelverriegelung in EIN-Stellung
- 3- bis 8-polig
- 20 A bis 315 A
- IP66







Schaltprogramm	Bemessungsdaten (IEC 60947) Betriebsstrom I_e Betriebsleistung (bei 380–440 V)			Gehäuse- abmessungen (H × B × T) (mm)	Vorhängeschlosssperre N-Griff gelb/rot	Vorhängeschlosssperre M-Griff gelb/rot	Griffverriegelung V-Griff gelb/rot
	AC-21A (A)	AC-23A (kW)	AC-3 (kW)		  IP66	  IP66	  IP66
					Bestellnummer	Bestellnummer	Bestellnummer
41300 – 3-polig – ohne Hilfskontakte 	20	5,5	3,7	125 × 100 × 85	H216-41300-700N4	H216-41300-700M4	H216-41300-700V4
	20	5,5	3,7	175 × 115 × 100	H216-41300-710N4	H216-41300-710M4	H216-41300-710V4
	20	5,5	3,7	250 × 160 × 120	H216-41300-730N4	H216-41300-730M4	H216-41300-730V4
	25	7,5	5,5	125 × 100 × 85	H220-41300-700N4	H220-41300-700M4	H220-41300-700V4
	25	7,5	5,5	175 × 115 × 100	H220-41300-710N4	H220-41300-710M4	H220-41300-710V4
	25	7,5	5,5	250 × 160 × 120	H220-41300-730N4	H220-41300-730M4	H220-41300-730V4
	32	11	7,5	125 × 100 × 85	H226-41300-700N4	H226-41300-700M4	H226-41300-700V4
	32	11	7,5	175 × 115 × 100	H226-41300-710N4	H226-41300-710M4	H226-41300-710V4
	32	11	7,5	250 × 160 × 120	H226-41300-730N4	H226-41300-730M4	H226-41300-730V4
	40	15	11	175 × 115 × 100	H233-41300-710N4	H233-41300-710M4	H233-41300-710V4
	40	15	11	175 × 115 × 100	B240-41300-710N4*¹	B240-41300-710M4*¹	B240-41300-710V4*¹
	40	15	11	250 × 160 × 120	H233-41300-730N4	H233-41300-730M4	H233-41300-730V4
	40	15	11	250 × 160 × 120	B240-41300-730N4*	B240-41300-730M4*	B240-41300-730V4*
	50	18,5	15	175 × 115 × 100	B250-41300-710N4¹	B250-41300-710M4¹	B250-41300-710V4¹
	50	18,5	15	250 × 160 × 120	B250-41300-730N4	B250-41300-730M4	B250-41300-730V4
	63	22	18,5	175 × 115 × 100	B263-41300-710N4¹	B263-41300-710M4¹	B263-41300-710V4¹
	63	22	18,5	250 × 160 × 120	B263-41300-730N4	B263-41300-730M4	B263-41300-730V4
	63	22	18,5	250 × 160 × 120	H406-41300-730N4*	H406-41300-730M4*	–
	63	22	18,5	280 × 190 × 130	H406-41300-770N4	H406-41300-770M4	H406-41300-770V4
	63	22	18,5	320 × 220 × 180	H406-41300-471N4	H406-41300-471M4	–
80	30	22	250 × 160 × 120	H408-41300-730N4	H408-41300-730M4	–	
80	30	22	280 × 190 × 130	H408-41300-770N4	H408-41300-770M4	H408-41300-770V4	
80	30	22	320 × 220 × 180	H408-41300-471N4	H408-41300-471M4	–	
100	37	30	250 × 160 × 120	H410-41300-730N4	H410-41300-730M4	–	
100	37	30	280 × 190 × 130	H410-41300-770N4	H410-41300-770M4	H410-41300-770V4	
100	37	30	320 × 220 × 180	H410-41300-471N4	H410-41300-471M4	–	
125	45	37	320 × 220 × 180	H412-41300-471N4	H412-41300-471M4	–	

* größerer Anschluss- querschnitt, s. Seite 154	Bemessungsdaten (IEC 60947) Betriebsstrom I_e Betriebsleistung (bei 380–440 V)			Gehäuse- abmessungen (H × B × T) (mm)	Vorhängeschlosssperre H-Griff gelb/rot
	AC-21A (A)	AC-23A (kW)	AC-3 (kW)		  IP66
¹ max. Anschlussquerschnitt 16 mm ² an N- und/oder PE-Gehäuseklemme					Bestellnummer
	160	75	45	440 × 320 × 180	K616-41300-077H4
	160	75	45	440 × 320 × 255	K616-41300-177H4
Weitere Schaltprogramme ab Seite 132.	315	132	55	640 × 320 × 255	K830-41300-077H4
	315	132	55	640 × 320 × 330	K830-41300-177H4

Lasttrennschalter

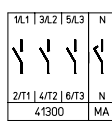
Haupt-/Notausschalter Gekapselte Schalter mit Isolierstoffgehäuse

Schaltprogramm	Bemessungsdaten (IEC 60947) Betriebsstrom I_e Betriebsleistung (bei 380–440 V)			Gehäuse- abmessungen (H × B × T) (mm)	Vorhängeschlossperre N-Griff gelb/rot 	Vorhängeschlossperre M-Griff gelb/rot 	Griffverriegelung V-Griff gelb/rot 
	AC-21A (A)	AC-23A (kW)	AC-3 (kW)		IP66	IP66	IP66
					Bestellnummer	Bestellnummer	Bestellnummer
41400 – 4-polig – ohne Hilfskontakte – Neutralleiter voreilend 	20	5,5	3,7	125 × 100 × 85	H216-41400-700N4	H216-41400-700M4	H216-41400-700V4
	20	5,5	3,7	175 × 115 × 100	H216-41400-710N4	H216-41400-710M4	H216-41400-710V4
	20	5,5	3,7	250 × 160 × 120	H216-41400-730N4	H216-41400-730M4	H216-41400-730V4
	25	7,5	5,5	125 × 100 × 85	H220-41400-700N4	H220-41400-700M4	H220-41400-700V4
	25	7,5	5,5	175 × 115 × 100	H220-41400-710N4	H220-41400-710M4	H220-41400-710V4
	25	7,5	5,5	250 × 160 × 120	H220-41400-730N4	H220-41400-730M4	H220-41400-730V4
	32	11	7,5	125 × 100 × 85	H226-41400-700N4	H226-41400-700M4	H226-41400-700V4
	32	11	7,5	175 × 115 × 100	H226-41400-710N4	H226-41400-710M4	H226-41400-710V4
	32	11	7,5	250 × 160 × 120	H226-41400-730N4	H226-41400-730M4	H226-41400-730V4
	40	15	11	175 × 115 × 100	H233-41400-710N4	H233-41400-710M4	H233-41400-710V4
	40	15	11	175 × 115 × 100	B240-41400-710N4*¹	B240-41400-710M4*¹	B240-41400-710V4*¹
	40	15	11	250 × 160 × 120	H233-41400-730N4	H233-41400-730M4	H233-41400-730V4
	40	15	11	250 × 160 × 120	B240-41400-730N4*	B240-41400-730M4*	B240-41400-730V4*
	50	18,5	15	175 × 115 × 100	B250-41400-710N4¹	B250-41400-710M4¹	B250-41400-710V4¹
	50	18,5	15	250 × 160 × 120	B250-41400-730N4	B250-41400-730M4	B250-41400-730V4
	63	22	18,5	175 × 115 × 100	B263-41400-710N4¹	B263-41400-710M4¹	B263-41400-710V4¹
	63	22	18,5	250 × 160 × 120	B263-41400-730N4	B263-41400-730M4	B263-41400-730V4
	63	22	18,5	250 × 160 × 120	H406-41400-730N4*	H406-41400-730M4*	–
	63	22	18,5	280 × 190 × 130	H406-41400-770N4	H406-41400-770M4	H406-41400-770V4
	63	22	18,5	320 × 220 × 180	H406-41400-471N4	H406-41400-471M4	–
	80	30	22	250 × 160 × 120	H408-41400-730N4	H408-41400-730M4	–
	80	30	22	280 × 190 × 130	H408-41400-770N4	H408-41400-770M4	H408-41400-770V4
	80	30	22	320 × 220 × 180	H408-41400-471N4	H408-41400-471M4	–
	100	37	30	250 × 160 × 120	H410-41400-730N4	H410-41400-730M4	–
	100	37	30	280 × 190 × 130	H410-41400-770N4	H410-41400-770M4	H410-41400-770V4
	100	37	30	320 × 220 × 180	H410-41400-471N4	H410-41400-471M4	–
	125	45	37	320 × 220 × 180	H412-41400-471N4	H412-41400-471M4	–

Bemessungsdaten (IEC 60947) Betriebsstrom I_e Betriebsleistung (bei 380–440 V)			Gehäuse- abmessungen (H × B × T) (mm)	Vorhängeschlossperre H-Griff gelb/rot 
AC-21A (A)	AC-23A (kW)	AC-3 (kW)		IP66
				Bestellnummer
160	75	45	440 × 320 × 180	K616-41400-077H4
160	75	45	440 × 320 × 255	K616-41400-177H4
315	132	55	640 × 320 × 255	K830-41400-077H4
315	132	55	640 × 320 × 330	K830-41400-177H4

* größerer Anschlussquerschnitt, siehe Seite 154



¹ max. Anschlussquerschnitt 16 mm² an N- und/oder PE-Gehäuseklemme

Weitere Schaltprogramme ab Seite 132.

Lasttrennschalter

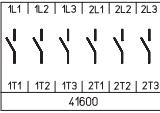

Haupt-/Notausschalter Gekapselte Schalter mit Isolierstoffgehäuse

Schaltprogramm	Bemessungsdaten (IEC 60947) Betriebsstrom I_e Betriebsleistung (bei 380–440 V)			Gehäuse- abmessungen (H × B × T) (mm)	Vorhängeschlossperre N-Griff gelb/rot  IP66	Vorhängeschlossperre M-Griff gelb/rot  IP66	Griffverriegelung V-Griff gelb/rot  IP66
	AC-21A (A)	AC-23A (kW)	AC-3 (kW)		Bestellnummer	Bestellnummer	Bestellnummer
41600 – 6-polig – ohne Hilfskontakte 	20	5,5	3,7	175 × 115 × 100	H216-41600-720N4	H216-41600-720M4	H216-41600-720V4
	20	5,5	3,7	250 × 160 × 120	H216-41600-733N4	H216-41600-733M4	H216-41600-733V4
	25	7,5	5,5	175 × 115 × 100	H220-41600-720N4	H220-41600-720M4	H220-41600-720V4
	25	7,5	5,5	250 × 160 × 120	H220-41600-733N4	H220-41600-733M4	H220-41600-733V4
	32	11	7,5	175 × 115 × 100	H226-41600-720N4	H226-41600-720M4	H226-41600-720V4
	32	11	7,5	250 × 160 × 120	H226-41600-733N4	H226-41600-733M4	H226-41600-733V4
	40	15	11	175 × 115 × 100	H233-41600-720N4	H233-41600-720M4	H233-41600-720V4
	40	15	11	250 × 160 × 120	H233-41600-733N4	H233-41600-733M4	H233-41600-733V4
	40	15	11	320 × 220 × 180	B240-41600-977N4	B240-41600-977M4	–
	50	18,5	15	320 × 220 × 180	B250-41600-977N4	B250-41600-977M4	–
	63	22	18,5	320 × 220 × 180	B263-41600-977N4	B263-41600-977M4	–
	63	22	18,5	320 × 220 × 180	H406-41600-977N4*	H406-41600-977M4*	–
	63	22	18,5	440 × 320 × 180	H406-41600-577N4	H406-41600-577M4	–
	80	30	22	320 × 220 × 180	H408-41600-977N4	H408-41600-977M4	–
	80	30	22	440 × 320 × 180	H408-41600-577N4	H408-41600-577M4	–
	100	37	30	320 × 220 × 180	H410-41600-977N4	H410-41600-977M4	–
	100	37	30	440 × 320 × 180	H410-41600-577N4	H410-41600-577M4	–
125	45	37	320 × 220 × 180	H412-41600-977N4	H412-41600-977M4	–	
125	45	37	440 × 320 × 180	H412-41600-577N4	H412-41600-577M4	–	



Bemessungsdaten (IEC 60947) Betriebsstrom I_e Betriebsleistung (bei 380–440 V)			Gehäuse- abmessungen (H × B × T) (mm)	Vorhängeschlossperre H-Griff gelb/rot  IP66
AC-21A (A)	AC-23A (kW)	AC-3 (kW)		Bestellnummer
160	75	45	440 × 320 × 255	K616-41600-177H4
315	132	55	640 × 320 × 330	K830-41600-177H4

* größerer Anschlussquerschnitt, siehe Seite 154

Weitere Schaltprogramme ab Seite 132.

Lasttrennschalter

Haupt-/Notausschalter Gekapselte Schalter mit Isolierstoffgehäuse

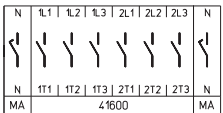
Schaltprogramm	Bemessungsdaten (IEC 60947) Betriebsstrom I_e Betriebsleistung (bei 380–440 V)			Gehäuse- abmessungen (H × B × T) (mm)	Vorhängeschlossperre N-Griff gelb/rot  OFF ON IP66	Vorhängeschlossperre M-Griff gelb/rot  ON OFF IP66	Griffverriegelung V-Griff gelb/rot  ON OFF IP66
	AC-21A (A)	AC-23A (kW)	AC-3 (kW)		Bestellnummer	Bestellnummer	Bestellnummer
41800 – 8-polig – ohne Hilfskontakte – 2 Neutralleiter voreilend 	20	5,5	3,7	250 × 160 × 120	H216-41800-733N4	H216-41800-733M4	H216-41800-733V4
	20	5,5	3,7	280 × 190 × 130	H216-41800-770N4	H216-41800-770M4	H216-41800-770V4
	25	7,5	5,5	250 × 160 × 120	H220-41800-733N4	H220-41800-733M4	H220-41800-733V4
	25	7,5	5,5	280 × 190 × 130	H220-41800-770N4	H220-41800-770M4	H220-41800-770V4
	32	11	7,5	250 × 160 × 120	H226-41800-733N4	H226-41800-733M4	H226-41800-733V4
	32	11	7,5	280 × 190 × 130	H226-41800-770N4	H226-41800-770M4	H226-41800-770V4
	40	15	11	250 × 160 × 120	H233-41800-733N4	H233-41800-733M4	H233-41800-733V4
	40	15	11	280 × 190 × 130	H233-41800-770N4	H233-41800-770M4	H233-41800-770V4
	40	15	11	280 × 190 × 130	B240-41800-770N4*¹	B240-41800-770M4*¹	B240-41800-770V4*¹
	40	15	11	320 × 220 × 180	B240-41800-977N4	B240-41800-977M4	–
	50	18,5	15	280 × 190 × 130	B250-41800-770N4¹	B250-41800-770M4¹	B250-41800-770V4¹
	50	18,5	15	320 × 220 × 180	B250-41800-977N4	B250-41800-977M4	–
	63	22	18,5	280 × 190 × 130	B263-41800-770N4¹	B263-41800-770M4¹	B263-41800-770V4¹
	63	22	18,5	320 × 220 × 180	B263-41800-977N4	B263-41800-977M4	–
	63	22	18,5	320 × 220 × 180	H406-41800-977N4*	H406-41800-977M4*	–
	63	22	18,5	440 × 320 × 180	H406-41800-577N4	H406-41800-577M4	–
	80	30	22	320 × 220 × 180	H408-41800-977N4	H408-41800-977M4	–
	80	30	22	440 × 320 × 180	H408-41800-577N4	H408-41800-577M4	–
	100	37	30	320 × 220 × 180	H410-41800-977N4	H410-41800-977M4	–
	100	37	30	440 × 320 × 180	H410-41800-577N4	H410-41800-577M4	–
125	45	37	320 × 220 × 180	H412-41800-977N4	H412-41800-977M4	–	
125	45	37	440 × 320 × 180	H412-41800-577N4	H412-41800-577M4	–	

Bemessungsdaten (IEC 60947) Betriebsstrom I_e Betriebsleistung (bei 380–440 V)			Gehäuse- abmessungen (H × B × T) (mm)	Vorhängeschlossperre H-Griff gelb/rot  ON OFF IP66
AC-21A (A)	AC-23A (kW)	AC-3 (kW)		Bestellnummer
160	75	45	440 × 320 × 255	K616-41800-177H4
315	132	55	640 × 320 × 330	K830-41800-177H4

* größerer Anschlussquerschnitt, siehe Seite 154

¹ max. Anschlussquerschnitt 16 mm² an N- und/oder PE-Gehäuseklemme

Weitere Schaltprogramme ab Seite 132.

Abmessungen in mm:

Aufbau der Bestellnummer

Typ	Schaltprogramm	Bauform
H216	41400	700M4
Best.-Nr.	H216-41400-700M4	

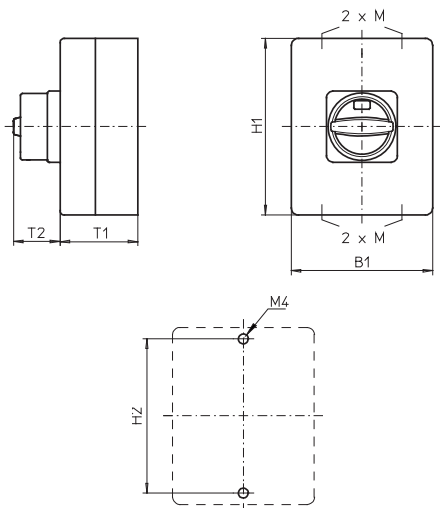

**Isolierstoffgehäuse 125 × 100 × 85 mm
und 175 × 115 × 100 mm:**

Typen H216 / H220 / H226 / H233 / B240 / B250 / B263:

Bauform	H1	B1	T1	T2	2×M	H2
700M4	125	100	85	38	20/25	115
700N4	125	100	85	33	20/25	115
700V4	125	100	85	32	20/25	115
710M4	175	115	100	38	20/25	165
710N4	175	115	100	33	20/25	165
710V4	175	115	100	39	20/25	165
720M4	175	115	100	38	20/25	165
720N4	175	115	100	33	20/25	165
720V4	175	115	100	39	20/25	165

Isolierstoffgehäuse 250 × 160 × 120 mm:

Typen H216 / H220 / H226 / H233:

Bauform	H1	B1	T1	T2	2×M	H2
730M4	250	160	120	38	32/40	235
730N4	250	160	120	33	32/40	235
730V4	250	160	120	39	32/40	235
733M4	250	160	120	38	32/40	235
733N4	250	160	120	33	32/40	235
733V4	250	160	120	39	32/40	235

Typen B240 / B250 / B263:

Bauform	H1	B1	T1	T2	2×M	H2
730M4	250	160	120	50	32/40	235
730N4	250	160	120	45	32/40	235
730V4	250	160	120	39	32/40	235

Typen H406 / H408 / H410 / H412:

Bauform	H1	B1	T1	T2	2×M	H2
730M4	250	160	120	50	32/40	235
730N4	250	160	120	45	32/40	235

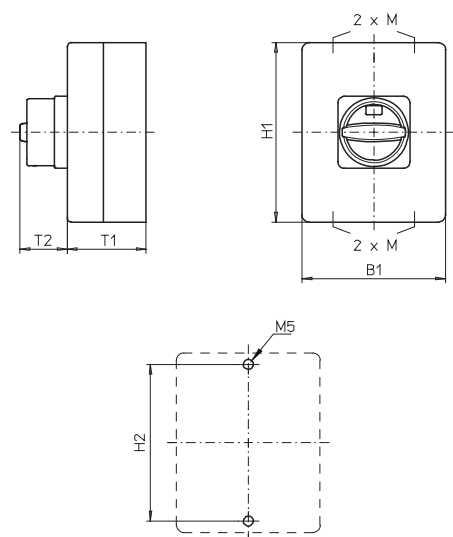

Lasttrennschalter

Haupt-/Notausschalter Gekapselte Schalter mit Isolierstoffgehäuse

Abmessungen in mm:

Aufbau der Bestellnummer		
Typ	Schaltprogramm	Bauform
H406	41300	770M4
Best.-Nr.	H406-41300-770M4	

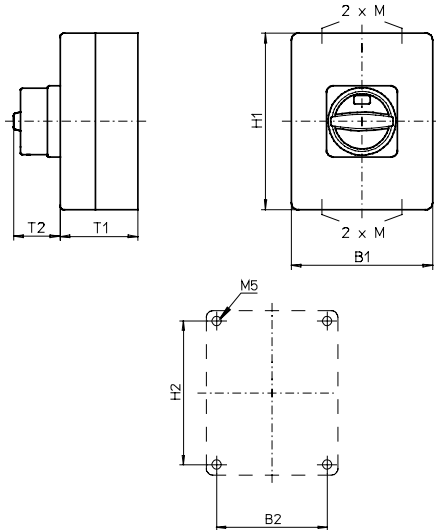

Isolierstoffgehäuse **280 × 190 × 130 mm**
und **320 × 220 × 180 mm**:

Typen H216 / H220 / H226 / H233 / B240 / B250 / B263 /
H406 / H408 / H410 / H412:

Bauform	H1	B1	T1	T2	2×M	H2	B2
770M4	280	190	130	50	40×1,5	254	164
770N4	280	190	130	45	40×1,5	254	164
770V4	280	190	130	39	40×1,5	254	164
471M4	320	220	180	50	- ¹	293	193
471N4	320	220	180	45	- ¹	293	193
977M4	320	220	180	50	- ¹	293	193
977N4	320	220	180	45	- ¹	293	193

¹ Flanschplatten ohne Vorprägungen

Isolierstoffgehäuse **440 × 320 × 180 mm /**
440 × 320 × 255 mm / 640 × 320 × 255 mm /
640 × 320 × 330 mm:

Typen H406 / H408 / H410 / H412:

Bauform	H1	B1	T1	T2	H2	B2
577M4	440	320	180	50	480	293
577N4	440	320	180	45	480	293

Typ K616:

Bauform	H1	B1	T1	T2	H2	B2
077H4	440	320	180	83	480	293
177H4	440	320	255	83	480	293

Typ K830:

Bauform	H1	B1	T1	T2	H2	B2
077H4	640	320	255	93	680	293
177H4	640	320	330	93	680	293

Weitere Schaltprogramme und zugehörige Abmessungen für Typen K auf Anfrage.

Flanschplatten ohne Vorprägungen

Zugehörige Befestigungslaschen sind im Lieferumfang enthalten.

Haupt-/Notausschalter

- Gekapselte Schalter mit Isolierstoffgehäuse (Polycarbonat)
- EMV-Anwendung, Verbindungssystem zur unterbrechungsfreien Durchführung abgeschirmter Kabel bestehend aus Schirmblech und 4 Schirmklammern \varnothing 12–16 mm
- Deckelverriegelung in EIN-Stellung
- 3- bis 6-polig
- 20 A bis 63 A
- IP66

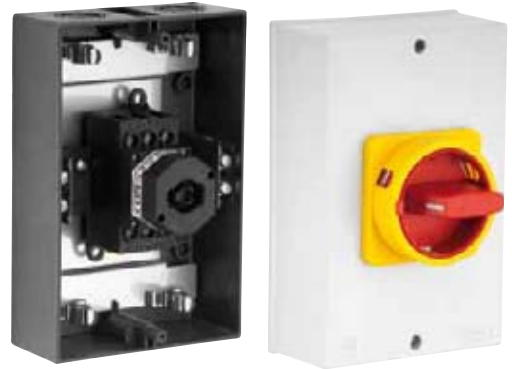

Schaltprogramm	Bemessungsdaten (IEC 60947) Betriebs- Betriebsleistung strom I_e (bei 380–440 V)			Gehäuse- abmessungen (H × B × T) (mm)	Vorhängeschlosssperre N-Griff gelb/rot	Vorhängeschlosssperre M-Griff gelb/rot	Griffverriegelung V-Griff gelb/rot
	AC-21A (A)	AC-23A (kW)	AC-3 (kW)				
41300 – 3-polig – ohne Hilfskontakte	20	5,5	3,7	175 × 115 × 100	IP66	IP66	IP66
	25	7,5	5,5	175 × 115 × 100	H216-41300-715N4	H216-41300-715M4	H216-41300-715V4
	32	11	7,5	175 × 115 × 100	H220-41300-715N4	H220-41300-715M4	H220-41300-715V4
	40	15	11	175 × 115 × 100	H226-41300-715N4	H226-41300-715M4	H226-41300-715V4
	40	15	11	175 × 115 × 100	H233-41300-715N4	H233-41300-715M4	H233-41300-715V4
	50	18,5	15	175 × 115 × 100	B240-41300-715N4*	B240-41300-715M4*	B240-41300-715V4*
	63	22	18,5	175 × 115 × 100	B250-41300-715N4	B250-41300-715M4	B250-41300-715V4
					B263-41300-715N4	B263-41300-715M4	B263-41300-715V4
41400 – 4-polig – ohne Hilfskontakte – Neutralleiter voreilend	20	5,5	3,7	175 × 115 × 100	H216-41400-715N4	H216-41400-715M4	H216-41400-715V4
	25	7,5	5,5	175 × 115 × 100	H220-41400-715N4	H220-41400-715M4	H220-41400-715V4
	32	11	7,5	175 × 115 × 100	H226-41400-715N4	H226-41400-715M4	H226-41400-715V4
	40	15	11	175 × 115 × 100	H233-41400-715N4	H233-41400-715M4	H233-41400-715V4
	40	15	11	175 × 115 × 100	B240-41400-715N4*	B240-41400-715M4*	B240-41400-715V4*
	50	18,5	15	175 × 115 × 100	B250-41400-715N4	B250-41400-715M4	B250-41400-715V4
	63	22	18,5	175 × 115 × 100	B263-41400-715N4	B263-41400-715M4	B263-41400-715V4
41600 – 6-polig – ohne Hilfskontakte	20	5,5	3,7	175 × 115 × 100	H216-41600-725N4	H216-41600-725M4	H216-41600-725V4
	25	7,5	5,5	175 × 115 × 100	H220-41600-725N4	H220-41600-725M4	H220-41600-725V4
	32	11	7,5	175 × 115 × 100	H226-41600-725N4	H226-41600-725M4	H226-41600-725V4
	40	15	11	175 × 115 × 100	H233-41600-725N4	H233-41600-725M4	H233-41600-725V4

* größerer Anschlussquerschnitt, siehe Seite 154
Weitere Schaltprogramme ab Seite 132.

Abmessungen in mm:

Typen H216 / H220 / H226 / H233 / B240 / B250 / B263:

Bauform	H1	B1	T1	T2	2×M	H2
715M4	175	115	100	38	20/25	165
715N4	175	115	100	33	20/25	165
715V4	175	115	100	39	20/25	165
725M4	175	115	100	38	20/25	165
725N4	175	115	100	33	20/25	165
725V4	175	115	100	39	20/25	165







Lasttrennschalter



Haupt-/Notausschalter Gekapselte Schalter mit Stahlgehäuse

Haupt-/Notausschalter

- Gekapselte Schalter mit Stahlgehäuse (pulverbeschichtet)
- Deckelverriegelung in EIN-Stellung
- 3- bis 8-polig
- 20 A bis 315 A
- IP66

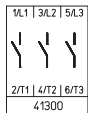



Schaltprogramm	Bemessungsdaten (IEC 60947) Betriebs- Betriebsleistung strom I _e (bei 380–440 V)			Gehäuse- abmessungen (H × B × T) (mm)	Vorhängeschlossperre N-Griff gelb/rot	Vorhängeschlossperre M-Griff gelb/rot	Griffverriegelung V-Griff gelb/rot
	AC-21A (A)	AC-23A (kW)	AC-3 (kW)		  IP66	  IP66	  IP66
					Bestellnummer	Bestellnummer	Bestellnummer
41300 – 3-polig – ohne Hilfskontakte 	20	5,5	3,7	150 × 150 × 120	H216-41300-087N4	H216-41300-087M4	H216-41300-087V4
	20	5,5	3,7	200 × 150 × 120	H216-41300-187N4	H216-41300-187M4	H216-41300-187V4
	25	7,5	5,5	150 × 150 × 120	H220-41300-087N4	H220-41300-087M4	H220-41300-087V4
	25	7,5	5,5	200 × 150 × 120	H220-41300-187N4	H220-41300-187M4	H220-41300-187V4
	32	11	7,5	150 × 150 × 120	H226-41300-087N4	H226-41300-087M4	H226-41300-087V4
	32	11	7,5	200 × 150 × 120	H226-41300-187N4	H226-41300-187M4	H226-41300-187V4
	40	15	11	200 × 150 × 120	H233-41300-187N4	H233-41300-187M4	H233-41300-187V4
	40	15	11	200 × 150 × 120	B240-41300-087N4*	B240-41300-087M4*	B240-41300-087V4*
	50	18,5	15	200 × 150 × 120	B250-41300-087N4	B250-41300-087M4	B250-41300-087V4
	63	22	18,5	200 × 150 × 120	B263-41300-087N4	B263-41300-087M4	B263-41300-087V4
	63	22	18,5	200 × 150 × 120	H406-41300-987N4*	H406-41300-987M4*	–
	63	22	18,5	300 × 250 × 150	H406-41300-187N4	H406-41300-187M4	–
	63	22	18,5	400 × 300 × 155	H406-41300-182N4¹	H406-41300-182M4¹	–
	80	30	22	200 × 150 × 120	H408-41300-987N4	H408-41300-987M4	–
	80	30	22	300 × 250 × 150	H408-41300-187N4	H408-41300-187M4	–
	80	30	22	400 × 300 × 155	H408-41300-182N4¹	H408-41300-182M4¹	–
	100	37	30	300 × 250 × 150	H410-41300-187N4	H410-41300-187M4	–
100	37	30	400 × 300 × 155	H410-41300-182N4¹	H410-41300-182M4¹	–	
125	45	37	300 × 250 × 150	H412-41300-187N4	H412-41300-187M4	–	
125	45	37	400 × 300 × 155	H412-41300-182N4¹	H412-41300-182M4¹	–	

Bemessungsdaten (IEC 60947) Betriebs- Betriebsleistung strom I _e (bei 380–440 V)			Gehäuse- abmessungen (H × B × T) (mm)	Vorhängeschlossperre H-Griff gelb/rot	
AC-21A (A)	AC-23A (kW)	AC-3 (kW)		  IP66	Bestellnummer
160	75	45	500 × 400 × 300	K616-41300-187H4¹	
315	132	55	600 × 400 × 300	K830-41300-187H4¹	
315	132	55	800 × 400 × 300	K830-41300-287H4¹	

* größerer Anschlussquerschnitt, siehe Seite 154

¹ mit Tür

Weitere Schaltprogramme ab Seite 132.

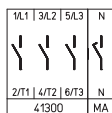
Schaltprogramm	Bemessungsdaten (IEC 60947) Betriebsstrom I_e Betriebsleistung (bei 380–440 V)			Gehäuse- abmessungen (H × B × T) (mm)	Vorhängeschlossperre N-Griff gelb/rot	Vorhängeschlossperre M-Griff gelb/rot	Griffverriegelung V-Griff gelb/rot
	AC-21A (A)	AC-23A (kW)	AC-3 (kW)		 IP66	 IP66	 IP66
					Bestellnummer	Bestellnummer	Bestellnummer
41400 – 4-polig – ohne Hilfskontakte – Neutralleiter voreilend 	20	5,5	3,7	150 × 150 × 120	H216-41400-087N4	H216-41400-087M4	H216-41400-087V4
	20	5,5	3,7	200 × 150 × 120	H216-41400-187N4	H216-41400-187M4	H216-41400-187V4
	25	7,5	5,5	150 × 150 × 120	H220-41400-087N4	H220-41400-087M4	H220-41400-087V4
	25	7,5	5,5	200 × 150 × 120	H220-41400-187N4	H220-41400-187M4	H220-41400-187V4
	32	11	7,5	150 × 150 × 120	H226-41400-087N4	H226-41400-087M4	H226-41400-087V4
	32	11	7,5	200 × 150 × 120	H226-41400-187N4	H226-41400-187M4	H226-41400-187V4
	40	15	11	200 × 150 × 120	H233-41400-187N4	H233-41400-187M4	H233-41400-187V4
	40	15	11	200 × 150 × 120	B240-41400-087N4*	B240-41400-087M4*	B240-41400-087V4*
	50	18,5	15	200 × 150 × 120	B250-41400-087N4	B250-41400-087M4	B250-41400-087V4
	63	22	18,5	200 × 150 × 120	B263-41400-087N4	B263-41400-087M4	B263-41400-087V4
	63	22	18,5	200 × 150 × 120	H406-41400-987N4*	H406-41400-987M4*	–
	63	22	18,5	300 × 250 × 150	H406-41400-187N4	H406-41400-187M4	–
	63	22	18,5	400 × 300 × 155	H406-41400-182N4¹	H406-41400-182M4¹	–
	80	30	22	200 × 150 × 120	H408-41400-987N4	H408-41400-987M4	–
	80	30	22	300 × 250 × 150	H408-41400-187N4	H408-41400-187M4	–
	80	30	22	400 × 300 × 155	H408-41400-182N4¹	H408-41400-182M4¹	–
	100	37	30	300 × 250 × 150	H410-41400-187N4	H410-41400-187M4	–
100	37	30	400 × 300 × 155	H410-41400-182N4¹	H410-41400-182M4¹	–	
125	45	37	300 × 250 × 150	H412-41400-187N4	H412-41400-187M4	–	
125	45	37	400 × 300 × 155	H412-41400-182N4¹	H412-41400-182M4¹	–	

Bemessungsdaten (IEC 60947) Betriebsstrom I_e Betriebsleistung (bei 380–440 V)			Gehäuse- abmessungen (H × B × T) (mm)	Vorhängeschlossperre H-Griff gelb/rot	
AC-21A (A)	AC-23A (kW)	AC-3 (kW)		 IP66	Bestellnummer
160	75	45	500 × 400 × 300		K616-41400-187H4¹
315	132	55	600 × 400 × 300		K830-41400-187H4¹
315	132	55	800 × 400 × 300		K830-41400-287H4¹









* größerer Anschlussquerschnitt, siehe Seite 154

¹ mit Tür

Weitere Schaltprogramme ab Seite 132.

Lasttrennschalter

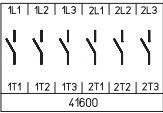
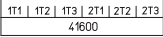



Haupt-/Notausschalter Gekapselte Schalter mit Stahlgehäuse

Schaltprogramm	Bemessungsdaten (IEC 60947) Betriebsstrom I_e Betriebsleistung (bei 380–440 V)			Gehäuse- abmessungen (H × B × T) (mm)	Vorhängeschlossperre N-Griff gelb/rot	Vorhängeschlossperre M-Griff gelb/rot	Griffverriegelung V-Griff gelb/rot
	AC-21A (A)	AC-23A (kW)	AC-3 (kW)		  IP66	  IP66	  IP66
					Bestellnummer	Bestellnummer	Bestellnummer
41600 – 6-polig – ohne Hilfskontakte  	20	5,5	3,7	200 × 150 × 120	H216-41600-187N4	H216-41600-187M4	H216-41600-187V4
	25	7,5	5,5	200 × 150 × 120	H220-41600-187N4	H220-41600-187M4	H220-41600-187V4
	32	11	7,5	200 × 150 × 120	H226-41600-187N4	H226-41600-187M4	H226-41600-187V4
	40	15	11	200 × 150 × 120	H233-41600-187N4	H233-41600-187M4	H233-41600-187V4
	40	15	11	300 × 250 × 150	B240-41600-187N4	B240-41600-187M4	–
	50	18,5	15	300 × 250 × 150	B250-41600-187N4	B250-41600-187M4	–
	63	22	18,5	300 × 250 × 150	B263-41600-187N4	B263-41600-187M4	–
	63	22	18,5	300 × 250 × 150	H406-41600-187N4*	H406-41600-187M4*	–
	63	22	18,5	400 × 300 × 155	H406-41600-182N4¹	H406-41600-182M4¹	–
	80	30	22	300 × 250 × 150	H408-41600-187N4	H408-41600-187M4	–
	80	30	22	400 × 300 × 155	H408-41600-182N4¹	H408-41600-182M4¹	–
	100	37	30	300 × 250 × 150	H410-41600-187N4	H410-41600-187M4	–
	100	37	30	400 × 300 × 155	H410-41600-182N4¹	H410-41600-182M4¹	–
	125	45	37	300 × 250 × 150	H412-41600-187N4	H412-41600-187M4	–
	125	45	37	400 × 300 × 155	H412-41600-182N4¹	H412-41600-182M4¹	–
		Bemessungsdaten (IEC 60947) Betriebsstrom I_e Betriebsleistung (bei 380–440 V)			Gehäuse- abmessungen (H × B × T) (mm)	Vorhängeschlossperre H-Griff gelb/rot	
	AC-21A (A)	AC-23A (kW)	AC-3 (kW)	  IP66			
					Bestellnummer		
	160	75	45	500 × 400 × 300	K616-41600-187H4¹		
	315	132	55	600 × 400 × 300	K830-41600-187H4¹		
	315	132	55	800 × 400 × 300	K830-41600-287H4¹		

* größerer Anschlussquerschnitt, siehe Seite 154

¹ mit Tür

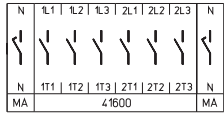
Weitere Schaltprogramme ab Seite 132.

Schaltprogramm	Bemessungsdaten (IEC 60947) Betriebs- Betriebsleistung strom I _e (bei 380–440 V)			Gehäuse- abmessungen (H × B × T) (mm)	Vorhängeschlossperre N-Griff gelb/rot	Vorhängeschlossperre M-Griff gelb/rot	Griffverriegelung V-Griff gelb/rot
	AC-21A (A)	AC-23A (kW)	AC-3 (kW)		 OFF ON IP66	 ON IP66	 ON IP66
	Bestellnummer	Bestellnummer	Bestellnummer				
41800 – 8-polig – ohne Hilfskontakte – 2 Neutralleiter voreilend 	20	5,5	3,7	200 × 150 × 120	H216-41800-187N4	H216-41800-187M4	H216-41800-187V4
	25	7,5	5,5	200 × 150 × 120	H220-41800-187N4	H220-41800-187M4	H220-41800-187V4
	32	11	7,5	200 × 150 × 120	H226-41800-187N4	H226-41800-187M4	H226-41800-187V4
	40	15	11	200 × 150 × 120	H233-41800-187N4	H233-41800-187M4	H233-41800-187V4
	40	15	11	300 × 250 × 150	B240-41800-187N4	B240-41800-187M4	–
	50	18,5	15	300 × 250 × 150	B250-41800-187N4	B250-41800-187M4	–
	63	22	18,5	300 × 250 × 150	B263-41800-187N4	B263-41800-187M4	–
	63	22	18,5	300 × 250 × 150	H406-41800-187N4*	H406-41800-187M4*	–
	63	22	18,5	400 × 300 × 155	H406-41800-182N4¹	H406-41800-182M4¹	–
	80	30	22	300 × 250 × 150	H408-41800-187N4	H408-41800-187M4	–
	80	30	22	400 × 300 × 155	H408-41800-182N4¹	H408-41800-182M4¹	–
	100	37	30	300 × 250 × 150	H410-41800-187N4	H410-41800-187M4	–
	100	37	30	400 × 300 × 155	H410-41800-182N4¹	H410-41800-182M4¹	–
	125	45	37	300 × 250 × 150	H412-41800-187N4	H412-41800-187M4	–
	125	45	37	400 × 300 × 155	H412-41800-182N4¹	H412-41800-182M4¹	–
		Bemessungsdaten (IEC 60947) Betriebs- Betriebsleistung strom I _e (bei 380–440 V)			Gehäuse- abmessungen (H × B × T) (mm)	Vorhängeschlossperre H-Griff gelb/rot	
	AC-21A (A)	AC-23A (kW)	AC-3 (kW)	 ON IP66			
	Bestellnummer						
	160	75	45	500 × 400 × 300	K616-41800-187H4¹		
	315	132	55	600 × 400 × 300	K830-41800-187H4¹		
	315	132	55	800 × 400 × 300	K830-41800-287H4¹		

* größerer Anschlussquerschnitt, siehe Seite 154

¹ mit Tür

Weitere Schaltprogramme ab Seite 132.

Lasttrennschalter

Haupt-/Notausschalter **Gekapselte Schalter** mit Stahlgehäuse

Abmessungen in mm:

Aufbau der Bestellnummer

Typ	Schaltprogramm	Bauform
H216	41400	087M4
Best.-Nr.	H216-41400-087M4	

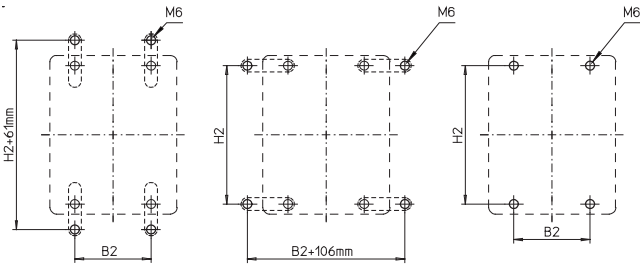
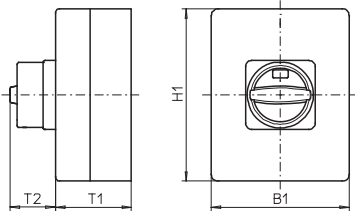

Zugehörige Befestigungslaschen bitte getrennt bestellen, siehe Seite 148.

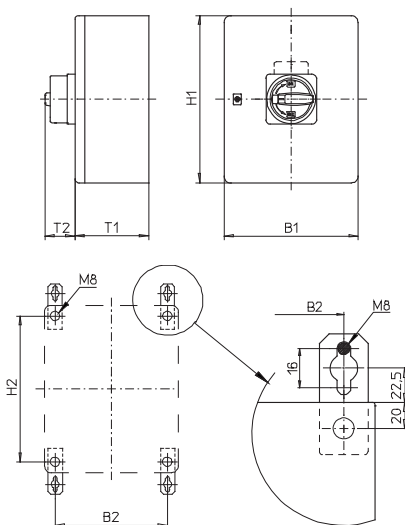

Zugehörige Befestigungslaschen bitte getrennt bestellen, siehe Seite 148.

Stahlgehäuse **150 × 150 × 120 mm / 200 × 150 × 120 mm / 300 × 250 × 150 mm:**

Typen H216 / H220 / H226 / H233:

Bauform	H1	B1	T1	T2	H2	B2
087M4	150	150	120	38	132	85
087N4	150	150	120	33	132	85
087V4	150	150	120	39	132	85
187M4	200	150	120	38	182	85
187N4	200	150	120	33	182	85
187V4	200	150	120	39	182	85

Typen B240 / B250 / B263:

Bauform	H1	B1	T1	T2	H2	B2
087M4	200	150	120	38	182	85
087N4	200	150	120	33	182	85
087V4	200	150	120	39	182	85
187M4	300	250	150	50	282	185
187N4	300	250	150	45	282	185

Typen H406 / H408 / H410 / H412:

Bauform	H1	B1	T1	T2	H2	B2
187M4	300	250	150	50	282	185
187N4	300	250	150	45	282	185
987M4	200	150	120	50	182	85
987N4	200	150	120	45	182	85

Stahlgehäuse **400 × 300 × 155 mm:**

Typen H406 / H408 / H410 / H412:

Bauform	H1	B1	T1	T2	H2	B2
182M4	400	300	155	50	360	260
182N4	400	300	155	45	360	260

Flanschplatte unten

Abmessungen in mm:

Aufbau der Bestellnummer

Typ	Schaltprogramm	Bauform
K616	41300	187H4
Best.-Nr.	K616-41300-187H4	

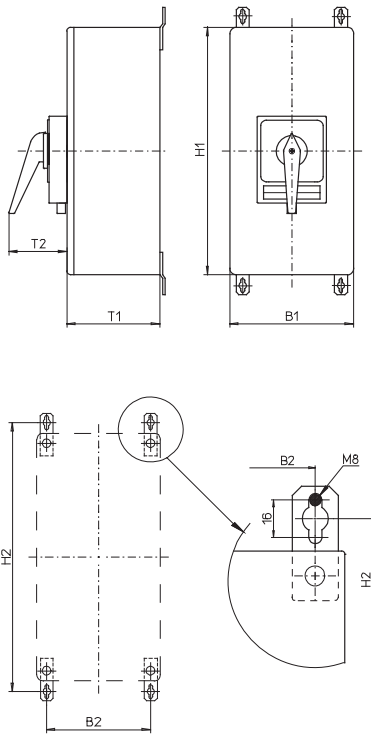

Zugehörige Befestigungslaschen sind im Lieferumfang enthalten.

Stahlgehäuse **500 × 400 × 300 mm / 600 × 400 × 300 mm / 800 × 400 × 300 mm:**

Typ K616:

Bauform	H1	B1	T1	T2	H2	B2
187H4	500	400	300	83	545	360

Typ K830:

Bauform	H1	B1	T1	T2	H2	B2
187H4	600	400	300	93	645	360
287H4	800	400	300	93	845	360

Weitere Schaltprogramme und zugehörige Abmessungen für Typen K auf Anfrage.

Flanschplatte unten





Lasttrennschalter

Haupt-/Notausschalter Gekapselte Schalter mit Edelstahlgehäuse

Haupt-/Notausschalter

- Gekapselte Schalter mit Edelstahlgehäuse (gebürstet)
- Deckelverriegelung in EIN-Stellung
- 3- bis 8-polig
- 20 A bis 125 A
- IP66

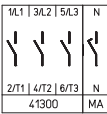

Schaltprogramm	Bemessungsdaten (IEC 60947) Betriebsstrom I_e Betriebsleistung (bei 380–440 V)			Gehäuse- abmessungen (H × B × T) (mm)	Vorhängeschlossperre N-Griff gelb/rot	Vorhängeschlossperre M-Griff gelb/rot	Griffverriegelung V-Griff gelb/rot
	AC-21A (A)	AC-23A (kW)	AC-3 (kW)		 IP66	 IP66	 IP66
					Bestellnummer	Bestellnummer	Bestellnummer
41300 – 3-polig – ohne Hilfskontakte 	20	5,5	3,7	150 × 150 × 120	H216-41300-097N4	H216-41300-097M4	H216-41300-097V4
	20	5,5	3,7	200 × 150 × 120	H216-41300-197N4	H216-41300-197M4	H216-41300-197V4
	25	7,5	5,5	150 × 150 × 120	H220-41300-097N4	H220-41300-097M4	H220-41300-097V4
	25	7,5	5,5	200 × 150 × 120	H220-41300-197N4	H220-41300-197M4	H220-41300-197V4
	32	11	7,5	150 × 150 × 120	H226-41300-097N4	H226-41300-097M4	H226-41300-097V4
	32	11	7,5	200 × 150 × 120	H226-41300-197N4	H226-41300-197M4	H226-41300-197V4
	40	15	11	200 × 150 × 120	H233-41300-197N4	H233-41300-197M4	H233-41300-197V4
	40	15	11	200 × 150 × 120	B240-41300-097N4*	B240-41300-097M4*	B240-41300-097V4*
	50	18,5	15	200 × 150 × 120	B250-41300-097N4	B250-41300-097M4	B250-41300-097V4
	63	22	18,5	200 × 150 × 120	B263-41300-097N4	B263-41300-097M4	B263-41300-097V4
	63	22	18,5	200 × 150 × 120	H406-41300-997N4*	H406-41300-997M4*	–
	63	22	18,5	300 × 250 × 150	H406-41300-197N4	H406-41300-197M4	–
	80	30	22	200 × 150 × 120	H408-41300-997N4	H408-41300-997M4	–
	80	30	22	300 × 250 × 150	H408-41300-197N4	H408-41300-197M4	–
100	37	30	300 × 250 × 150	H410-41300-197N4	H410-41300-197M4	–	
125	45	37	300 × 250 × 150	H412-41300-197N4	H412-41300-197M4	–	
41400 – 4-polig – ohne Hilfskontakte – Neutralleiter voreilend 	20	5,5	3,7	150 × 150 × 120	H216-41400-097N4	H216-41400-097M4	H216-41400-097V4
	20	5,5	3,7	200 × 150 × 120	H216-41400-197N4	H216-41400-197M4	H216-41400-197V4
	25	7,5	5,5	150 × 150 × 120	H220-41400-097N4	H220-41400-097M4	H220-41400-097V4
	25	7,5	5,5	200 × 150 × 120	H220-41400-197N4	H220-41400-197M4	H220-41400-197V4
	32	11	7,5	150 × 150 × 120	H226-41400-097N4	H226-41400-097M4	H226-41400-097V4
	32	11	7,5	200 × 150 × 120	H226-41400-197N4	H226-41400-197M4	H226-41400-197V4
	40	15	11	200 × 150 × 120	H233-41400-197N4	H233-41400-197M4	H233-41400-197V4
	40	15	11	200 × 150 × 120	B240-41400-097N4*	B240-41400-097M4*	B240-41400-097V4*
	50	18,5	15	200 × 150 × 120	B250-41400-097N4	B250-41400-097M4	B250-41400-097V4
	63	22	18,5	200 × 150 × 120	B263-41400-097N4	B263-41400-097M4	B263-41400-097V4
	63	22	18,5	200 × 150 × 120	H406-41400-997N4*	H406-41400-997M4*	–
	63	22	18,5	300 × 250 × 150	H406-41400-197N4	H406-41400-197M4	–
	80	30	22	200 × 150 × 120	H408-41400-997N4	H408-41400-997M4	–
	80	30	22	300 × 250 × 150	H408-41400-197N4	H408-41400-197M4	–
100	37	30	300 × 250 × 150	H410-41400-197N4	H410-41400-197M4	–	
125	45	37	300 × 250 × 150	H412-41400-197N4	H412-41400-197M4	–	

* größerer Anschlussquerschnitt, siehe Seite 154

Weitere Schaltprogramme ab Seite 132.

Lasttrennschalter

Haupt-/Notausschalter Gekapselte Schalter mit Edelstahlgehäuse

Schaltprogramm	Bemessungsdaten (IEC 60947) Betriebsstrom I_e Betriebsleistung (bei 380–440 V)			Gehäuse- abmessungen (H × B × T) (mm)	Vorhängeschlossperre N-Griff gelb/rot 	Vorhängeschlossperre M-Griff gelb/rot 	Griffverriegelung V-Griff gelb/rot
	AC-21A (A)	AC-23A (kW)	AC-3 (kW)		IP66	IP66	IP66
					Bestellnummer	Bestellnummer	Bestellnummer
41600 – 6-polig – ohne Hilfskontakte 	20	5,5	3,7	200 × 150 × 120	H216-41600-197N4	H216-41600-197M4	H216-41600-197V4
	25	7,5	5,5	200 × 150 × 120	H220-41600-197N4	H220-41600-197M4	H220-41600-197V4
	32	11	7,5	200 × 150 × 120	H226-41600-197N4	H226-41600-197M4	H226-41600-197V4
	40	15	11	200 × 150 × 120	H233-41600-197N4	H233-41600-197M4	H233-41600-197V4
	40	15	11	300 × 250 × 150	B240-41600-197N4	B240-41600-197M4	–
	50	18,5	15	300 × 250 × 150	B250-41600-197N4	B250-41600-197M4	–
	63	22	18,5	300 × 250 × 150	B263-41600-197N4	B263-41600-197M4	–
	63	22	18,5	300 × 250 × 150	H406-41600-197N4*	H406-41600-197M4*	–
	80	30	22	300 × 250 × 150	H408-41600-197N4	H408-41600-197M4	–
	100	37	30	300 × 250 × 150	H410-41600-197N4	H410-41600-197M4	–
125	45	37	300 × 250 × 150	H412-41600-197N4	H412-41600-197M4	–	
41800 – 8-polig – ohne Hilfskontakte – 2 Neutralleiter voreilend 	20	5,5	3,7	200 × 150 × 120	H216-41800-197N4	H216-41800-197M4	H216-41800-197V4
	25	7,5	5,5	200 × 150 × 120	H220-41800-197N4	H220-41800-197M4	H220-41800-197V4
	32	11	7,5	200 × 150 × 120	H226-41800-197N4	H226-41800-197M4	H226-41800-197V4
	40	15	11	200 × 150 × 120	H233-41800-197N4	H233-41800-197M4	H233-41800-197V4
	40	15	11	300 × 250 × 150	B240-41800-197N4	B240-41800-197M4	–
	50	18,5	15	300 × 250 × 150	B250-41800-197N4	B250-41800-197M4	–
	63	22	18,5	300 × 250 × 150	B263-41800-197N4	B263-41800-197M4	–
	63	22	18,5	300 × 250 × 150	H406-41800-197N4*	H406-41800-197M4*	–
	80	30	22	300 × 250 × 150	H408-41800-197N4	H408-41800-197M4	–
	100	37	30	300 × 250 × 150	H410-41800-197N4	H410-41800-197M4	–
125	45	37	300 × 250 × 150	H412-41800-197N4	H412-41800-197M4	–	

* größerer Anschlussquerschnitt, siehe Seite 154
 Weitere Schaltprogramme ab Seite 132.

Abmessungen in mm:

Aufbau der Bestellnummer

Typ	Schaltprogramm	Bauform
B263	41800	197V4
Best.-Nr.	B263-41800-197V4	

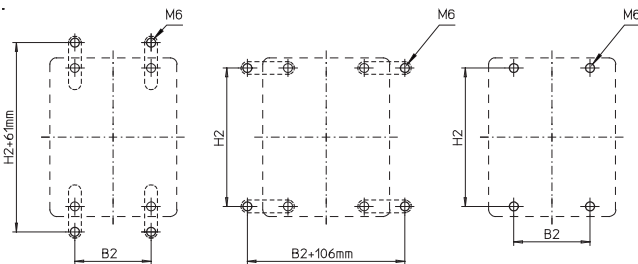
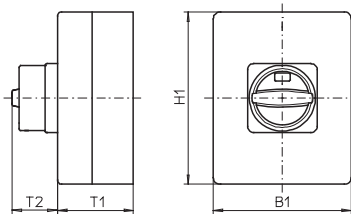

Zugehörige Befestigungslaschen bitte getrennt bestellen, siehe Seite 148.

Typen H216 / H220 / H226 / H233:

Bauform	H1	B1	T1	T2	H2	B2
097M4	150	150	120	38	132	85
097N4	150	150	120	33	132	85
097V4	150	150	120	39	132	85
197M4	200	150	120	38	182	85
197N4	200	150	120	33	182	85
197V4	200	150	120	39	182	85

Typen B240 / B250 / B263:

Bauform	H1	B1	T1	T2	H2	B2
097M4	200	150	120	38	182	85
097N4	200	150	120	33	182	85
097V4	200	150	120	39	182	85
197M4	300	250	150	50	282	185
197N4	300	250	150	45	282	185

Typen H406 / H408 / H410 / H412:

Bauform	H1	B1	T1	T2	H2	B2
197M4	300	250	150	50	282	185
197N4	300	250	150	45	282	185
997M4	200	150	120	50	182	85
997N4	200	150	120	45	182	85







Lasttrennschalter

Hauptschalter Fronteinbau Vierlochbefestigung

Hauptschalter

- Fronteinbauswitcher mit Vierlochbefestigung
- 3- bis 8-polig
- 20 A bis 315 A
- IP66 / IP55



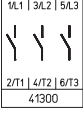



Schaltprogramm	Bemessungsdaten (IEC 60947) Betriebs- Betriebsleistung strom I _e (bei 380–440 V)			Befestigungsmaß (mm)	Vorhängeschlosssperre N-Griff schwarz	Vorhängeschlosssperre M-Griff schwarz	Griffverriegelung V-Griff silber/schwarz
	AC-21A (A)	AC-23A (kW)	AC-3 (kW)		  IP66	  IP66	  IP66
					Bestellnummer	Bestellnummer	Bestellnummer
41300 – 3-polig – ohne Hilfskontakte 	20	5,5	3,7	36 × 36	H216-41300-033N1	H216-41300-033M1	H216-41300-033V1
	20	5,5	3,7	48 × 48	H216-41300-036N1	H216-41300-036M1	H216-41300-036V1
	25	7,5	5,5	36 × 36	H220-41300-033N1	H220-41300-033M1	H220-41300-033V1
	25	7,5	5,5	48 × 48	H220-41300-036N1	H220-41300-036M1	H220-41300-036V1
	32	11	7,5	36 × 36	H226-41300-033N1	H226-41300-033M1	H226-41300-033V1
	32	11	7,5	48 × 48	H226-41300-036N1	H226-41300-036M1	H226-41300-036V1
	40	15	11	36 × 36	H233-41300-033N1	H233-41300-033M1	H233-41300-033V1
	40	15	11	36 × 36	B240-41300-033N1*	B240-41300-033M1*	B240-41300-033V1*
	40	15	11	48 × 48	H233-41300-036N1	H233-41300-036M1	H233-41300-036V1
	40	15	11	48 × 48	B240-41300-036N1*	B240-41300-036M1*	B240-41300-036V1*
	40	15	11	68 × 68	B240-41300-136N1	B240-41300-136M1	–
	50	18,5	15	36 × 36	B250-41300-033N1	B250-41300-033M1	B250-41300-033V1
	50	18,5	15	48 × 48	B250-41300-036N1	B250-41300-036M1	B250-41300-036V1
	50	18,5	15	68 × 68	B250-41300-136N1	B250-41300-136M1	–
	63	22	18,5	36 × 36	B263-41300-033N1	B263-41300-033M1	B263-41300-033V1
	63	22	18,5	48 × 48	B263-41300-036N1	B263-41300-036M1	B263-41300-036V1
	63	22	18,5	48 × 48	H406-41300-033N1*	H406-41300-033M1*	H406-41300-033V1*
	63	22	18,5	68 × 68	B263-41300-136N1	B263-41300-136M1	–
63	22	18,5	68 × 68	H406-41300-036N1*	H406-41300-036M1*	–	
80	30	22	48 × 48	H408-41300-033N1	H408-41300-033M1	H408-41300-033V1	
80	30	22	68 × 68	H408-41300-036N1	H408-41300-036M1	–	
100	37	30	48 × 48	H410-41300-033N1	H410-41300-033M1	H410-41300-033V1	
100	37	30	68 × 68	H410-41300-036N1	H410-41300-036M1	–	
125	45	37	48 × 48	H412-41300-033N1	H412-41300-033M1	H412-41300-033V1	
125	45	37	68 × 68	H412-41300-036N1	H412-41300-036M1	–	

Bemessungsdaten (IEC 60947) Betriebs- Betriebsleistung strom I _e (bei 380–440 V)			Befestigungsmaß (mm)	Vorhängeschlosssperre H-Griff silber/schwarz
AC-21A (A)	AC-23A (kW)	AC-3 (kW)		 IP55
				Bestellnummer
160	75	45	68 × 68	K616-41300-033H1
315	132	55	104 × 104	K830-41300-033H1

* größerer Anschlussquerschnitt, siehe Seite 154

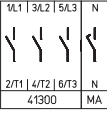
Weitere Schaltprogramme ab Seite 132.

Schaltprogramm	Bemessungsdaten (IEC 60947) Betriebsstrom I_e Betriebsleistung (bei 380–440 V)			Befestigungsmaß (mm)	Vorhängeschlossperre N-Griff schwarz 	Vorhängeschlossperre M-Griff schwarz 	Griffverriegelung V-Griff silber/schwarz 
	AC-21A (A)	AC-23A (kW)	AC-3 (kW)		IP66	IP66	IP66
					Bestellnummer	Bestellnummer	Bestellnummer
41400 – 4-polig – ohne Hilfskontakte – Neutralleiter voreilend 	20	5,5	3,7	36 × 36	H216-41400-033N1	H216-41400-033M1	H216-41400-033V1
	20	5,5	3,7	48 × 48	H216-41400-036N1	H216-41400-036M1	H216-41400-036V1
	25	7,5	5,5	36 × 36	H220-41400-033N1	H220-41400-033M1	H220-41400-033V1
	25	7,5	5,5	48 × 48	H220-41400-036N1	H220-41400-036M1	H220-41400-036V1
	32	11	7,5	36 × 36	H226-41400-033N1	H226-41400-033M1	H226-41400-033V1
	32	11	7,5	48 × 48	H226-41400-036N1	H226-41400-036M1	H226-41400-036V1
	40	15	11	36 × 36	H233-41400-033N1	H233-41400-033M1	H233-41400-033V1
	40	15	11	36 × 36	B240-41400-033N1*	B240-41400-033M1*	B240-41400-033V1*
	40	15	11	48 × 48	H233-41400-036N1	H233-41400-036M1	H233-41400-036V1
	40	15	11	48 × 48	B240-41400-036N1*	B240-41400-036M1*	B240-41400-036V1*
	40	15	11	68 × 68	B240-41400-136N1	B240-41400-136M1	–
	50	18,5	15	36 × 36	B250-41400-033N1	B250-41400-033M1	B250-41400-033V1
	50	18,5	15	48 × 48	B250-41400-036N1	B250-41400-036M1	B250-41400-036V1
	50	18,5	15	68 × 68	B250-41400-136N1	B250-41400-136M1	–
	63	22	18,5	36 × 36	B263-41400-033N1	B263-41400-033M1	B263-41400-033V1
	63	22	18,5	48 × 48	B263-41400-036N1	B263-41400-036M1	B263-41400-036V1
	63	22	18,5	48 × 48	H406-41400-033N1*	H406-41400-033M1*	H406-41400-033V1*
	63	22	18,5	68 × 68	B263-41400-136N1	B263-41400-136M1	–
	63	22	18,5	68 × 68	H406-41400-036N1*	H406-41400-036M1*	–
	80	30	22	48 × 48	H408-41400-033N1	H408-41400-033M1	H408-41400-033V1
80	30	22	68 × 68	H408-41400-036N1	H408-41400-036M1	–	
100	37	30	48 × 48	H410-41400-033N1	H410-41400-033M1	H410-41400-033V1	
100	37	30	68 × 68	H410-41400-036N1	H410-41400-036M1	–	
125	45	37	48 × 48	H412-41400-033N1	H412-41400-033M1	H412-41400-033V1	
125	45	37	68 × 68	H412-41400-036N1	H412-41400-036M1	–	

Bemessungsdaten (IEC 60947) Betriebsstrom I_e Betriebsleistung (bei 380–440 V)			Befestigungsmaß (mm)	Vorhängeschlossperre H-Griff silber/schwarz 
AC-21A (A)	AC-23A (kW)	AC-3 (kW)		IP55
				Bestellnummer
160	75	45	68 × 68	K616-41400-033H1
315	132	55	104 × 104	K830-41400-033H1

* größerer Anschlussquerschnitt, siehe Seite 154

Weitere Schaltprogramme ab Seite 132.

Lasttrennschalter

Hauptschalter Fronteinbau Vierlochbefestigung

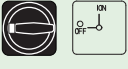
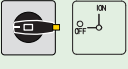
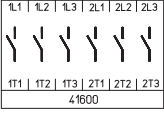
Schaltprogramm	Bemessungsdaten (IEC 60947) Betriebsstrom I_e Betriebsleistung (bei 380–440 V)			Befestigungsmaß (mm)	Vorhängeschlossperre N-Griff schwarz	Vorhängeschlossperre M-Griff schwarz	Griffverriegelung V-Griff silber/schwarz
	AC-21A (A)	AC-23A (kW)	AC-3 (kW)				
					Bestellnummer	Bestellnummer	Bestellnummer
41600 – 6-polig – ohne Hilfskontakte 	20	5,5	3,7	36 × 36	H216-41600-033N1	H216-41600-033M1	–
	20	5,5	3,7	48 × 48	H216-41600-036N1	H216-41600-036M1	H216-41600-036V1
	20	5,5	3,7	68 × 68	H216-41600-136N1	H216-41600-136M1	–
	25	7,5	5,5	36 × 36	H220-41600-033N1	H220-41600-033M1	–
	25	7,5	5,5	48 × 48	H220-41600-036N1	H220-41600-036M1	H220-41600-036V1
	25	7,5	7,5	68 × 68	H220-41600-136N1	H220-41600-136M1	–
	32	11	7,5	36 × 36	H226-41600-033N1	H226-41600-033M1	–
	32	11	7,5	48 × 48	H226-41600-036N1	H226-41600-036M1	H226-41600-036V1
	32	11	7,5	68 × 68	H226-41600-136N1	H226-41600-136M1	–
	40	15	11	36 × 36	H233-41600-033N1	H233-41600-033M1	–
	40	15	11	36 × 36	B240-41600-033N1*	B240-41600-033M1*	–
	40	15	11	48 × 48	H233-41600-036N1	H233-41600-036M1	H233-41600-036V1
	40	15	11	48 × 48	B240-41600-036N1*	B240-41600-036M1*	B240-41600-036V1
	40	15	11	68 × 68	H233-41600-136N1	H233-41600-136M1	–
	40	15	11	68 × 68	B240-41600-136N1*	B240-41600-136M1*	–
	50	18,5	15	36 × 36	B250-41600-033N1	B250-41600-033M1	–
	50	18,5	15	48 × 48	B250-41600-036N1	B250-41600-036M1	B250-41600-036V1
	50	18,5	15	68 × 68	B250-41600-136N1	B250-41600-136M1	–
	63	22	18,5	36 × 36	B263-41600-033N1	B263-41600-033M1	–
	63	22	18,5	48 × 48	B263-41600-036N1	B263-41600-036M1	B263-41600-036V1
	63	22	18,5	48 × 48	H406-41600-033N1*	H406-41600-033M1*	H406-41600-033V1*
	63	22	18,5	68 × 68	B263-41600-136N1	B263-41600-136M1	–
	63	22	18,5	68 × 68	H406-41600-036N1*	H406-41600-036M1*	–
80	30	22	48 × 48	H408-41600-033N1	H408-41600-033M1	H408-41600-033V1	
80	30	22	68 × 68	H408-41600-036N1	H408-41600-036M1	–	
100	37	30	48 × 48	H410-41600-033N1	H410-41600-033M1	H410-41600-033V1	
100	37	30	68 × 68	H410-41600-036N1	H410-41600-036M1	–	
125	45	37	48 × 48	H412-41600-033N1	H412-41600-033M1	H412-41600-033V1	
125	45	37	68 × 68	H412-41600-036N1	H412-41600-036M1	–	

Bemessungsdaten (IEC 60947) Betriebsstrom I_e Betriebsleistung (bei 380–440 V)			Befestigungsmaß (mm)	Vorhängeschlossperre H-Griff silber/schwarz
AC-21A (A)	AC-23A (kW)	AC-3 (kW)		
				Bestellnummer
160	75	45	68 × 68	K616-41600-033H1
315	132	55	104 × 104	K830-41600-033H1

* größerer Anschlussquerschnitt, siehe Seite 154

Weitere Schaltprogramme ab Seite 132.

Schaltprogramm	Bemessungsdaten (IEC 60947) Betriebsstrom I_e Betriebsleistung (bei 380–440 V)			Befestigungsmaß (mm)	Vorhängeschlossperre N-Griff schwarz	Vorhängeschlossperre M-Griff schwarz	Griffverriegelung V-Griff silber/schwarz
	AC-21A (A)	AC-23A (kW)	AC-3 (kW)				
					Bestellnummer	Bestellnummer	Bestellnummer
41800 – 8-polig – ohne Hilfskontakte – 2 Neutralleiter voreilend 	20	5,5	3,7	36 × 36	H216-41800-033N1	H216-41800-033M1	–
	20	5,5	3,7	48 × 48	H216-41800-036N1	H216-41800-036M1	H216-41800-036V1
	20	5,5	3,7	68 × 68	H216-41800-136N1	H216-41800-136M1	–
	25	7,5	5,5	36 × 36	H220-41800-033N1	H220-41800-033M1	–
	25	7,5	5,5	48 × 48	H220-41800-036N1	H220-41800-036M1	H220-41800-036V1
	25	7,5	5,5	68 × 68	H220-41800-136N1	H220-41800-136M1	–
	32	11	7,5	36 × 36	H226-41800-033N1	H226-41800-033M1	–
	32	11	7,5	48 × 48	H226-41800-036N1	H226-41800-036M1	H226-41800-036V1
	32	11	7,5	68 × 68	H226-41800-136N1	H226-41800-136M1	–
	40	15	11	36 × 36	H233-41800-033N1	H233-41800-033M1	–
	40	15	11	36 × 36	B240-41800-033N1*	B240-41800-033M1*	–
	40	15	11	48 × 48	H233-41800-036N1	H233-41800-036M1	H233-41800-036V1
	40	15	11	48 × 48	B240-41800-036N1*	B240-41800-036M1*	B240-41800-036V1*
	40	15	11	68 × 68	H233-41800-136N1	H233-41800-136M1	–
	40	15	11	68 × 68	B240-41800-136N1*	B240-41800-136M1*	–
	50	18,5	15	36 × 36	B250-41800-033N1	B250-41800-033M1	–
	50	18,5	15	48 × 48	B250-41800-036N1	B250-41800-036M1	B250-41800-036V1
	50	18,5	15	68 × 68	B250-41800-136N1	B250-41800-136M1	–
	63	22	18,5	36 × 36	B263-41800-033N1	B263-41800-033M1	–
	63	22	18,5	48 × 48	B263-41800-036N1	B263-41800-036M1	B263-41800-036V1
63	22	18,5	48 × 48	H406-41800-033N1*	H406-41800-033M1*	H406-41800-033V1*	
63	22	18,5	68 × 68	B263-41800-136N1	B263-41800-136M1	–	
63	22	18,5	68 × 68	H406-41800-036N1*	H406-41800-036M1*	–	
80	30	22	48 × 48	H408-41800-033N1	H408-41800-033M1	H408-41800-033V1	
80	30	22	68 × 68	H408-41800-036N1	H408-41800-036M1	–	
100	37	30	48 × 48	H410-41800-033N1	H410-41800-033M1	H410-41800-033V1	
100	37	30	68 × 68	H410-41800-036N1	H410-41800-036M1	–	
125	45	37	48 × 48	H412-41800-033N1	H412-41800-033M1	H412-41800-033V1	
125	45	37	68 × 68	H412-41800-036N1	H412-41800-036M1	–	

Bemessungsdaten (IEC 60947) Betriebsstrom I_e Betriebsleistung (bei 380–440 V)			Befestigungsmaß (mm)	Vorhängeschlossperre H-Griff silber/schwarz
AC-21A (A)	AC-23A (kW)	AC-3 (kW)		
				Bestellnummer
160	75	45	68 × 68	K616-41800-033H1
315	132	55	104 × 104	K830-41800-033H1

* größerer Anschlussquerschnitt, siehe Seite 154

Weitere Schaltprogramme ab Seite 132.

Lasttrennschalter

Hauptschalter Fronteinbau Vierlochbefestigung

Abmessungen in mm:

Aufbau der Bestellnummer		
Typ	Schaltprogramm	Bauform
H216	41800	036N1
Best.-Nr. H216-41800-036N1		

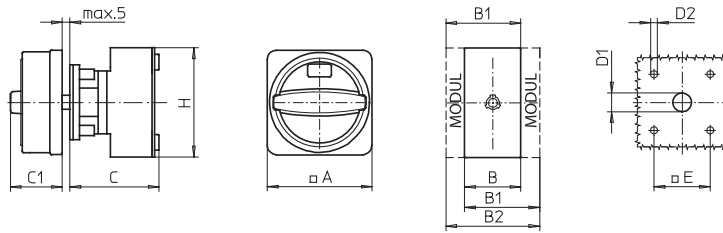

Schaltprogramme 3- und 4-polig

Typen H216 / H220 / H226 / H233:

Bauform	A	B	B1	B2	C	C1	D1	D2	E	H
033M1	67	36	48	60	58	38	15	4,5	36	70
033N1	67	36	48	60	58	33	15	4,5	36	70
033V1	48	36	48	60	58	32	12	4,5	36	70
036M1	67	36	48	60	58	38	15	5	48	70
036N1	67	36	48	60	58	33	15	5	48	70
036V1	64	36	48	60	58	39	15	5	48	70

Typen B240 / B250 / B263:

Bauform	A	B	B1	B2	C	C1	D1	D2	E	H
033M1	67	50	69	88	58	38	15	4,5	36	72
033N1	67	50	69	88	58	33	15	4,5	36	72
033V1	48	50	69	88	58	32	12	4,5	36	72
036M1	67	50	69	88	58	38	15	5	48	72
036N1	67	50	69	88	58	33	15	5	48	72
036V1	64	50	69	88	58	39	15	5	48	72
136M1	88	50	69	88	58	50	15	5,5	68	72
136N1	88	50	69	88	58	45	15	5,5	68	72

Typen H406 / H408 / H410 / H412:

Bauform	A	B	B1	B2	C	C1	D1	D2	E	H
033M1	88	70	89	108	73	50	15	5	48	80
033N1	88	70	89	108	73	45	15	5	48	80
033V1	64	70	89	108	73	39	15	5	48	80
036M1	88	70	89	108	73	50	15	5,5	68	80
036N1	88	70	89	108	73	45	15	5,5	68	80

Schaltprogramme 6- und 8-polig

Typen H216 / H220 / H226 / H233:

Bauform	A	B	B1	B2	C	C1	D1	D2	E	H
033M1	67	72	84	96	66	38	15	4,5	36	70
033N1	67	72	84	96	66	33	15	4,5	36	70
036M1	67	72	84	96	66	38	15	5	48	70
036N1	67	72	84	96	66	33	15	5	48	70
036V1	64	72	84	96	66	39	15	5	48	70
136M1	88	72	84	96	66	38	15	5,5	68	70
136N1	88	72	84	96	66	33	15	5,5	68	70

Typen B240 / B250 / B263:

Bauform	A	B	B1	B2	C	C1	D1	D2	E	H
033M1	67	100	119	138	70	38	15	4,5	36	72
033N1	67	100	119	138	70	33	15	4,5	36	72
036M1	67	100	119	138	70	38	15	5	48	72
036N1	67	100	119	138	70	33	15	5	48	72
036V1	64	100	119	138	70	39	15	5	48	72
136M1	88	100	119	138	70	50	15	5,5	68	72
136N1	88	100	119	138	70	45	15	5,5	68	72

Typen H406 / H408 / H410 / H412:

Bauform	A	B	B1	B2	C	C1	D1	D2	E	H
033M1	88	140	159	178	86	50	15	5	48	80
033N1	88	140	159	178	86	45	15	5	48	80
033V1	64	140	159	178	86	39	15	5	48	80
036M1	88	140	159	178	86	50	15	5,5	68	80
036N1	88	140	159	178	86	45	15	5,5	68	80

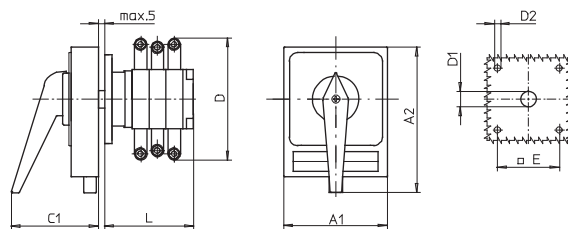

Typen K616 / K830:

Typ	Bauform	Schaltprogramm	A1	A2	C1	D*	D1	D2	E	L
K616	033H1	41300	98	142	83	150	20	5,5	68	104
K616	033H1	41400	98	142	83	150	20	5,5	68	104
K830	033H1	41300	130	178	93	210	20	5,5	104	125
K830	033H1	41400	130	178	93	210	20	5,5	104	125

Typen K616 / K830:

Typ	Bauform	Schaltprogramm	A1	A2	C1	D*	D1	D2	E	L
K616	033H1	41600	98	142	83	150	20	5,5	68	136
K616	033H1	41800	98	142	83	150	20	5,5	68	168
K830	033H1	41600	130	178	93	210	20	5,5	104	161
K830	033H1	41800	130	178	93	210	20	5,5	104	197



Weitere Schaltprogramme und zugehörige Abmessungen für Typen K auf Anfrage.

* einschließlich Anschlusswinkel

Hauptschalter

- Fronteinbauswitcher mit Zentralbefestigung
- 3- bis 8-polig
- 20 A bis 63 A
- IP66



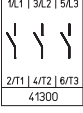
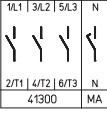











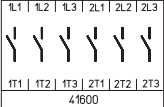























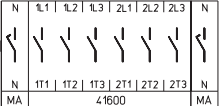













Schaltprogramm	Bemessungsdaten (IEC 60947) Betriebsstrom I_e Betriebsleistung (bei 380–440 V)			Befestigungsmaß (mm)	Vorhängeschlossperre N-Griff schwarz	Vorhängeschlossperre M-Griff schwarz	Griffverriegelung V-Griff silber/schwarz
	AC-21A (A)	AC-23A (kW)	AC-3 (kW)				
					IP66	IP66	IP66
					Bestellnummer	Bestellnummer	Bestellnummer
41300 – 3-polig – ohne Hilfskontakte 	20	5,5	3,7	∅ 22,5	H216-41300-206N1	H216-41300-206M1	H216-41300-206V1
	20	5,5	3,7	∅ 30,5	H216-41300-216N1	H216-41300-216M1	H216-41300-216V1
	25	7,5	5,5	∅ 22,5	H220-41300-206N1	H220-41300-206M1	H220-41300-206V1
	25	7,5	5,5	∅ 30,5	H220-41300-216N1	H220-41300-216M1	H220-41300-216V1
	32	11	7,5	∅ 22,5	H226-41300-206N1	H226-41300-206M1	H226-41300-206V1
	32	11	7,5	∅ 30,5	H226-41300-216N1	H226-41300-216M1	H226-41300-216V1
	40	15	11	∅ 22,5	H233-41300-206N1	H233-41300-206M1	H233-41300-206V1
	40	15	11	∅ 22,5	B240-41300-206N1*	B240-41300-206M1*	B240-41300-206V1*
	40	15	11	∅ 30,5	H233-41300-216N1	H233-41300-216M1	H233-41300-216V1
	40	15	11	∅ 30,5	B240-41300-216N1*	B240-41300-216M1*	B240-41300-216V1*
	50	18,5	15	∅ 22,5	B250-41300-206N1	B250-41300-206M1	B250-41300-206V1
	50	18,5	15	∅ 30,5	B250-41300-216N1	B250-41300-216M1	B250-41300-216V1
	63	22	18,5	∅ 22,5	B263-41300-206N1	B263-41300-206M1	B263-41300-206V1
	63	22	18,5	∅ 30,5	B263-41300-216N1	B263-41300-216M1	B263-41300-216V1
41400 – 4-polig – ohne Hilfskontakte – Neutralleiter voreilend 	20	5,5	3,7	∅ 22,5	H216-41400-206N1	H216-41400-206M1	H216-41400-206V1
	20	5,5	3,7	∅ 30,5	H216-41400-216N1	H216-41400-216M1	H216-41400-216V1
	25	7,5	5,5	∅ 22,5	H220-41400-206N1	H220-41400-206M1	H220-41400-206V1
	25	7,5	5,5	∅ 30,5	H220-41400-216N1	H220-41400-216M1	H220-41400-216V1
	32	11	7,5	∅ 22,5	H226-41400-206N1	H226-41400-206M1	H226-41400-206V1
	32	11	7,5	∅ 30,5	H226-41400-216N1	H226-41400-216M1	H226-41400-216V1
	40	15	11	∅ 22,5	H233-41400-206N1	H233-41400-206M1	H233-41400-206V1
	40	15	11	∅ 22,5	B240-41400-206N1*	B240-41400-206M1*	B240-41400-206V1*
	40	15	11	∅ 30,5	H233-41400-216N1	H233-41400-216M1	H233-41400-216V1
	40	15	11	∅ 30,5	B240-41400-216N1*	B240-41400-216M1*	B240-41400-216V1*
	50	18,5	15	∅ 22,5	B250-41400-206N1	B250-41400-206M1	B250-41400-206V1
	50	18,5	15	∅ 30,5	B250-41400-216N1	B250-41400-216M1	B250-41400-216V1
	63	22	18,5	∅ 22,5	B263-41400-206N1	B263-41400-206M1	B263-41400-206V1
	63	22	18,5	∅ 30,5	B263-41400-216N1	B263-41400-216M1	B263-41400-216V1

* größerer Anschlussquerschnitt, siehe Seite 154

Weitere Schaltprogramme ab Seite 132.

Lasttrennschalter

Hauptschalter Fronteinbau Zentralbefestigung

Schaltprogramm	Bemessungsdaten (IEC 60947) Betriebsstrom I _e Betriebsleistung (bei 380–440 V)			Befestigungsmaß (mm)	Vorhängeschlossperre N-Griff schwarz	Vorhängeschlossperre M-Griff schwarz	Griffverriegelung V-Griff silber/schwarz
	AC-21A (A)	AC-23A (kW)	AC-3 (kW)				
41600 – 6-polig – ohne Hilfskontakte 	20	5,5	3,7	∅ 22,5			
	20	5,5	3,7	∅ 30,5			
	25	7,5	5,5	∅ 22,5			
	25	7,5	5,5	∅ 30,5			
	32	11	7,5	∅ 22,5			
	32	11	7,5	∅ 30,5			
	40	15	11	∅ 22,5			
	40	15	11	∅ 30,5			
41800 – 8-polig – ohne Hilfskontakte – 2 Neutralleiter voreilend 	20	5,5	3,7	∅ 22,5			
	20	5,5	3,7	∅ 30,5			
	25	7,5	5,5	∅ 22,5			
	25	7,5	5,5	∅ 30,5			
	32	11	7,5	∅ 22,5			
	32	11	7,5	∅ 30,5			
40	15	11	∅ 22,5				
40	15	11	∅ 30,5				

Weitere Schaltprogramme ab Seite 132.

Abmessungen in mm:

Aufbau der Bestellnummer		
Typ	Schaltprogramm	Bauform
H226	41300	206N1
Best.-Nr.	H226-41300-206N1	

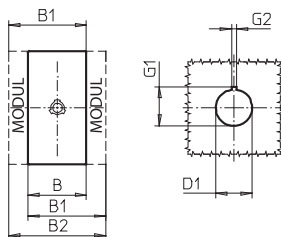
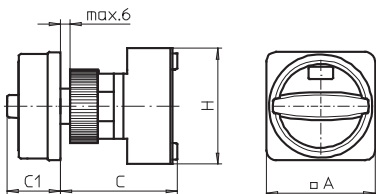

Schaltprogramme 3- und 4-polig

Typen H216 / H220 / H226 / H233:

Bauform	A	B	B1	B2	C	C1	D1	G1	G2	H
206M1	67	36	48	60	75	38	22,5	24,2	3,2	70
206N1	67	36	48	60	75	33	22,5	24,2	3,2	70
206V1	48	36	48	60	75	32	22,5	24,2	3,2	70
216M1	67	36	48	60	75	38	30,5	33	4,8	70
216N1	67	36	48	60	75	33	30,5	33	4,8	70
216V1	64	36	48	60	75	39	30,5	33	4,8	70

Typen B240 / B250 / B263:

Bauform	A	B	B1	B2	C	C1	D1	G1	G2	H
206M1	67	50	69	88	75	38	22,5	24,2	3,2	72
206N1	67	50	69	88	75	33	22,5	24,2	3,2	72
206V1	48	50	69	88	75	32	22,5	24,2	3,2	72
216M1	67	50	69	88	75	38	30,5	33	4,8	72
216N1	67	50	69	88	75	33	30,5	33	4,8	72
216V1	64	50	69	88	75	39	30,5	33	4,8	72

Schaltprogramme 6- und 8-polig



Typen H216 / H220 / H226 / H233:

Bauform	A	B	B1	B2	C	C1	D1	G1	G2	H
206M1	67	72	84	96	83	38	22,5	24,2	3,2	70
206N1	67	72	84	96	83	33	22,5	24,2	3,2	70
216M1	67	72	84	96	83	38	30,5	33	4,8	70
216N1	67	72	84	96	83	33	30,5	33	4,8	70
216V1	64	72	84	96	83	39	30,5	33	4,8	70

Hauptschalter

- Bodeneinbauschalter mit Schnappbefestigung
- für Installationsverteiler
- 3- bis 8-polig
- 20 A bis 125 A
- IP30

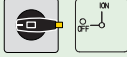

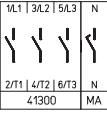
Schaltprogramm	Bemessungsdaten (IEC 60947) Betriebs- Betriebsleistung strom I _e (bei 380–440 V)			Frontschildmaß für Normausschnitt 45 mm (H × B) (mm)	Griffverriegelung V-Griff grau/schwarz  IP30	Bestellnummer
	AC-21A (A)	AC-23A (kW)	AC-3 (kW)			
41300 – 3-polig – ohne Hilfskontakte 	20	5,5	3,7	45 × 48	H216-41300-026V1	
	20	5,5	3,7	45 × 60	H216-41300-126V1	
	25	7,5	5,5	45 × 48	H220-41300-026V1	
	25	7,5	5,5	45 × 60	H220-41300-126V1	
	32	11	7,5	45 × 48	H226-41300-026V1	
	32	11	7,5	45 × 60	H226-41300-126V1	
	40	15	11	45 × 48	H233-41300-026V1	
	40	15	11	45 × 52,5	B240-41300-026V1*	
	40	15	11	45 × 60	H233-41300-126V1	
	50	18,5	15	45 × 52,5	B250-41300-026V1	
	63	22	18,5	45 × 52,5	B263-41300-026V1	
	63	22	18,5	45 × 72	H406-41300-126V1*	
	80	30	22	45 × 72	H408-41300-126V1	
	100	37	30	45 × 72	H410-41300-126V1	
125	45	37	45 × 72	H412-41300-126V1		
41400 – 4-polig – ohne Hilfskontakte – Neutralleiter voreilend 	20	5,5	3,7	45 × 48	H216-41400-026V1	
	20	5,5	3,7	45 × 60	H216-41400-126V1	
	25	7,5	5,5	45 × 48	H220-41400-026V1	
	25	7,5	5,5	45 × 60	H220-41400-126V1	
	32	11	7,5	45 × 48	H226-41400-026V1	
	32	11	7,5	45 × 60	H226-41400-126V1	
	40	15	11	45 × 48	H233-41400-026V1	
	40	15	11	45 × 52,5	B240-41400-026V1*	
	40	15	11	45 × 60	H233-41400-126V1	
	50	18,5	15	45 × 52,5	B250-41400-026V1	
	63	22	18,5	45 × 52,5	B263-41400-026V1	
	63	22	18,5	45 × 72	H406-41400-126V1*	
	80	30	22	45 × 72	H408-41400-126V1	
	100	37	30	45 × 72	H410-41400-126V1	
125	45	37	45 × 72	H412-41400-126V1		

* größerer Anschlussquerschnitt, siehe Seite 154

Weitere Schaltprogramme ab Seite 132.

Lasttrennschalter

Hauptschalter Bodeneinbau Schnappbefestigung für Installationsverteiler

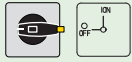
Schaltprogramm	Bemessungsdaten (IEC 60947) Betriebsstrom I_e Betriebsleistung (bei 380–440 V)			Frontschildmaß für Normausschnitt 45 mm (H × B) (mm)	Griffverriegelung V-Griff grau/schwarz  IP30	Bestellnummer
	AC-21A (A)	AC-23A (kW)	AC-3 (kW)			
41600 – 6-polig – ohne Hilfskontakte 	20	5,5	3,7	45 × 76		H216-41600-026V1
	25	7,5	5,5	45 × 76		H220-41600-026V1
	32	11	7,5	45 × 76		H226-41600-026V1
	40	15	11	45 × 76		H233-41600-026V1
	40	15	11	45 × 105		B240-41600-026V1*
	50	18,5	15	45 × 105		B250-41600-026V1
	63	22	18,5	45 × 105		B263-41600-026V1
	63	22	18,5	45 × 72		H406-41600-126V1*
	80	30	22	45 × 72		H408-41600-126V1
	100	37	30	45 × 72		H410-41600-126V1
	125	45	37	45 × 72		H412-41600-126V1

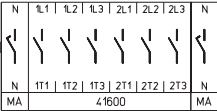
41800 – 8-polig – ohne Hilfskontakte – 2 Neutralleiter voreilend 	20	5,5	3,7	45 × 76		H216-41800-026V1
	25	7,5	5,5	45 × 76		H220-41800-026V1
	32	11	7,5	45 × 76		H226-41800-026V1
	40	15	11	45 × 76		H233-41800-026V1
	40	15	11	45 × 105		B240-41800-026V1*
	50	18,5	15	45 × 105		B250-41800-026V1
	63	22	18,5	45 × 105		B263-41800-026V1
	63	22	18,5	45 × 72		H406-41800-126V1*
	80	30	22	45 × 72		H408-41800-126V1
	100	37	30	45 × 72		H410-41800-126V1
	125	45	37	45 × 72		H412-41800-126V1

* größerer Anschlussquerschnitt, siehe Seite 154
Weitere Schaltprogramme ab Seite 132.

Abmessungen in mm:

Aufbau der Bestellnummer		
Typ	Schaltprogramm	Bauform
H216	41300	026V1
Best.-Nr.	H216-41300-026V1	

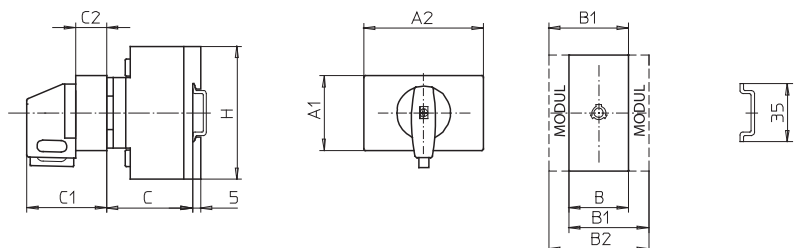

Schaltprogramme 3- und 4-polig

Typen H216 / H220 / H226 / H233:

Bauform	A1	A2	B	B1	B2	C	C1	C2	H
026V1	45	48	36	48	60	38	45	18,5	70
126V1	45	60	36	48	60	38	45	18,5	70

Typen B240 / B250 / B263:

Bauform	A1	A2	B	B1	B2	C	C1	C2	H
026V1	45	52,5	50	69	88	38	45	18,5	72

Typen H406 / H408 / H410 / H412:

Bauform	A1	A2	B	B1	B2	C	C1	C2	H
126V1	45	72	70	89	108	55	48	16	80

Schaltprogramme 6- und 8-polig

Typen H216 / H220 / H226 / H233:

Bauform	A1	A2	B	B1	B2	C	C1	C2	H
026V1	45	76	72	84	96	40	51,5	25,5	70

Typen B240 / B250 / B263:

Bauform	A1	A2	B	B1	B2	C	C1	C2	H
026V1	45	105	100	119	138	40	51,5	25,5	72

Typen H406 / H408 / H410 / H412:

Bauform	A1	A2	B	B1	B2	C	C1	C2	H
126V1	45	72	140	159	178	67	48	16	80

Hauptschalter

- Bodeneinbauswitcher mit Schnappbefestigung
- Türverriegelung
- 3- bis 8-polig
- 20 A bis 125 A
- **IP66**
- mit Modular- bzw. Metallachsverlängerung
- Zentral- oder Vierlochbefestigung frontseitig



Bodeneinbauswitcher mit Schnappbefestigung und Türverriegelung werden in zwei Verlängerungsvarianten angeboten:

1. Schalter mit **Modularachsverlängerung** können durch das Aufstecken zusätzlicher Module auf das benötigte Einbaumaß C verlängert werden. Die zugehörigen Verlängerungsbauteile finden Sie auf Seite 145.

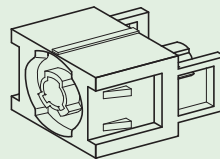
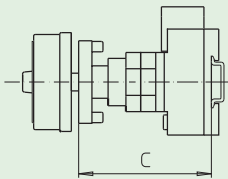

AVC2/AVC4
Modularachsverlängerung

2. Bei Schaltern mit **Metallachsverlängerung** ist die benötigte Metallachse nicht im Lieferumfang enthalten und muss getrennt bestellt werden. Angaben zum Einbaumaß C und zu den erhältlichen Ausführungen finden Sie auf Seite 146.

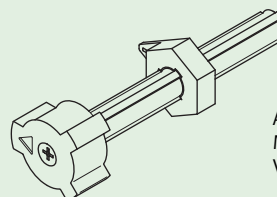
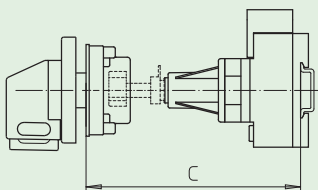



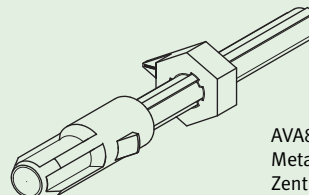
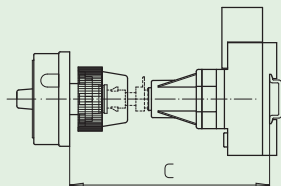



AVB8
Metallachsverlängerung für
Vierlochbefestigung (frontseitig)



AVA8
Metallachsverlängerung für
Zentralbefestigung (frontseitig)

Lasttrennschalter

Hauptschalter Bodeneinbau Schnappbefestigung mit Türverriegelung

Schaltprogramm	Bemessungsdaten (IEC 60947) Betriebsstrom I _e Betriebsleistung (bei 380–440 V)			Befestigungsmaß (frontseitig) (mm)	Vorhängeschlossperre N-Griff schwarz	Vorhängeschlossperre M-Griff schwarz	Griffverriegelung V-Griff silber/schwarz
	AC-21A (A)	AC-23A (kW)	AC-3 (kW)		 	 	 
					IP66	IP66	IP66
					Bestellnummer	Bestellnummer	Bestellnummer

41300
– 3-polig
– ohne Hilfskontakte

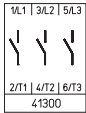

mit Modularachsverlängerung:

→ Verlängerungsbauteile siehe Seite 145!

20	5,5	3,7	36 x 36	H216-41300-234N1	H216-41300-234M1	H216-41300-234V1
20	5,5	3,7	48 x 48	H216-41300-238N1	H216-41300-238M1	H216-41300-238V1
25	7,5	5,5	36 x 36	H220-41300-234N1	H220-41300-234M1	H220-41300-234V1
25	7,5	5,5	48 x 48	H220-41300-238N1	H220-41300-238M1	H220-41300-238V1
32	11	7,5	36 x 36	H226-41300-234N1	H226-41300-234M1	H226-41300-234V1
32	11	7,5	48 x 48	H226-41300-238N1	H226-41300-238M1	H226-41300-238V1
40	15	11	36 x 36	H233-41300-234N1	H233-41300-234M1	H233-41300-234V1
40	15	11	36 x 36	B240-41300-234N1*	B240-41300-234M1*	B240-41300-234V1*
40	15	11	48 x 48	H233-41300-238N1	H233-41300-238M1	H233-41300-238V1
40	15	11	48 x 48	B240-41300-238N1*	B240-41300-238M1*	B240-41300-238V1*
50	18,5	15	36 x 36	B250-41300-234N1	B250-41300-234M1	B250-41300-234V1
50	18,5	15	48 x 48	B250-41300-238N1	B250-41300-238M1	B250-41300-238V1
63	22	18,5	36 x 36	B263-41300-234N1	B263-41300-234M1	B263-41300-234V1
63	22	18,5	48 x 48	B263-41300-238N1	B263-41300-238M1	B263-41300-238V1
63	22	18,5	48 x 48	H406-41300-234N1*	H406-41300-234M1*	H406-41300-234V1*
80	30	22	48 x 48	H408-41300-234N1	H408-41300-234M1	H408-41300-234V1
100	37	30	48 x 48	H410-41300-234N1	H410-41300-234M1	H410-41300-234V1
125	45	37	48 x 48	H412-41300-234N1	H412-41300-234M1	H412-41300-234V1



mit Metallachsverlängerung:

→ Zugehörige Metallachse getrennt bestellen, siehe Seite 146!

20	5,5	3,7	36 x 36	H216-41300-483N1	H216-41300-483M1	H216-41300-483V1
20	5,5	3,7	48 x 48	H216-41300-484N1	H216-41300-484M1	H216-41300-484V1
20	5,5	3,7	Ø 22,5	H216-41300-281N1	H216-41300-281M1	H216-41300-281V1
25	7,5	5,5	36 x 36	H220-41300-483N1	H220-41300-483M1	H220-41300-483V1
25	7,5	5,5	48 x 48	H220-41300-484N1	H220-41300-484M1	H220-41300-484V1
25	7,5	5,5	Ø 22,5	H220-41300-281N1	H220-41300-281M1	H220-41300-281V1
32	11	7,5	36 x 36	H226-41300-483N1	H226-41300-483M1	H226-41300-483V1
32	11	7,5	48 x 48	H226-41300-484N1	H226-41300-484M1	H226-41300-484V1
32	11	7,5	Ø 22,5	H226-41300-281N1	H226-41300-281M1	H226-41300-281V1
40	15	11	36 x 36	H233-41300-483N1	H233-41300-483M1	H233-41300-483V1
40	15	11	36 x 36	B240-41300-483N1*	B240-41300-483M1*	B240-41300-483V1*
40	15	11	48 x 48	H233-41300-484N1	H233-41300-484M1	H233-41300-484V1
40	15	11	48 x 48	B240-41300-484N1*	B240-41300-484M1*	B240-41300-484V1*
40	15	11	Ø 22,5	H233-41300-281N1	H233-41300-281M1	H233-41300-281V1
40	15	11	Ø 22,5	B240-41300-281N1*	B240-41300-281M1*	B240-41300-281V1*
50	18,5	15	36 x 36	B250-41300-483N1	B250-41300-483M1	B250-41300-483V1
50	18,5	15	48 x 48	B250-41300-484N1	B250-41300-484M1	B250-41300-484V1
50	18,5	15	Ø 22,5	B250-41300-281N1	B250-41300-281M1	B250-41300-281V1
63	22	18,5	36 x 36	B263-41300-483N1	B263-41300-483M1	B263-41300-483V1
63	22	18,5	48 x 48	B263-41300-484N1	B263-41300-484M1	B263-41300-484V1
63	22	18,5	48 x 48	H406-41300-483N1*	H406-41300-483M1*	H406-41300-483V1*
63	22	18,5	Ø 22,5	B263-41300-281N1	B263-41300-281M1	B263-41300-281V1
63	22	18,5	Ø 22,5	H406-41300-281N1*	H406-41300-281M1*	H406-41300-281V1*
80	30	22	48 x 48	H408-41300-483N1	H408-41300-483M1	H408-41300-483V1
80	30	22	Ø 22,5	H408-41300-281N1	H408-41300-281M1	H408-41300-281V1
100	37	30	48 x 48	H410-41300-483N1	H410-41300-483M1	H410-41300-483V1
100	37	30	Ø 22,5	H410-41300-281N1	H410-41300-281M1	H410-41300-281V1
125	45	37	48 x 48	H412-41300-483N1	H412-41300-483M1	H412-41300-483V1
125	45	37	Ø 22,5	H412-41300-281N1	H412-41300-281M1	H412-41300-281V1

* größerer Anschlussquerschnitt, s. Seite 154

Weitere Schaltprogramme ab Seite 132.

Schaltprogramm	Bemessungsdaten (IEC 60947) Betriebsstrom I _e Betriebsleistung (bei 380–440 V)			Befestigungsmaß (frontseitig) (mm)	Vorhängeschlossperre N-Griff schwarz	Vorhängeschlossperre M-Griff schwarz	Griffverriegelung V-Griff silber/schwarz
	AC-21A (A)	AC-23A (kW)	AC-3 (kW)		 OFF ON IP66	 OFF ON IP66	 OFF ON IP66
					Bestellnummer	Bestellnummer	Bestellnummer

41400

- 4-polig
- ohne Hilfskontakte
- Neutralleiter voreilend

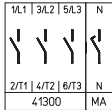

mit Modularachsverlängerung:

→ Verlängerungsbauteile siehe Seite 145!

20	5,5	3,7	36 × 36	H216-41400-234N1	H216-41400-234M1	H216-41400-234V1
20	5,5	3,7	48 × 48	H216-41400-238N1	H216-41400-238M1	H216-41400-238V1
25	7,5	5,5	36 × 36	H220-41400-234N1	H220-41400-234M1	H220-41400-234V1
25	7,5	5,5	48 × 48	H220-41400-238N1	H220-41400-238M1	H220-41400-238V1
32	11	7,5	36 × 36	H226-41400-234N1	H226-41400-234M1	H226-41400-234V1
32	11	7,5	48 × 48	H226-41400-238N1	H226-41400-238M1	H226-41400-238V1
40	15	11	36 × 36	H233-41400-234N1	H233-41400-234M1	H233-41400-234V1
40	15	11	36 × 36	B240-41400-234N1*	B240-41400-234M1*	B240-41400-234V1*
40	15	11	48 × 48	H233-41400-238N1	H233-41400-238M1	H233-41400-238V1
40	15	11	48 × 48	B240-41400-238N1*	B240-41400-238M1*	B240-41400-238V1*
50	18,5	15	36 × 36	B250-41400-234N1	B250-41400-234M1	B250-41400-234V1
50	18,5	15	48 × 48	B250-41400-238N1	B250-41400-238M1	B250-41400-238V1
63	22	18,5	36 × 36	B263-41400-234N1	B263-41400-234M1	B263-41400-234V1
63	22	18,5	48 × 48	B263-41400-238N1	B263-41400-238M1	B263-41400-238V1
63	22	18,5	48 × 48	H406-41400-234N1*	H406-41400-234M1*	H406-41400-234V1*
80	30	22	48 × 48	H408-41400-234N1	H408-41400-234M1	H408-41400-234V1
100	37	30	48 × 48	H410-41400-234N1	H410-41400-234M1	H410-41400-234V1
125	45	37	48 × 48	H412-41400-234N1	H412-41400-234M1	H412-41400-234V1

mit Metallachsverlängerung:

→ Zugehörige Metallachse getrennt bestellen, siehe Seite 146!

20	5,5	3,7	36 × 36	H216-41400-483N1	H216-41400-483M1	H216-41400-483V1
20	5,5	3,7	48 × 48	H216-41400-484N1	H216-41400-484M1	H216-41400-484V1
20	5,5	3,7	∅ 22,5	H216-41400-281N1	H216-41400-281M1	H216-41400-281V1
25	7,5	5,5	36 × 36	H220-41400-483N1	H220-41400-483M1	H220-41400-483V1
25	7,5	5,5	48 × 48	H220-41400-484N1	H220-41400-484M1	H220-41400-484V1
25	7,5	5,5	∅ 22,5	H220-41400-281N1	H220-41400-281M1	H220-41400-281V1
32	11	7,5	36 × 36	H226-41400-483N1	H226-41400-483M1	H226-41400-483V1
32	11	7,5	48 × 48	H226-41400-484N1	H226-41400-484M1	H226-41400-484V1
32	11	7,5	∅ 22,5	H226-41400-281N1	H226-41400-281M1	H226-41400-281V1
40	15	11	36 × 36	H233-41400-483N1	H233-41400-483M1	H233-41400-483V1
40	15	11	36 × 36	B240-41400-483N1*	B240-41400-483M1*	B240-41400-483V1*
40	15	11	48 × 48	H233-41400-484N1	H233-41400-484M1	H233-41400-484V1
40	15	11	48 × 48	B240-41400-484N1*	B240-41400-484M1*	B240-41400-484V1*
40	15	11	∅ 22,5	H233-41400-281N1	H233-41400-281M1	H233-41400-281V1
40	15	11	∅ 22,5	B240-41400-281N1*	B240-41400-281M1*	B240-41400-281V1*
50	18,5	15	36 × 36	B250-41400-483N1	B250-41400-483M1	B250-41400-483V1
50	18,5	15	48 × 48	B250-41400-484N1	B250-41400-484M1	B250-41400-484V1
50	18,5	15	∅ 22,5	B250-41400-281N1	B250-41400-281M1	B250-41400-281V1
63	22	18,5	36 × 36	B263-41400-483N1	B263-41400-483M1	B263-41400-483V1
63	22	18,5	48 × 48	B263-41400-484N1	B263-41400-484M1	B263-41400-484V1
63	22	18,5	48 × 48	H406-41400-483N1*	H406-41400-483M1*	H406-41400-483V1*
63	22	18,5	∅ 22,5	B263-41400-281N1	B263-41400-281M1	B263-41400-281V1
63	22	18,5	∅ 22,5	H406-41400-281N1*	H406-41400-281M1*	H406-41400-281V1*
80	30	22	48 × 48	H408-41400-483N1	H408-41400-483M1	H408-41400-483V1
80	30	22	∅ 22,5	H408-41400-281N1	H408-41400-281M1	H408-41400-281V1
100	37	30	48 × 48	H410-41400-483N1	H410-41400-483M1	H410-41400-483V1
100	37	30	∅ 22,5	H410-41400-281N1	H410-41400-281M1	H410-41400-281V1
125	45	37	48 × 48	H412-41400-483N1	H412-41400-483M1	H412-41400-483V1
125	45	37	∅ 22,5	H412-41400-281N1	H412-41400-281M1	H412-41400-281V1

* größerer Anschlussquerschnitt, s. Seite 154

Weitere Schaltprogramme ab Seite 132.

Lasttrennschalter

Hauptschalter Bodeneinbau Schnappbefestigung mit Türverriegelung

Schaltprogramm	Bemessungsdaten (IEC 60947) Betriebsstrom I_e Betriebsleistung (bei 380–440 V)			Befestigungsmaß (frontseitig) (mm)	Vorhängeschlossperre N-Griff schwarz	Vorhängeschlossperre M-Griff schwarz	Griffverriegelung V-Griff silber/schwarz
	AC-21A (A)	AC-23A (kW)	AC-3 (kW)				
					Bestellnummer	Bestellnummer	Bestellnummer

41600
– 6-polig
– ohne Hilfskontakte

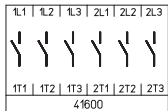

mit Modularachsverlängerung:

→ Verlängerungsbauteile siehe Seite 145!

20	5,5	3,7	36 x 36	H216-41600-234N1	H216-41600-234M1	–
20	5,5	3,7	48 x 48	H216-41600-238N1	H216-41600-238M1	H216-41600-238V1
25	7,5	5,5	36 x 36	H220-41600-234N1	H220-41600-234M1	–
25	7,5	5,5	48 x 48	H220-41600-238N1	H220-41600-238M1	H220-41600-238V1
32	11	7,5	36 x 36	H226-41600-234N1	H226-41600-234M1	–
32	11	7,5	48 x 48	H226-41600-238N1	H226-41600-238M1	H226-41600-238V1
40	15	11	36 x 36	H233-41600-234N1	H233-41600-234M1	–
40	15	11	36 x 36	B240-41600-234N1*	B240-41600-234M1*	–
40	15	11	48 x 48	H233-41600-238N1	H233-41600-238M1	H233-41600-238V1
40	15	11	48 x 48	B240-41600-238N1*	B240-41600-238M1*	B240-41600-238V1*
50	18,5	15	36 x 36	B250-41600-234N1	B250-41600-234M1	–
50	18,5	15	48 x 48	B250-41600-238N1	B250-41600-238M1	B250-41600-238V1
63	22	18,5	36 x 36	B263-41600-234N1	B263-41600-234M1	–
63	22	18,5	48 x 48	B263-41600-238N1	B263-41600-238M1	B263-41600-238V1
63	22	18,5	48 x 48	H406-41600-234N1*	H406-41600-234M1*	H406-41600-234V1*
80	30	22	48 x 48	H408-41600-234N1	H408-41600-234M1	H408-41600-234V1
100	37	30	48 x 48	H410-41600-234N1	H410-41600-234M1	H410-41600-234V1
125	45	37	48 x 48	H412-41600-234N1	H412-41600-234M1	H412-41600-234V1

mit Metallachsverlängerung:

→ Zugehörige Metallachse getrennt bestellen, siehe Seite 146!

20	5,5	3,7	36 x 36	H216-41600-483N1	H216-41600-483M1	–
20	5,5	3,7	48 x 48	H216-41600-484N1	H216-41600-484M1	H216-41600-484V1
20	5,5	3,7	Ø 22,5	H216-41600-281N1	H216-41600-281M1	–
25	7,5	5,5	36 x 36	H220-41600-483N1	H220-41600-483M1	–
25	7,5	5,5	48 x 48	H220-41600-484N1	H220-41600-484M1	H220-41600-484V1
25	7,5	5,5	Ø 22,5	H220-41600-281N1	H220-41600-281M1	–
32	11	7,5	36 x 36	H226-41600-483N1	H226-41600-483M1	–
32	11	7,5	48 x 48	H226-41600-484N1	H226-41600-484M1	H226-41600-484V1
32	11	7,5	Ø 22,5	H226-41600-281N1	H226-41600-281M1	–
40	15	11	36 x 36	H233-41600-483N1	H233-41600-483M1	–
40	15	11	36 x 36	B240-41600-483N1*	B240-41600-483M1*	–
40	15	11	48 x 48	H233-41600-484N1	H233-41600-484M1	H233-41600-484V1
40	15	11	48 x 48	B240-41600-484N1*	B240-41600-484M1*	B240-41600-484V1*
40	15	11	Ø 22,5	H233-41600-281N1	H233-41600-281M1	–
40	15	11	Ø 22,5	B240-41600-281N1*	B240-41600-281M1*	–
50	18,5	15	36 x 36	B250-41600-483N1	B250-41600-483M1	–
50	18,5	15	48 x 48	B250-41600-484N1	B250-41600-484M1	B250-41600-484V1
50	18,5	15	Ø 22,5	B250-41600-281N1	B250-41600-281M1	–
63	22	18,5	36 x 36	B263-41600-483N1	B263-41600-483M1	–
63	22	18,5	48 x 48	B263-41600-484N1	B263-41600-484M1	B263-41600-484V1
63	22	18,5	48 x 48	H406-41600-483N1*	H406-41600-483M1*	H406-41600-483V1*
63	22	18,5	Ø 22,5	B263-41600-281N1	B263-41600-281M1	–
63	22	18,5	Ø 22,5	H406-41600-281N1*	H406-41600-281M1*	H406-41600-281V1
80	30	22	48 x 48	H408-41600-483N1	H408-41600-483M1	H408-41600-483V1
80	30	22	Ø 22,5	H408-41600-281N1	H408-41600-281M1	H408-41600-281V1
100	37	30	48 x 48	H410-41600-483N1	H410-41600-483M1	H410-41600-483V1
100	37	30	Ø 22,5	H410-41600-281N1	H410-41600-281M1	H410-41600-281V1
125	45	37	48 x 48	H412-41600-483N1	H412-41600-483M1	H412-41600-483V1
125	45	37	Ø 22,5	H412-41600-281N1	H412-41600-281M1	H412-41600-281V1

* größerer Anschlussquerschnitt, s. Seite 154

Weitere Schaltprogramme ab Seite 132.

Schaltprogramm	Bemessungsdaten (IEC 60947) Betriebsstrom I _e Betriebsleistung (bei 380–440 V)			Befestigungsmaß (frontseitig) (mm)	Vorhängeschlossperre N-Griff schwarz	Vorhängeschlossperre M-Griff schwarz	Griffverriegelung V-Griff silber/schwarz
	AC-21A (A)	AC-23A (kW)	AC-3 (kW)				
					Bestellnummer	Bestellnummer	Bestellnummer

41800

- 8-polig
- ohne Hilfskontakte
- 2 Neutralleiter voreilend

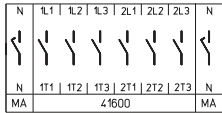

mit Modularachsverlängerung:

→ Verlängerungsbauteile siehe Seite 145!

20	5,5	3,7	36 x 36	H216-41800-234N1	H216-41800-234M1	–
20	5,5	3,7	48 x 48	H216-41800-238N1	H216-41800-238M1	H216-41800-238V1
25	7,5	5,5	36 x 36	H220-41800-234N1	H220-41800-234M1	–
25	7,5	5,5	48 x 48	H220-41800-238N1	H220-41800-238M1	H220-41800-238V1
32	11	7,5	36 x 36	H226-41800-234N1	H226-41800-234M1	–
32	11	7,5	48 x 48	H226-41800-238N1	H226-41800-238M1	H226-41800-238V1
40	15	11	36 x 36	H233-41800-234N1	H233-41800-234M1	–
40	15	11	36 x 36	B240-41800-234N1*	B240-41800-234M1*	–
40	15	11	48 x 48	H233-41800-238N1	H233-41800-238M1	H233-41800-238V1
40	15	11	48 x 48	B240-41800-238N1*	B240-41800-238M1*	B240-41800-238V1*
50	18,5	15	36 x 36	B250-41800-234N1	B250-41800-234M1	–
50	18,5	15	48 x 48	B250-41800-238N1	B250-41800-238M1	B250-41800-238V1
63	22	18,5	36 x 36	B263-41800-234N1	B263-41800-234M1	–
63	22	18,5	48 x 48	B263-41800-238N1	B263-41800-238M1	B263-41800-238V1
63	22	18,5	48 x 48	H406-41800-234N1*	H406-41800-234M1*	H406-41800-234V1*
80	30	22	48 x 48	H408-41800-234N1	H408-41800-234M1	H408-41800-234V1
100	37	30	48 x 48	H410-41800-234N1	H410-41800-234M1	H410-41800-234V1
125	45	37	48 x 48	H412-41800-234N1	H412-41800-234M1	H412-41800-234V1

mit Metallachsverlängerung:

→ Zugehörige Metallachse getrennt bestellen, siehe Seite 146!

20	5,5	3,7	36 x 36	H216-41800-483N1	H216-41800-483M1	–
20	5,5	3,7	48 x 48	H216-41800-484N1	H216-41800-484M1	H216-41800-484V1
20	5,5	3,7	∅ 22,5	H216-41800-281N1	H216-41800-281M1	–
25	7,5	5,5	36 x 36	H220-41800-483N1	H220-41800-483M1	–
25	7,5	5,5	48 x 48	H220-41800-484N1	H220-41800-484M1	H220-41800-484V1
25	7,5	5,5	∅ 22,5	H220-41800-281N1	H220-41800-281M1	–
32	11	7,5	36 x 36	H226-41800-483N1	H226-41800-483M1	–
32	11	7,5	48 x 48	H226-41800-484N1	H226-41800-484M1	H226-41800-484V1
32	11	7,5	∅ 22,5	H226-41800-281N1	H226-41800-281M1	–
40	15	11	36 x 36	H233-41800-483N1	H233-41800-483M1	–
40	15	11	36 x 36	B240-41800-483N1*	B240-41800-483M1*	–
40	15	11	48 x 48	H233-41800-484N1	H233-41800-484M1	H233-41800-484V1
40	15	11	48 x 48	B240-41800-484N1*	B240-41800-484M1*	B240-41800-484V1*
40	15	11	∅ 22,5	H233-41800-281N1	H233-41800-281M1	–
40	15	11	∅ 22,5	B240-41800-281N1*	B240-41800-281M1*	–
50	18,5	15	36 x 36	B250-41800-483N1	B250-41800-483M1	–
50	18,5	15	48 x 48	B250-41800-484N1	B250-41800-484M1	B250-41800-484V1
50	18,5	15	∅ 22,5	B250-41800-281N1	B250-41800-281M1	–
63	22	18,5	36 x 36	B263-41800-483N1	B263-41800-483M1	–
63	22	18,5	48 x 48	B263-41800-484N1	B263-41800-484M1	B263-41800-484V1
63	22	18,5	48 x 48	H406-41800-483N1*	H406-41800-483M1*	H406-41800-483V1*
63	22	18,5	∅ 22,5	B263-41800-281N1	B263-41800-281M1	–
63	22	18,5	∅ 22,5	H406-41800-281N1*	H406-41800-281M1*	H406-41800-281V1
80	30	22	48 x 48	H408-41800-483N1	H408-41800-483M1	H408-41800-483V1
80	30	22	∅ 22,5	H408-41800-281N1	H408-41800-281M1	H408-41800-281V1
100	37	30	48 x 48	H410-41800-483N1	H410-41800-483M1	H410-41800-483V1
100	37	30	∅ 22,5	H410-41800-281N1	H410-41800-281M1	H410-41800-281V1
125	45	37	48 x 48	H412-41800-483N1	H412-41800-483M1	H412-41800-483V1
125	45	37	∅ 22,5	H412-41800-281N1	H412-41800-281M1	H412-41800-281V1

* größerer Anschlussquerschnitt, s. Seite 154

Weitere Schaltprogramme ab Seite 132.

Lasttrennschalter

Hauptschalter Bodeneinbau Schnappbefestigung mit Türverriegelung

Abmessungen in mm:

Türverriegelung mit **Modularachsverlängerung**: Vierlochbefestigung (frontseitig)

Aufbau der Bestellnummer		
Typ	Schaltprogramm	Bauform
H233	41400	234N1
Best.-Nr. H233-41400-234N1		

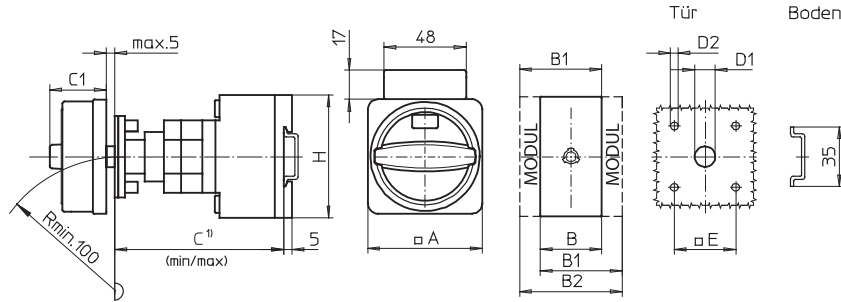

¹⁾ Einbaumaß: Innenseite Tür bis Oberkante Tragschiene, Abmessungen mit Verlängerung siehe Seite 145.

Schaltprogramme 3- und 4-polig

Typen H216 / H220 / H226 / H233:

Bauform	A	B	B1	B2	C _{min}	C _{max}	C1	D1	D2	E	H
234M1	67	36	48	60	92	107	38	15	4,5	36	70
234N1	67	36	48	60	92	107	33	15	4,5	36	70
234V1	48	36	48	60	92	107	32	12	4,5	36	70
238M1	67	36	48	60	92	107	38	15	5	48	70
238N1	67	36	48	60	92	107	33	15	5	48	70
238V1	64	36	48	60	92	107	39	15	5	48	70

Schaltprogramme 6- und 8-polig

Typen H216 / H220 / H226 / H233:

Bauform	A	B	B1	B2	C _{min}	C _{max}	C1	D1	D2	E	H
234M1	67	72	84	96	100	115	38	15	4,5	36	70
234N1	67	72	84	96	100	115	33	15	4,5	36	70
238M1	67	72	84	96	100	115	38	15	5	48	70
238N1	67	72	84	96	100	115	33	15	5	48	70
238V1	64	72	84	96	100	115	39	15	5	48	70

Typen B240 / B250 / B263:

Bauform	A	B	B1	B2	C _{min}	C _{max}	C1	D1	D2	E	H
234M1	67	50	69	88	92	107	38	15	4,5	36	72
234N1	67	50	69	88	92	107	33	15	4,5	36	72
234V1	48	50	69	88	92	107	32	12	4,5	36	72
238M1	67	50	69	88	92	107	38	15	5	48	72
238N1	67	50	69	88	92	107	33	15	5	48	72
238V1	64	50	69	88	92	107	39	15	5	48	72

Typen B240 / B250 / B263:

Bauform	A	B	B1	B2	C _{min}	C _{max}	C1	D1	D2	E	H
234M1	67	100	119	138	104	119	38	15	4,5	36	72
234N1	67	100	119	138	104	119	33	15	4,5	36	72
238M1	67	100	119	138	104	119	38	15	5	48	72
238N1	67	100	119	138	104	119	33	15	5	48	72
238V1	64	100	119	138	104	119	39	15	5	48	72

Typen H406 / H408 / H410 / H412:

Bauform	A	B	B1	B2	C _{min}	C _{max}	C1	D1	D2	E	H
234M1	88	70	89	108	102	117	50	15	5	48	80
234N1	88	70	89	108	102	117	45	15	5	48	80
234V1	64	70	89	108	102	117	40	15	5	48	80

Typen H406 / H408 / H410 / H412:

Bauform	A	B	B1	B2	C _{min}	C _{max}	C1	D1	D2	E	H
234M1	88	140	159	178	115	130	50	15	5	48	80
234N1	88	140	159	178	115	130	45	15	5	48	80
234V1	64	140	159	178	115	130	40	15	5	48	80

Abmessungen in mm:

Türverriegelung mit **Metallachsverlängerung**: Vierlochbefestigung (frontseitig)

Aufbau der Bestellnummer		
Typ	Schaltprogramm	Bauform
H406	41800	483N1
Best.-Nr. H406-41800-483N1		

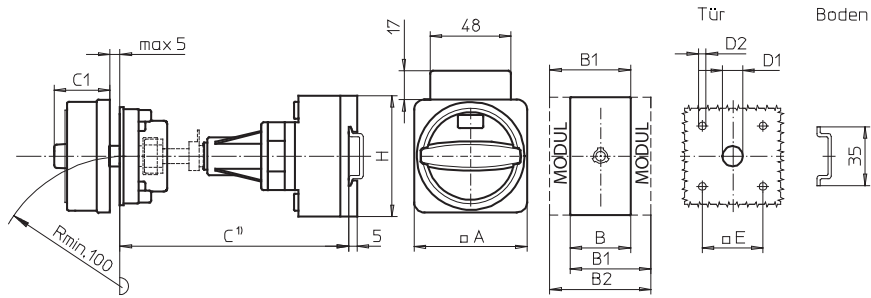

¹⁾ Einbaumaß: Innenseite Tür bis Oberkante Tragschiene, Abmessungen siehe Seite 146.

Schaltprogramme 3- und 4-polig

Typen H216 / H220 / H226 / H233:

Bauform	A	B	B1	B2	C1	D1	D2	E	H
483M1	67	36	48	60	38	15	4,5	36	70
483N1	67	36	48	60	33	15	4,5	36	70
483V1	48	36	48	60	32	15	4,5	36	70
484M1	67	36	48	60	38	15	5	48	70
484N1	67	36	48	60	33	15	5	48	70
484V1	64	36	48	60	39	15	5	48	70

Schaltprogramme 6- und 8-polig

Typen H216 / H220 / H226 / H233:

Bauform	A	B	B1	B2	C1	D1	D2	E	H
483M1	67	72	84	96	38	15	4,5	36	70
483N1	67	72	84	96	33	15	4,5	36	70
484M1	67	72	84	96	38	15	5	48	70
484N1	67	72	84	96	33	15	5	48	70
484V1	64	72	84	96	39	15	5	48	70

Typen B240 / B250 / B263:

Bauform	A	B	B1	B2	C1	D1	D2	E	H
483M1	67	50	69	88	38	15	4,5	36	72
483N1	67	50	69	88	33	15	4,5	36	72
483V1	48	50	69	88	32	15	4,5	36	72
484M1	67	50	69	88	38	15	5	48	72
484N1	67	50	69	88	33	15	5	48	72
484V1	64	50	69	88	39	15	5	48	72

Typen B240 / B250 / B263:

Bauform	A	B	B1	B2	C1	D1	D2	E	H
483M1	67	100	119	138	38	15	4,5	36	72
483N1	67	100	119	138	33	15	4,5	36	72
484M1	67	100	119	138	38	15	5	48	72
484N1	67	100	119	138	33	15	5	48	72
484V1	64	100	119	138	39	15	5	48	72

Typen H406 / H408 / H410 / H412:

Bauform	A	B	B1	B2	C1	D1	D2	E	H
483M1	88	70	89	108	50	15	5	48	80
483N1	88	70	89	108	45	15	5	48	80
483V1	64	70	89	108	40	15	5	48	80

Typen H406 / H408 / H410 / H412:

Bauform	A	B	B1	B2	C1	D1	D2	E	H
483M1	88	140	159	178	50	15	5	48	80
483N1	88	140	159	178	45	15	5	48	80
483V1	64	140	159	178	40	15	5	48	80

Lasttrennschalter

Hauptschalter **Bodeneinbau** Schnappbefestigung mit Türverriegelung

Abmessungen in mm:

Türverriegelung mit **Metallachsverlängerung**: Zentralbefestigung (frontseitig)

Aufbau der Bestellnummer		
Typ	Schaltprogramm	Bauform
H233	41400	281N1
Best.-Nr.	H233-41400-281N1	

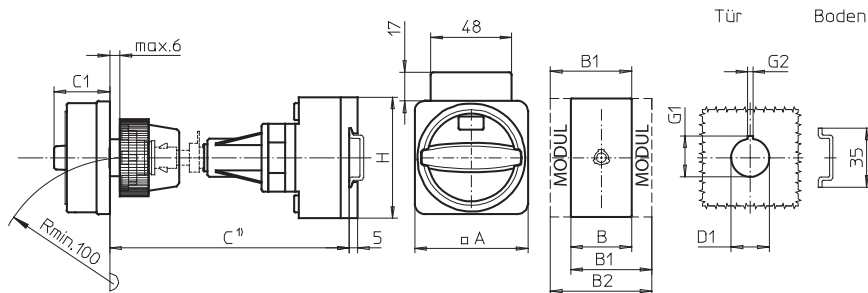

¹⁾ Einbaumaß: Außenseite Tür bis Oberkante Tragschiene, Abmessungen siehe Seite 146.

Schaltprogramme 3- und 4-polig

Typen H216 / H220 / H226 / H233:

Bauform	A	B	B1	B2	C1	D1	G1	G2	H
281M1	67	36	48	60	38	22,5	24,2	3,2	70
281N1	67	36	48	60	33	22,5	24,2	3,2	70
281V1	48	36	48	60	32	22,5	24,2	3,2	70

Typen B240 / B250 / B263:

Bauform	A	B	B1	B2	C1	D1	G1	G2	H
281M1	67	50	69	88	38	22,5	24,2	3,2	72
281N1	67	50	69	88	33	22,5	24,2	3,2	72
281V1	48	50	69	88	32	22,5	24,2	3,2	72

Typen H406 / H408 / H410 / H412:

Bauform	A	B	B1	B2	C1	D1	G1	G2	H
281M1	67	70	89	108	38	22,5	24,2	3,2	80
281N1	67	70	89	108	33	22,5	24,2	3,2	80
281V1	64	70	89	108	39	22,5	24,2	3,2	80

Schaltprogramme 6- und 8-polig

Typen H216 / H220 / H226 / H233:

Bauform	A	B	B1	B2	C1	D1	G1	G2	H
281M1	67	72	84	96	38	22,5	24,2	3,2	70
281N1	67	72	84	96	33	22,5	24,2	3,2	70

Typen B240 / B250 / B263:

Bauform	A	B	B1	B2	C1	D1	G1	G2	H
281M1	67	100	119	138	38	22,5	24,2	3,2	72
281N1	67	100	119	138	33	22,5	24,2	3,2	72







Typen H406 / H408 / H410 / H412:

Bauform	A	B	B1	B2	C1	D1	G1	G2	H
281M1	67	140	159	178	38	22,5	24,2	3,2	80
281N1	67	140	159	178	33	22,5	24,2	3,2	80
281V1	64	140	159	178	39	22,5	24,2	3,2	80

Hauptschalter

- Bodeneinbauschalter mit Vierlochbefestigung
- Türverriegelung
- 3- bis 8-polig
- 160 A bis 315 A
- IP55



Schaltprogramm	Bemessungsdaten (IEC 60947) Betriebs- Betriebsleistung strom I _e (bei 380–440 V)			Befestigungsmaß (boden-/frontseitig) (mm)	Vorhängeschlossperre N-Griff schwarz	Vorhängeschlossperre M-Griff schwarz	Vorhängeschlossperre H-Griff silber/schwarz
	AC-21A (A)	AC-23A (kW)	AC-3 (kW)		  IP55	  IP55	  IP55
					Bestellnummer	Bestellnummer	Bestellnummer
41300 – 3-polig – ohne Hilfskontakte	160	75	45	68 × 68 / 68 × 68	K616-41300-034N1	K616-41300-034M1	K616-41300-034H1
	315	132	55	104 × 104 / 104 × 104	–	–	K830-41300-034H1



41400 – 4-polig – ohne Hilfskontakte – Neutralleiter voreilend	160	75	45	68 × 68 / 68 × 68	K616-41400-034N1	K616-41400-034M1	K616-41400-034H1
	315	132	55	104 × 104 / 104 × 104	–	–	K830-41400-034H1

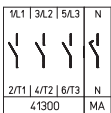

41600 – 6-polig – ohne Hilfskontakte	160	75	45	68 × 68 / 68 × 68	K616-41600-034N1	K616-41600-034M1	K616-41600-034H1
	315	132	55	104 × 104 / 104 × 104	–	–	K830-41600-034H1

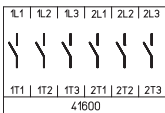

41800 – 8-polig – ohne Hilfskontakte – 2 Neutralleiter voreilend	160	75	45	68 × 68 / 68 × 68	K616-41800-034N1	K616-41800-034M1	K616-41800-034H1
	315	132	55	104 × 104 / 104 × 104	–	–	K830-41800-034H1

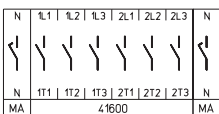

Lasttrennschalter

Hauptschalter Bodeneinbau Vierlochbefestigung mit Türverriegelung

Abmessungen in mm:

Aufbau der Bestellnummer

Typ	Schaltprogramm	Bauform
K616	41300	034N1
Best.-Nr.	K616-41300-034N1	

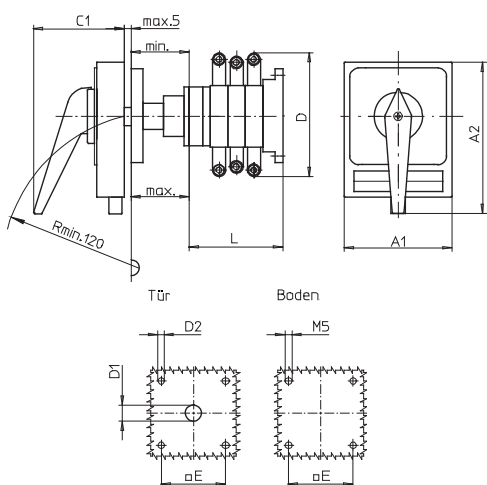
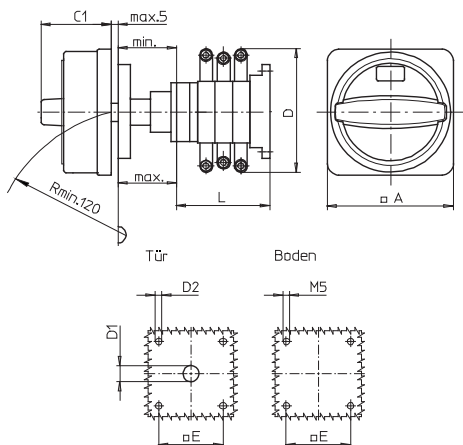

Typ K616:

Bauform	Schaltprogramm	A	C1	D*	D1	D2	E	min	max	L
034M1	41300	88	50	150	15	5,5	68	48	60	104
034M1	41400	88	50	150	15	5,5	68	48	60	104
034M1	41600	88	50	150	15	5,5	68	48	60	136
034M1	41800	88	50	150	15	5,5	68	48	60	168
034N1	41300	88	45	150	15	5,5	68	48	60	104
034N1	41400	88	45	150	15	5,5	68	48	60	104
034N1	41600	88	45	150	15	5,5	68	48	60	136
034N1	41800	88	45	150	15	5,5	68	48	60	168

Typ K616:

Bauform	Schaltprogramm	A1	A2	C1	D*	D1	D2	E	min	max	L
034H1	41300	98	142	83	150	15	5,5	68	48	60	104
034H1	41400	98	142	83	150	15	5,5	68	48	60	104
034H1	41600	98	142	83	150	15	5,5	68	48	60	136
034H1	41800	98	142	83	150	15	5,5	68	48	60	168

Typ K830:

Bauform	Schaltprogramm	A1	A2	C1	D*	D1	D2	E	min	max	L
034H1	41300	130	176	93	210	20	5,5	104	75	102	125
034H1	41400	130	176	93	210	20	5,5	104	75	102	125
034H1	41600	130	176	93	210	20	5,5	104	75	102	161
034H1	41800	130	176	93	210	20	5,5	104	75	102	197







* einschließlich Anschlusswinkel



Weitere Schaltprogramme und zugehörige Abmessungen für Typen K auf Anfrage.

Hauptschalter

- Gekapselte Schalter mit Isolierstoffgehäuse (Polycarbonat)
- Deckelverriegelung in EIN-Stellung
- 3- bis 8-polig
- 20 A bis 315 A
- IP66

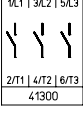



Schaltprogramm	Bemessungsdaten (IEC 60947) Betriebsstrom I_e Betriebsleistung (bei 380–440 V)			Gehäuse- abmessungen (H × B × T) (mm)	Vorhängeschlosssperre N-Griff schwarz	Vorhängeschlosssperre M-Griff schwarz	Griffverriegelung V-Griff silber/schwarz
	AC-21A (A)	AC-23A (kW)	AC-3 (kW)		  IP66	  IP66	  IP66
					Bestellnummer	Bestellnummer	Bestellnummer
41300 – 3-polig – ohne Hilfskontakte 	20	5,5	3,7	125 × 100 × 85	H216-41300-700N1	H216-41300-700M1	H216-41300-700V1
	20	5,5	3,7	175 × 115 × 100	H216-41300-710N1	H216-41300-710M1	H216-41300-710V1
	20	5,5	3,7	250 × 160 × 120	H216-41300-730N1	H216-41300-730M1	H216-41300-730V1
	25	7,5	5,5	125 × 100 × 85	H220-41300-700N1	H220-41300-700M1	H220-41300-700V1
	25	7,5	5,5	175 × 115 × 100	H220-41300-710N1	H220-41300-710M1	H220-41300-710V1
	25	7,5	5,5	250 × 160 × 120	H220-41300-730N1	H220-41300-730M1	H220-41300-730V1
	32	11	7,5	125 × 100 × 85	H226-41300-700N1	H226-41300-700M1	H226-41300-700V1
	32	11	7,5	175 × 115 × 100	H226-41300-710N1	H226-41300-710M1	H226-41300-710V1
	32	11	7,5	250 × 160 × 120	H226-41300-730N1	H226-41300-730M1	H226-41300-730V1
	40	15	11	175 × 115 × 100	H233-41300-710N1	H233-41300-710M1	H233-41300-710V1
	40	15	11	175 × 115 × 100	B240-41300-710N1*¹	B240-41300-710M1*¹	B240-41300-710V1*¹
	40	15	11	250 × 160 × 120	H233-41300-730N1	H233-41300-730M1	H233-41300-730V1
	40	15	11	250 × 160 × 120	B240-41300-730N1*	B240-41300-730M1*	B240-41300-730V1*
	50	18,5	15	175 × 115 × 100	B250-41300-710N1¹	B250-41300-710M1¹	B250-41300-710V1¹
	50	18,5	15	250 × 160 × 120	B250-41300-730N1	B250-41300-730M1	B250-41300-730V1
	63	22	18,5	175 × 115 × 100	B263-41300-710N1¹	B263-41300-710M1¹	B263-41300-710V1¹
	63	22	18,5	250 × 160 × 120	B263-41300-730N1	B263-41300-730M1	B263-41300-730V1
	63	22	18,5	250 × 160 × 120	H406-41300-730N1*	H406-41300-730M1*	–
	63	22	18,5	280 × 190 × 130	H406-41300-770N1	H406-41300-770M1	H406-41300-770V1
	63	22	18,5	320 × 220 × 180	H406-41300-471N1	H406-41300-471M1	–
	80	30	22	250 × 160 × 120	H408-41300-730N1	H408-41300-730M1	–
	80	30	22	280 × 190 × 130	H408-41300-770N1	H408-41300-770M1	H408-41300-770V1
	80	30	22	320 × 220 × 180	H408-41300-471N1	H408-41300-471M1	–
	100	37	30	250 × 160 × 120	H410-41300-730N1	H410-41300-730M1	–
	100	37	30	280 × 190 × 130	H410-41300-770N1	H410-41300-770M1	H410-41300-770V1
	100	37	30	320 × 220 × 180	H410-41300-471N1	H410-41300-471M1	–
	125	45	37	320 × 220 × 180	H412-41300-471N1	H412-41300-471M1	–

Schaltprogramm	Bemessungsdaten (IEC 60947) Betriebsstrom I_e Betriebsleistung (bei 380–440 V)			Gehäuse- abmessungen (H × B × T) (mm)	Vorhängeschlosssperre H-Griff silber/schwarz
	AC-21A (A)	AC-23A (kW)	AC-3 (kW)		  IP66
					Bestellnummer
* größerer Anschluss- querschnitt, s. Seite 154 ¹ max. Anschlussquerschnitt 16 mm ² an N- und/oder PE-Gehäuseklemme Weitere Schaltprogramme ab Seite 132.	160	75	45	440 × 320 × 180	K616-41300-077H1
	160	75	45	440 × 320 × 255	K616-41300-177H1
	315	132	55	640 × 320 × 255	K830-41300-077H1
	315	132	55	640 × 320 × 330	K830-41300-177H1

Lasttrennschalter

Hauptschalter Gekapselte Schalter mit Isolierstoffgehäuse

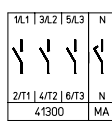

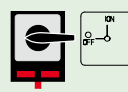
Schaltprogramm	Bemessungsdaten (IEC 60947) Betriebsstrom I_e Betriebsleistung (bei 380–440 V)			Gehäuse- abmessungen (H × B × T) (mm)	Vorhängeschlossperre N-Griff schwarz	Vorhängeschlossperre M-Griff schwarz	Griffverriegelung V-Griff silber/schwarz
	AC-21A (A)	AC-23A (kW)	AC-3 (kW)				
					Bestellnummer	Bestellnummer	Bestellnummer
41400 – 4-polig – ohne Hilfskontakte – Neutralleiter voreilend 	20	5,5	3,7	125 × 100 × 85	H216-41400-700N1	H216-41400-700M1	H216-41400-700V1
	20	5,5	3,7	175 × 115 × 100	H216-41400-710N1	H216-41400-710M1	H216-41400-710V1
	20	5,5	3,7	250 × 160 × 120	H216-41400-730N1	H216-41400-730M1	H216-41400-730V1
	25	7,5	5,5	125 × 100 × 85	H220-41400-700N1	H220-41400-700M1	H220-41400-700V1
	25	7,5	5,5	175 × 115 × 100	H220-41400-710N1	H220-41400-710M1	H220-41400-710V1
	25	7,5	5,5	250 × 160 × 120	H220-41400-730N1	H220-41400-730M1	H220-41400-730V1
	32	11	7,5	125 × 100 × 85	H226-41400-700N1	H226-41400-700M1	H226-41400-700V1
	32	11	7,5	175 × 115 × 100	H226-41400-710N1	H226-41400-710M1	H226-41400-710V1
	32	11	7,5	250 × 160 × 120	H226-41400-730N1	H226-41400-730M1	H226-41400-730V1
	40	15	11	175 × 115 × 100	H233-41400-710N1	H233-41400-710M1	H233-41400-710V1
	40	15	11	175 × 115 × 100	B240-41400-710N1*¹	B240-41400-710M1*¹	B240-41400-710V1*¹
	40	15	11	250 × 160 × 120	H233-41400-730N1	H233-41400-730M1	H233-41400-730V1
	40	15	11	250 × 160 × 120	B240-41400-730N1*	B240-41400-730M1*	B240-41400-730V1*
	50	18,5	15	175 × 115 × 100	B250-41400-710N1¹	B250-41400-710M1¹	B250-41400-710V1¹
	50	18,5	15	250 × 160 × 120	B250-41400-730N1	B250-41400-730M1	B250-41400-730V1
	63	22	18,5	175 × 115 × 100	B263-41400-710N1¹	B263-41400-710M1¹	B263-41400-710V1¹
	63	22	18,5	250 × 160 × 120	B263-41400-730N1	B263-41400-730M1	B263-41400-730V1
	63	22	18,5	250 × 160 × 120	H406-41400-730N1*	H406-41400-730M1*	–
	63	22	18,5	280 × 190 × 130	H406-41400-770N1	H406-41400-770M1	H406-41400-770V1
	63	22	18,5	320 × 220 × 180	H406-41400-471N1	H406-41400-471M1	–
	80	30	22	250 × 160 × 120	H408-41400-730N1	H408-41400-730M1	–
	80	30	22	280 × 190 × 130	H408-41400-770N1	H408-41400-770M1	H408-41400-770V1
	80	30	22	320 × 220 × 180	H408-41400-471N1	H408-41400-471M1	–
	100	37	30	250 × 160 × 120	H410-41400-730N1	H410-41400-730M1	–
	100	37	30	280 × 190 × 130	H410-41400-770N1	H410-41400-770M1	H410-41400-770V1
	100	37	30	320 × 220 × 180	H410-41400-471N1	H410-41400-471M1	–
	125	45	37	320 × 220 × 180	H412-41400-471N1	H412-41400-471M1	–

Bemessungsdaten (IEC 60947) Betriebsstrom I_e Betriebsleistung (bei 380–440 V)			Gehäuse- abmessungen (H × B × T) (mm)	Vorhängeschlossperre H-Griff silber/schwarz
AC-21A (A)	AC-23A (kW)	AC-3 (kW)		
				Bestellnummer
160	75	45	440 × 320 × 180	K616-41400-077H1
160	75	45	440 × 320 × 255	K616-41400-177H1
315	132	55	640 × 320 × 255	K830-41400-077H1
315	132	55	640 × 320 × 330	K830-41400-177H1

* größerer Anschlussquerschnitt, siehe Seite 154

¹ max. Anschlussquerschnitt 16 mm² an N- und/oder PE-Gehäuseklemme

Weitere Schaltprogramme ab Seite 132.

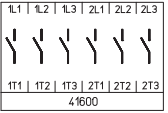
Schaltprogramm	Bemessungsdaten (IEC 60947) Betriebsstrom I_e Betriebsleistung (bei 380–440 V)			Gehäuse- abmessungen (H × B × T) (mm)	Vorhängeschlossperre N-Griff schwarz  IP66	Vorhängeschlossperre M-Griff schwarz  IP66	Griffverriegelung V-Griff silber/schwarz  IP66
	AC-21A (A)	AC-23A (kW)	AC-3 (kW)		Bestellnummer	Bestellnummer	Bestellnummer
41600 – 6-polig – ohne Hilfskontakte 	20	5,5	3,7	175 × 115 × 100	H216-41600-720N1	H216-41600-720M1	H216-41600-720V1
	20	5,5	3,7	250 × 160 × 120	H216-41600-733N1	H216-41600-733M1	H216-41600-733V1
	25	7,5	5,5	175 × 115 × 100	H220-41600-720N1	H220-41600-720M1	H220-41600-720V1
	25	7,5	5,5	250 × 160 × 120	H220-41600-733N1	H220-41600-733M1	H220-41600-733V1
	32	11	7,5	175 × 115 × 100	H226-41600-720N1	H226-41600-720M1	H226-41600-720V1
	32	11	7,5	250 × 160 × 120	H226-41600-733N1	H226-41600-733M1	H226-41600-733V1
	40	15	11	175 × 115 × 100	H233-41600-720N1	H233-41600-720M1	H233-41600-720V1
	40	15	11	250 × 160 × 120	H233-41600-733N1	H233-41600-733M1	H233-41600-733V1
	40	15	11	320 × 220 × 180	B240-41600-977N1	B240-41600-977M1	–
	50	18,5	15	320 × 220 × 180	B250-41600-977N1	B250-41600-977M1	–
	63	22	18,5	320 × 220 × 180	B263-41600-977N1	B263-41600-977M1	–
	63	22	18,5	320 × 220 × 180	H406-41600-977N1*	H406-41600-977M1*	–
	63	22	18,5	440 × 320 × 180	H406-41600-577N1	H406-41600-577M1	–
	80	30	22	320 × 220 × 180	H408-41600-977N1	H408-41600-977M1	–
	80	30	22	440 × 320 × 180	H408-41600-577N1	H408-41600-577M1	–
	100	37	30	320 × 220 × 180	H410-41600-977N1	H410-41600-977M1	–
	100	37	30	440 × 320 × 180	H410-41600-577N1	H410-41600-577M1	–
125	45	37	320 × 220 × 180	H412-41600-977N1	H412-41600-977M1	–	
125	45	37	440 × 320 × 180	H412-41600-577N1	H412-41600-577M1	–	

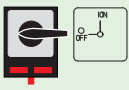

Bemessungsdaten (IEC 60947) Betriebsstrom I_e Betriebsleistung (bei 380–440 V)			Gehäuse- abmessungen (H × B × T) (mm)	Vorhängeschlossperre H-Griff silber/schwarz  IP66
AC-21A (A)	AC-23A (kW)	AC-3 (kW)		Bestellnummer
160	75	45	440 × 320 × 255	K616-41600-177H1
315	132	55	640 × 320 × 330	K830-41600-177H1

* größerer Anschlussquerschnitt, siehe Seite 154

Weitere Schaltprogramme ab Seite 132.

Lasttrennschalter

Hauptschalter Gekapselte Schalter mit Isolierstoffgehäuse

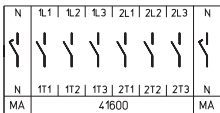
Schaltprogramm	Bemessungsdaten (IEC 60947) Betriebsstrom I_e Betriebsleistung (bei 380–440 V)			Gehäuse- abmessungen (H × B × T) (mm)	Vorhängeschlossperre N-Griff schwarz	Vorhängeschlossperre M-Griff schwarz	Griffverriegelung V-Griff silber/schwarz
	AC-21A (A)	AC-23A (kW)	AC-3 (kW)		 OFF ON IP66	 OFF ON IP66	 OFF ON IP66
					Bestellnummer	Bestellnummer	Bestellnummer
41800 – 8-polig – ohne Hilfskontakte – 2 Neutralleiter voreilend 	20	5,5	3,7	250 × 160 × 120	H216-41800-733N1	H216-41800-733M1	H216-41800-733V1
	20	5,5	3,7	280 × 190 × 130	H216-41800-770N1	H216-41800-770M1	H216-41800-770V1
	25	7,5	5,5	250 × 160 × 120	H220-41800-733N1	H220-41800-733M1	H220-41800-733V1
	25	7,5	5,5	280 × 190 × 130	H220-41800-770N1	H220-41800-770M1	H220-41800-770V1
	32	11	7,5	250 × 160 × 120	H226-41800-733N1	H226-41800-733M1	H226-41800-733V1
	32	11	7,5	280 × 190 × 130	H226-41800-770N1	H226-41800-770M1	H226-41800-770V1
	40	15	11	250 × 160 × 120	H233-41800-733N1	H233-41800-733M1	H233-41800-733V1
	40	15	11	280 × 190 × 130	H233-41800-770N1	H233-41800-770M1	H233-41800-770V1
	40	15	11	280 × 190 × 130	B240-41800-770N1*¹	B240-41800-770M1*¹	B240-41800-770V1*¹
	40	15	11	320 × 220 × 180	B240-41800-977N1	B240-41800-977M1	–
	50	18,5	15	280 × 190 × 130	B250-41800-770N1¹	B250-41800-770M1¹	B250-41800-770V1¹
	50	18,5	15	320 × 220 × 180	B250-41800-977N1	B250-41800-977M1	–
	63	22	18,5	280 × 190 × 130	B263-41800-770N1¹	B263-41800-770M1¹	B263-41800-770V1¹
	63	22	18,5	320 × 220 × 180	B263-41800-977N1	B263-41800-977M1	–
	63	22	18,5	320 × 220 × 180	H406-41800-977N1*	H406-41800-977M1*	–
	63	22	18,5	440 × 320 × 180	H406-41800-577N1	H406-41800-577M1	–
	80	30	22	320 × 220 × 180	H408-41800-977N1	H408-41800-977M1	–
	80	30	22	440 × 320 × 180	H408-41800-577N1	H408-41800-577M1	–
	100	37	30	320 × 220 × 180	H410-41800-977N1	H410-41800-977M1	–
100	37	30	440 × 320 × 180	H410-41800-577N1	H410-41800-577M1	–	
125	45	37	320 × 220 × 180	H412-41800-977N1	H412-41800-977M1	–	
125	45	37	440 × 320 × 180	H412-41800-577N1	H412-41800-577M1	–	

Bemessungsdaten (IEC 60947) Betriebsstrom I_e Betriebsleistung (bei 380–440 V)			Gehäuse- abmessungen (H × B × T) (mm)	Vorhängeschlossperre H-Griff silber/schwarz
AC-21A (A)	AC-23A (kW)	AC-3 (kW)		 OFF ON IP66
				Bestellnummer
160	75	45	440 × 320 × 255	K616-41800-177H1
315	132	55	640 × 320 × 330	K830-41800-177H1

* größerer Anschlussquerschnitt, siehe Seite 154

¹ max. Anschlussquerschnitt 16 mm² an N- und/oder PE-Gehäuseklemme

Weitere Schaltprogramme ab Seite 132.

Abmessungen in mm:

Aufbau der Bestellnummer

Typ	Schaltprogramm	Bauform
H216	41400	700M1
Best.-Nr.	H216-41400-700M1	

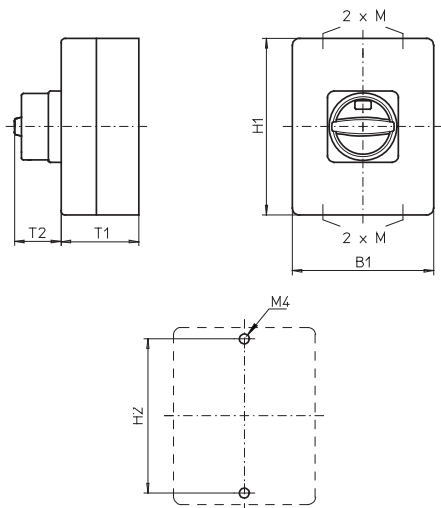

Isolierstoffgehäuse **125 × 100 × 85 mm**
und **175 × 115 × 100 mm**:

Typen H216 / H220 / H226 / H233 / B240 / B250 / B263:

Bauform	H1	B1	T1	T2	2×M	H2
700M1	125	100	85	38	20/25	115
700N1	125	100	85	33	20/25	115
700V1	125	100	85	32	20/25	115
710M1	175	115	100	38	20/25	165
710N1	175	115	100	33	20/25	165
710V1	175	115	100	39	20/25	165
720M1	175	115	100	38	20/25	165
720N1	175	115	100	33	20/25	165
720V1	175	115	100	39	20/25	165

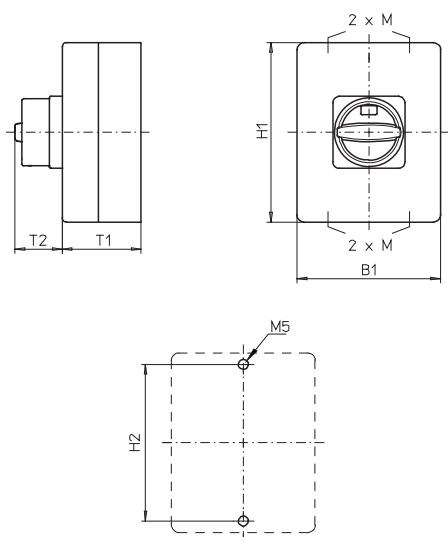

Isolierstoffgehäuse **250 × 160 × 120 mm**:

Typen H216 / H220 / H226 / H233:

Bauform	H1	B1	T1	T2	2×M	H2
730M1	250	160	120	38	32/40	235
730N1	250	160	120	33	32/40	235
730V1	250	160	120	39	32/40	235
733M1	250	160	120	38	32/40	235
733N1	250	160	120	33	32/40	235
733V1	250	160	120	39	32/40	235

Typen B240 / B250 / B263:

Bauform	H1	B1	T1	T2	2×M	H2
730M1	250	160	120	50	32/40	235
730N1	250	160	120	45	32/40	235
730V1	250	160	120	39	32/40	235

Typen H406 / H408 / H410 / H412:

Bauform	H1	B1	T1	T2	2×M	H2
730M1	250	160	120	50	32/40	235
730N1	250	160	120	45	32/40	235

Lasttrennschalter

Hauptschalter Gekapselte Schalter mit Isolierstoffgehäuse

Abmessungen in mm:

Aufbau der Bestellnummer		
Typ	Schaltprogramm	Bauform
H406	41300	770M1
Best.-Nr.	H406-41300-770M1	

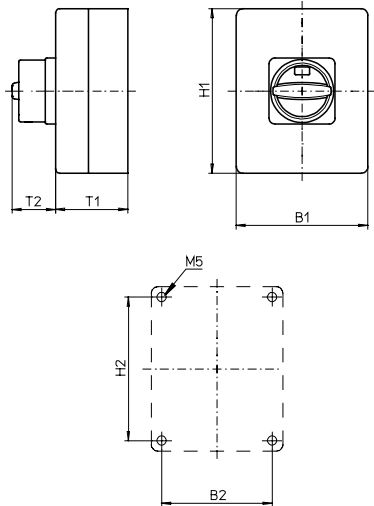

Isolierstoffgehäuse **280 × 190 × 130 mm**
und **320 × 220 × 180 mm**:

Typen H216 / H220 / H226 / H233 / B240 / B250 / B263 /
H406 / H408 / H410 / H412:

Bauform	H1	B1	T1	T2	2×M	H2	B2
770M1	280	190	130	50	40×1,5	254	164
770N1	280	190	130	45	40×1,5	254	164
770V1	280	190	130	39	40×1,5	254	164
471M1	320	220	180	50	- ¹	293	193
471N1	320	220	180	45	- ¹	293	193
977M1	320	220	180	50	- ¹	293	193
977N1	320	220	180	45	- ¹	293	193

¹ Flanschplatten ohne Vorprägungen

Isolierstoffgehäuse **440 × 320 × 180 mm /**
440 × 320 × 255 mm / 640 × 320 × 255 mm /
640 × 320 × 330 mm:

Typen H406 / H408 / H410 / H412:

Bauform	H1	B1	T1	T2	H2	B2
577M1	440	320	180	50	480	293
577N1	440	320	180	45	480	293

Typ K616:

Bauform	H1	B1	T1	T2	H2	B2
077H1	440	320	180	83	480	293
177H1	440	320	255	83	480	293

Typ K830:

Bauform	H1	B1	T1	T2	H2	B2
077H1	640	320	255	93	680	293
177H1	640	320	330	93	680	293

Weitere Schaltprogramme und zugehörige Abmessungen für Typen K auf Anfrage.

Flanschplatten ohne Vorprägungen

Zugehörige Befestigungslaschen sind im Lieferumfang enthalten.

Hauptschalter

- Gekapselte Schalter mit Isolierstoffgehäuse (Polycarbonat)
- EMV-Anwendung, Verbindungssystem zur unterbrechungsfreien Durchführung abgeschirmter Kabel bestehend aus Schirmblech und 4 Schirmklammern $\varnothing 12-16$ mm
- Deckelverriegelung in EIN-Stellung
- 3- bis 6-polig
- 20 A bis 63 A
- IP66



Schaltprogramm	Bemessungsdaten (IEC 60947) Betriebs- Betriebsleistung strom I_e (bei 380–440 V)			Gehäuse- abmessungen (H × B × T) (mm)	Vorhängeschlosssperre N-Griff schwarz	Vorhängeschlosssperre M-Griff schwarz	Griffverriegelung V-Griff silber/schwarz
	AC-21A (A)	AC-23A (kW)	AC-3 (kW)				
41300 – 3-polig – ohne Hilfskontakte	20	5,5	3,7	175 × 115 × 100			
	25	7,5	5,5	175 × 115 × 100	H216-41300-715N1	H216-41300-715M1	H216-41300-715V1
	32	11	7,5	175 × 115 × 100	H220-41300-715N1	H220-41300-715M1	H220-41300-715V1
	40	15	11	175 × 115 × 100	H226-41300-715N1	H226-41300-715M1	H226-41300-715V1
	40	15	11	175 × 115 × 100	H233-41300-715N1	H233-41300-715M1	H233-41300-715V1
	50	18,5	15	175 × 115 × 100	B240-41300-715N1*	B240-41300-715M1*	B240-41300-715V1*
	63	22	18,5	175 × 115 × 100	B250-41300-715N1	B250-41300-715M1	B250-41300-715V1
					B263-41300-715N1	B263-41300-715M1	B263-41300-715V1
41400 – 4-polig – ohne Hilfskontakte – Neutralleiter voreilend	20	5,5	3,7	175 × 115 × 100	H216-41400-715N1	H216-41400-715M1	H216-41400-715V1
	25	7,5	5,5	175 × 115 × 100	H220-41400-715N1	H220-41400-715M1	H220-41400-715V1
	32	11	7,5	175 × 115 × 100	H226-41400-715N1	H226-41400-715M1	H226-41400-715V1
	40	15	11	175 × 115 × 100	H233-41400-715N1	H233-41400-715M1	H233-41400-715V1
	40	15	11	175 × 115 × 100	B240-41400-715N1*	B240-41400-715M1*	B240-41400-715V1*
	50	18,5	15	175 × 115 × 100	B250-41400-715N1	B250-41400-715M1	B250-41400-715V1
	63	22	18,5	175 × 115 × 100	B263-41400-715N1	B263-41400-715M1	B263-41400-715V1
41600 – 6-polig – ohne Hilfskontakte	20	5,5	3,7	175 × 115 × 100	H216-41600-725N1	H216-41600-725M1	H216-41600-725V1
	25	7,5	5,5	175 × 115 × 100	H220-41600-725N1	H220-41600-725M1	H220-41600-725V1
	32	11	7,5	175 × 115 × 100	H226-41600-725N1	H226-41600-725M1	H226-41600-725V1
	40	15	11	175 × 115 × 100	H233-41600-725N1	H233-41600-725M1	H233-41600-725V1

* größerer Anschlussquerschnitt, siehe Seite 154

Weitere Schaltprogramme ab Seite 132.

Abmessungen in mm:

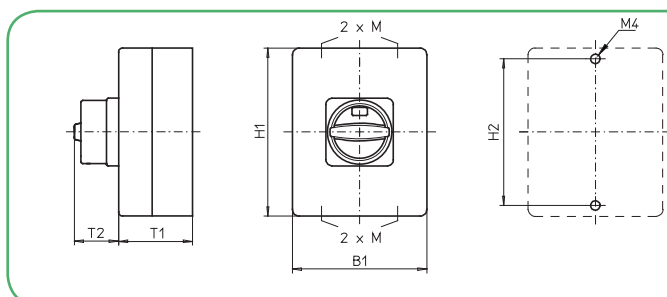

Typen H216 / H220 / H226 / H233 / B240 / B250 / B263:

Bauform	H1	B1	T1	T2	2×M	H2
715M1	175	115	100	38	20/25	165
715N1	175	115	100	33	20/25	165
715V1	175	115	100	39	20/25	165
725M1	175	115	100	38	20/25	165
725N1	175	115	100	33	20/25	165
725V1	175	115	100	39	20/25	165









Lasttrennschalter

Hauptschalter Gekapselte Schalter mit Stahlgehäuse

Hauptschalter

- Gekapselte Schalter mit Stahlgehäuse (pulverbeschichtet)
- Deckelverriegelung in EIN-Stellung
- 3- bis 8-polig
- 20 A bis 315 A
- IP66

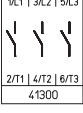





Schaltprogramm	Bemessungsdaten (IEC 60947) Betriebs- Betriebsleistung strom I _e (bei 380–440 V)			Gehäuse- abmessungen (H × B × T) (mm)	Vorhängeschlosssperre N-Griff schwarz	Vorhängeschlosssperre M-Griff schwarz	Griffverriegelung V-Griff silber/schwarz
	AC-21A (A)	AC-23A (kW)	AC-3 (kW)		  IP66	  IP66	  IP66
					Bestellnummer	Bestellnummer	Bestellnummer
41300 – 3-polig – ohne Hilfskontakte 	20	5,5	3,7	150 × 150 × 120	H216-41300-087N1	H216-41300-087M1	H216-41300-087V1
	20	5,5	3,7	200 × 150 × 120	H216-41300-187N1	H216-41300-187M1	H216-41300-187V1
	25	7,5	5,5	150 × 150 × 120	H220-41300-087N1	H220-41300-087M1	H220-41300-087V1
	25	7,5	5,5	200 × 150 × 120	H220-41300-187N1	H220-41300-187M1	H220-41300-187V1
	32	11	7,5	150 × 150 × 120	H226-41300-087N1	H226-41300-087M1	H226-41300-087V1
	32	11	7,5	200 × 150 × 120	H226-41300-187N1	H226-41300-187M1	H226-41300-187V1
	40	15	11	200 × 150 × 120	H233-41300-187N1	H233-41300-187M1	H233-41300-187V1
	40	15	11	200 × 150 × 120	B240-41300-087N1*	B240-41300-087M1*	B240-41300-087V1*
	50	18,5	15	200 × 150 × 120	B250-41300-087N1	B250-41300-087M1	B250-41300-087V1
	63	22	18,5	200 × 150 × 120	B263-41300-087N1	B263-41300-087M1	B263-41300-087V1
	63	22	18,5	200 × 150 × 120	H406-41300-987N1*	H406-41300-987M1*	–
	63	22	18,5	300 × 250 × 150	H406-41300-187N1	H406-41300-187M1	–
	63	22	18,5	400 × 300 × 155	H406-41300-182N1¹	H406-41300-182M1¹	–
	80	30	22	200 × 150 × 120	H408-41300-987N1	H408-41300-987M1	–
	80	30	22	300 × 250 × 150	H408-41300-187N1	H408-41300-187M1	–
	80	30	22	400 × 300 × 155	H408-41300-182N1¹	H408-41300-182M1¹	–
	100	37	30	300 × 250 × 150	H410-41300-187N1	H410-41300-187M1	–
100	37	30	400 × 300 × 155	H410-41300-182N1¹	H410-41300-182M1¹	–	
125	45	37	300 × 250 × 150	H412-41300-187N1	H412-41300-187M1	–	
125	45	37	400 × 300 × 155	H412-41300-182N1¹	H412-41300-182M1¹	–	
	Bemessungsdaten (IEC 60947) Betriebs- Betriebsleistung strom I _e (bei 380–440 V)			Gehäuse- abmessungen (H × B × T) (mm)	Vorhängeschlosssperre H-Griff silber/schwarz		
	AC-21A (A)	AC-23A (kW)	AC-3 (kW)		  IP66	Bestellnummer	
	160	75	45	500 × 400 × 300	K616-41300-187H1¹		
	315	132	55	600 × 400 × 300	K830-41300-187H1¹		
	315	132	55	800 × 400 × 300	K830-41300-287H1¹		

* größerer Anschlussquerschnitt, siehe Seite 154

¹ mit Tür

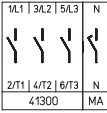
Weitere Schaltprogramme ab Seite 132.

Schaltprogramm	Bemessungsdaten (IEC 60947) Betriebsstrom I_e Betriebsleistung (bei 380–440 V)			Gehäuse- abmessungen (H × B × T) (mm)	Vorhängeschlossperre N-Griff schwarz  OFF ON IP66	Vorhängeschlossperre M-Griff schwarz  ON IP66	Griffverriegelung V-Griff silber/schwarz  ON IP66
	AC-21A (A)	AC-23A (kW)	AC-3 (kW)		Bestellnummer	Bestellnummer	Bestellnummer
41400 – 4-polig – ohne Hilfskontakte – Neutralleiter voreilend 	20	5,5	3,7	150 × 150 × 120	H216-41400-087N1	H216-41400-087M1	H216-41400-087V1
	20	5,5	3,7	200 × 150 × 120	H216-41400-187N1	H216-41400-187M1	H216-41400-187V1
	25	7,5	5,5	150 × 150 × 120	H220-41400-087N1	H220-41400-087M1	H220-41400-087V1
	25	7,5	5,5	200 × 150 × 120	H220-41400-187N1	H220-41400-187M1	H220-41400-187V1
	32	11	7,5	150 × 150 × 120	H226-41400-087N1	H226-41400-087M1	H226-41400-087V1
	32	11	7,5	200 × 150 × 120	H226-41400-187N1	H226-41400-187M1	H226-41400-187V1
	40	15	11	200 × 150 × 120	H233-41400-187N1	H233-41400-187M1	H233-41400-187V1
	40	15	11	200 × 150 × 120	B240-41400-087N1*	B240-41400-087M1*	B240-41400-087V1*
	50	18,5	15	200 × 150 × 120	B250-41400-087N1	B250-41400-087M1	B250-41400-087V1
	63	22	18,5	200 × 150 × 120	B263-41400-087N1	B263-41400-087M1	B263-41400-087V1
	63	22	18,5	200 × 150 × 120	H406-41400-987N1*	H406-41400-987M1*	–
	63	22	18,5	300 × 250 × 150	H406-41400-187N1	H406-41400-187M1	–
	63	22	18,5	400 × 300 × 155	H406-41400-182N1¹	H406-41400-182M1¹	–
	80	30	22	200 × 150 × 120	H408-41400-987N1	H408-41400-987M1	–
	80	30	22	300 × 250 × 150	H408-41400-187N1	H408-41400-187M1	–
	80	30	22	400 × 300 × 155	H408-41400-182N1¹	H408-41400-182M1¹	–
100	37	30	300 × 250 × 150	H410-41400-187N1	H410-41400-187M1	–	
100	37	30	400 × 300 × 155	H410-41400-182N1¹	H410-41400-182M1¹	–	
125	45	37	300 × 250 × 150	H412-41400-187N1	H412-41400-187M1	–	
125	45	37	400 × 300 × 155	H412-41400-182N1¹	H412-41400-182M1¹	–	

Bemessungsdaten (IEC 60947) Betriebsstrom I_e Betriebsleistung (bei 380–440 V)			Gehäuse- abmessungen (H × B × T) (mm)	Vorhängeschlossperre H-Griff silber/schwarz  ON IP66
AC-21A (A)	AC-23A (kW)	AC-3 (kW)		Bestellnummer
160	75	45	500 × 400 × 300	K616-41400-187H1¹
315	132	55	600 × 400 × 300	K830-41400-187H1¹
315	132	55	800 × 400 × 300	K830-41400-287H1¹



* größerer Anschlussquerschnitt, siehe Seite 154

¹ mit Tür

Weitere Schaltprogramme ab Seite 132.

Lasttrennschalter

Hauptschalter Gekapselte Schalter mit Stahlgehäuse

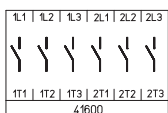
Schaltprogramm	Bemessungsdaten (IEC 60947) Betriebsstrom I_e Betriebsleistung (bei 380–440 V)			Gehäuse- abmessungen (H × B × T) (mm)	Vorhängeschlossperre N-Griff schwarz	Vorhängeschlossperre M-Griff schwarz	Griffverriegelung V-Griff silber/schwarz
	AC-21A (A)	AC-23A (kW)	AC-3 (kW)				
					Bestellnummer	Bestellnummer	Bestellnummer
41600 – 6-polig – ohne Hilfskontakte 	20	5,5	3,7	200 × 150 × 120	H216-41600-187N1	H216-41600-187M1	H216-41600-187V1
	25	7,5	5,5	200 × 150 × 120	H220-41600-187N1	H220-41600-187M1	H220-41600-187V1
	32	11	7,5	200 × 150 × 120	H226-41600-187N1	H226-41600-187M1	H226-41600-187V1
	40	15	11	200 × 150 × 120	H233-41600-187N1	H233-41600-187M1	H233-41600-187V1
	40	15	11	300 × 250 × 150	B240-41600-187N1	B240-41600-187M1	–
	50	18,5	15	300 × 250 × 150	B250-41600-187N1	B250-41600-187M1	–
	63	22	18,5	300 × 250 × 150	B263-41600-187N1	B263-41600-187M1	–
	63	22	18,5	300 × 250 × 150	H406-41600-187N1*	H406-41600-187M1*	–
	63	22	18,5	400 × 300 × 155	H406-41600-182N1¹	H406-41600-182M1¹	–
	80	30	22	300 × 250 × 150	H408-41600-187N1	H408-41600-187M1	–
	80	30	22	400 × 300 × 155	H408-41600-182N1¹	H408-41600-182M1¹	–
	100	37	30	300 × 250 × 150	H410-41600-187N1	H410-41600-187M1	–
	100	37	30	400 × 300 × 155	H410-41600-182N1¹	H410-41600-182M1¹	–
	125	45	37	300 × 250 × 150	H412-41600-187N1	H412-41600-187M1	–
	125	45	37	400 × 300 × 155	H412-41600-182N1¹	H412-41600-182M1¹	–

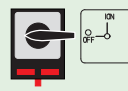
Bemessungsdaten (IEC 60947) Betriebsstrom I_e Betriebsleistung (bei 380–440 V)			Gehäuse- abmessungen (H × B × T) (mm)	Vorhängeschlossperre H-Griff silber/schwarz	
AC-21A (A)	AC-23A (kW)	AC-3 (kW)			Bestellnummer
160	75	45	500 × 400 × 300	K616-41600-187H1¹	
315	132	55	600 × 400 × 300	K830-41600-187H1¹	
315	132	55	800 × 400 × 300	K830-41600-287H1¹	

* größerer Anschlussquerschnitt, siehe Seite 154

¹ mit Tür

Weitere Schaltprogramme ab Seite 132.

Schaltprogramm	Bemessungsdaten (IEC 60947) Betriebs- Betriebsleistung strom I _e (bei 380–440 V)			Gehäuse- abmessungen (H × B × T) (mm)	Vorhängeschlossperre N-Griff schwarz	Vorhängeschlossperre M-Griff schwarz	Griffverriegelung V-Griff silber/schwarz
	AC-21A (A)	AC-23A (kW)	AC-3 (kW)				
					Bestellnummer	Bestellnummer	Bestellnummer
41800 – 8-polig – ohne Hilfskontakte – 2 Neutralleiter voreilend 	20	5,5	3,7	200 × 150 × 120	H216-41800-187N1	H216-41800-187M1	H216-41800-187V1
	25	7,5	5,5	200 × 150 × 120	H220-41800-187N1	H220-41800-187M1	H220-41800-187V1
	32	11	7,5	200 × 150 × 120	H226-41800-187N1	H226-41800-187M1	H226-41800-187V1
	40	15	11	200 × 150 × 120	H233-41800-187N1	H233-41800-187M1	H233-41800-187V1
	40	15	11	300 × 250 × 150	B240-41800-187N1	B240-41800-187M1	–
	50	18,5	15	300 × 250 × 150	B250-41800-187N1	B250-41800-187M1	–
	63	22	18,5	300 × 250 × 150	B263-41800-187N1	B263-41800-187M1	–
	63	22	18,5	300 × 250 × 150	H406-41800-187N1*	H406-41800-187M1*	–
	63	22	18,5	400 × 300 × 155	H406-41800-182N1¹	H406-41800-182M1¹	–
	80	30	22	300 × 250 × 150	H408-41800-187N1	H408-41800-187M1	–
	80	30	22	400 × 300 × 155	H408-41800-182N1¹	H408-41800-182M1¹	–
	100	37	30	300 × 250 × 150	H410-41800-187N1	H410-41800-187M1	–
	100	37	30	400 × 300 × 155	H410-41800-182N1¹	H410-41800-182M1¹	–
	125	45	37	300 × 250 × 150	H412-41800-187N1	H412-41800-187M1	–
	125	45	37	400 × 300 × 155	H412-41800-182N1¹	H412-41800-182M1¹	–

Bemessungsdaten (IEC 60947) Betriebs- Betriebsleistung strom I _e (bei 380–440 V)			Gehäuse- abmessungen (H × B × T) (mm)	Vorhängeschlossperre H-Griff silber/schwarz	
AC-21A (A)	AC-23A (kW)	AC-3 (kW)			Bestellnummer
160	75	45	500 × 400 × 300	K616-41800-187H1¹	
315	132	55	600 × 400 × 300	K830-41800-187H1¹	
315	132	55	800 × 400 × 300	K830-41800-287H1¹	

* größerer Anschlussquerschnitt, siehe Seite 154

¹ mit Tür

Weitere Schaltprogramme ab Seite 132.

Lasttrennschalter

Hauptschalter Gekapselte Schalter mit Stahlgehäuse

Abmessungen in mm:

Aufbau der Bestellnummer

Typ	Schaltprogramm	Bauform
H216	41400	087M1
Best.-Nr.	H216-41400-087M1	

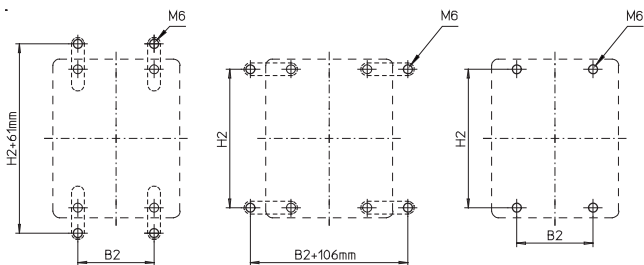
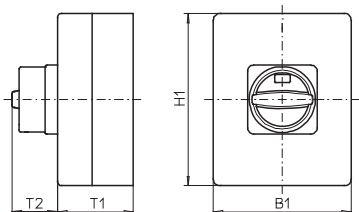

Zugehörige Befestigungslaschen bitte getrennt bestellen, siehe Seite 148.

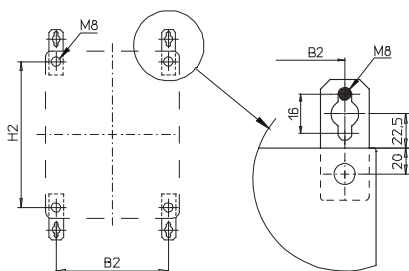
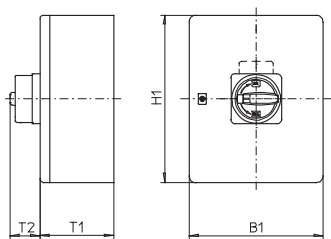

Zugehörige Befestigungslaschen bitte getrennt bestellen, siehe Seite 148.

Stahlgehäuse **150 × 150 × 120 mm / 200 × 150 × 120 mm / 300 × 250 × 150 mm:**

Typen H216 / H220 / H226 / H233:

Bauform	H1	B1	T1	T2	H2	B2
087M1	150	150	120	38	132	85
087N1	150	150	120	33	132	85
087V1	150	150	120	39	132	85
187M1	200	150	120	38	182	85
187N1	200	150	120	33	182	85
187V1	200	150	120	39	182	85

Typen B240 / B250 / B263:

Bauform	H1	B1	T1	T2	H2	B2
087M1	200	150	120	38	182	85
087N1	200	150	120	33	182	85
087V1	200	150	120	39	182	85
187M1	300	250	150	50	282	185
187N1	300	250	150	45	282	185

Typen H406 / H408 / H410 / H412:

Bauform	H1	B1	T1	T2	H2	B2
187M1	300	250	150	50	282	185
187N1	300	250	150	45	282	185
987M1	200	150	120	50	182	85
987N1	200	150	120	45	182	85

Stahlgehäuse **400 × 300 × 155 mm:**

Typen H406 / H408 / H410 / H412:

Bauform	H1	B1	T1	T2	H2	B2
182M1	400	300	155	50	360	260
182N1	400	300	155	45	360	260

Flanschplatte unten

Abmessungen in mm:

Aufbau der Bestellnummer

Typ	Schaltprogramm	Bauform
K616	41300	187H1
Best.-Nr.	K616-41300-187H1	

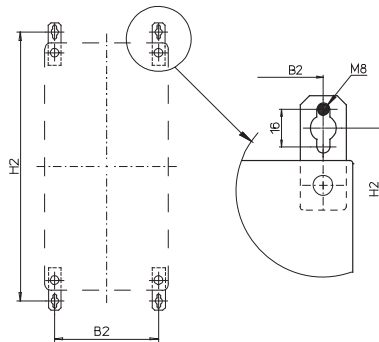
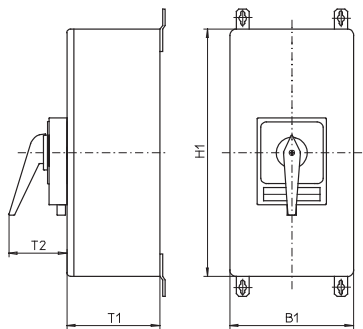

Zugehörige Befestigungslaschen sind im Lieferumfang enthalten.

Stahlgehäuse **500 × 400 × 300 mm / 600 × 400 × 300 mm / 800 × 400 × 300 mm:**

Typ K616:

Bauform	H1	B1	T1	T2	H2	B2
187H1	500	400	300	83	545	360

Typ K830:

Bauform	H1	B1	T1	T2	H2	B2
187H1	600	400	300	93	645	360
287H1	800	400	300	93	845	360

Weitere Schaltprogramme und zugehörige Abmessungen für Typen K auf Anfrage.

Flanschplatte unten







Lasttrennschalter

Hauptschalter Gekapselte Schalter mit Edelstahlgehäuse

Hauptschalter

- Gekapselte Schalter mit Edelstahlgehäuse (gebürstet)
- Deckelverriegelung in EIN-Stellung
- 3- bis 8-polig
- 20 A bis 125 A
- IP66

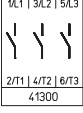
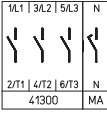

Schaltprogramm	Bemessungsdaten (IEC 60947) Betriebs- Betriebsleistung strom I _e (bei 380–440 V)			Gehäuse- abmessungen (H × B × T) (mm)	Vorhängeschlosssperre N-Griff schwarz	Vorhängeschlosssperre M-Griff schwarz	Griffverriegelung V-Griff silber/schwarz
	AC-21A (A)	AC-23A (kW)	AC-3 (kW)		 	 	 
					IP66	IP66	IP66
					Bestellnummer	Bestellnummer	Bestellnummer
41300 – 3-polig – ohne Hilfskontakte 	20	5,5	3,7	150 × 150 × 120	H216-41300-097N1	H216-41300-097M1	H216-41300-097V1
	20	5,5	3,7	200 × 150 × 120	H216-41300-197N1	H216-41300-197M1	H216-41300-197V1
	25	7,5	5,5	150 × 150 × 120	H220-41300-097N1	H220-41300-097M1	H220-41300-097V1
	25	7,5	5,5	200 × 150 × 120	H220-41300-197N1	H220-41300-197M1	H220-41300-197V1
	32	11	7,5	150 × 150 × 120	H226-41300-097N1	H226-41300-097M1	H226-41300-097V1
	32	11	7,5	200 × 150 × 120	H226-41300-197N1	H226-41300-197M1	H226-41300-197V1
	40	15	11	200 × 150 × 120	H233-41300-197N1	H233-41300-197M1	H233-41300-197V1
	40	15	11	200 × 150 × 120	B240-41300-097N1*	B240-41300-097M1*	B240-41300-097V1*
	50	18,5	15	200 × 150 × 120	B250-41300-097N1	B250-41300-097M1	B250-41300-097V1
	63	22	18,5	200 × 150 × 120	B263-41300-097N1	B263-41300-097M1	B263-41300-097V1
	63	22	18,5	200 × 150 × 120	H406-41300-997N1*	H406-41300-997M1*	–
	63	22	18,5	300 × 250 × 150	H406-41300-197N1	H406-41300-197M1	–
	80	30	22	200 × 150 × 120	H408-41300-997N1	H408-41300-997M1	–
	80	30	22	300 × 250 × 150	H408-41300-197N1	H408-41300-197M1	–
	100	37	30	300 × 250 × 150	H410-41300-197N1	H410-41300-197M1	–
125	45	37	300 × 250 × 150	H412-41300-197N1	H412-41300-197M1	–	
41400 – 4-polig – ohne Hilfskontakte – Neutralleiter voreilend 	20	5,5	3,7	150 × 150 × 120	H216-41400-097N1	H216-41400-097M1	H216-41400-097V1
	20	5,5	3,7	200 × 150 × 120	H216-41400-197N1	H216-41400-197M1	H216-41400-197V1
	25	7,5	5,5	150 × 150 × 120	H220-41400-097N1	H220-41400-097M1	H220-41400-097V1
	25	7,5	5,5	200 × 150 × 120	H220-41400-197N1	H220-41400-197M1	H220-41400-197V1
	32	11	7,5	150 × 150 × 120	H226-41400-097N1	H226-41400-097M1	H226-41400-097V1
	32	11	7,5	200 × 150 × 120	H226-41400-197N1	H226-41400-197M1	H226-41400-197V1
	40	15	11	200 × 150 × 120	H233-41400-197N1	H233-41400-197M1	H233-41400-197V1
	40	15	11	200 × 150 × 120	B240-41400-097N1*	B240-41400-097M1*	B240-41400-097V1*
	50	18,5	15	200 × 150 × 120	B250-41400-097N1	B250-41400-097M1	B250-41400-097V1
	63	22	18,5	200 × 150 × 120	B263-41400-097N1	B263-41400-097M1	B263-41400-097V1
	63	22	18,5	200 × 150 × 120	H406-41400-997N1*	H406-41400-997M1*	–
	63	22	18,5	300 × 250 × 150	H406-41400-197N1	H406-41400-197M1	–
	80	30	22	200 × 150 × 120	H408-41400-997N1	H408-41400-997M1	–
	80	30	22	300 × 250 × 150	H408-41400-197N1	H408-41400-197M1	–
	100	37	30	300 × 250 × 150	H410-41400-197N1	H410-41400-197M1	–
125	45	37	300 × 250 × 150	H412-41400-197N1	H412-41400-197M1	–	

* größerer Anschlussquerschnitt, siehe Seite 154

Weitere Schaltprogramme ab Seite 132.

Lasttrennschalter

Hauptschalter Gekapselte Schalter mit Edelstahlgehäuse

Schaltprogramm	Bemessungsdaten (IEC 60947) Betriebsstrom I_e Betriebsleistung (bei 380–440 V)			Gehäuse- abmessungen (H × B × T) (mm)	Vorhängeschlossperre N-Griff schwarz IP66	Vorhängeschlossperre M-Griff schwarz IP66	Griffverriegelung V-Griff silber/schwarz IP66
	AC-21A (A)	AC-23A (kW)	AC-3 (kW)		Bestellnummer	Bestellnummer	Bestellnummer
41600 – 6-polig – ohne Hilfskontakte 	20	5,5	3,7	200 × 150 × 120	H216-41600-197N1	H216-41600-197M1	H216-41600-197V1
	25	7,5	5,5	200 × 150 × 120	H220-41600-197N1	H220-41600-197M1	H220-41600-197V1
	32	11	7,5	200 × 150 × 120	H226-41600-197N1	H226-41600-197M1	H226-41600-197V1
	40	15	11	200 × 150 × 120	H233-41600-197N1	H233-41600-197M1	H233-41600-197V1
	40	15	11	300 × 250 × 150	B240-41600-197N1	B240-41600-197M1	–
	50	18,5	15	300 × 250 × 150	B250-41600-197N1	B250-41600-197M1	–
	63	22	18,5	300 × 250 × 150	B263-41600-197N1	B263-41600-197M1	–
	63	22	18,5	300 × 250 × 150	H406-41600-197N1*	H406-41600-197M1*	–
	80	30	22	300 × 250 × 150	H408-41600-197N1	H408-41600-197M1	–
	100	37	30	300 × 250 × 150	H410-41600-197N1	H410-41600-197M1	–
125	45	37	300 × 250 × 150	H412-41600-197N1	H412-41600-197M1	–	
41800 – 8-polig – ohne Hilfskontakte – 2 Neutralleiter voreilend 	20	5,5	3,7	200 × 150 × 120	H216-41800-197N1	H216-41800-197M1	H216-41800-197V1
	25	7,5	5,5	200 × 150 × 120	H220-41800-197N1	H220-41800-197M1	H220-41800-197V1
	32	11	7,5	200 × 150 × 120	H226-41800-197N1	H226-41800-197M1	H226-41800-197V1
	40	15	11	200 × 150 × 120	H233-41800-197N1	H233-41800-197M1	H233-41800-197V1
	40	15	11	300 × 250 × 150	B240-41800-197N1	B240-41800-197M1	–
	50	18,5	15	300 × 250 × 150	B250-41800-197N1	B250-41800-197M1	–
	63	22	18,5	300 × 250 × 150	B263-41800-197N1	B263-41800-197M1	–
	63	22	18,5	300 × 250 × 150	H406-41800-197N1*	H406-41800-197M1*	–
	80	30	22	300 × 250 × 150	H408-41800-197N1	H408-41800-197M1	–
	100	37	30	300 × 250 × 150	H410-41800-197N1	H410-41800-197M1	–
125	45	37	300 × 250 × 150	H412-41800-197N1	H412-41800-197M1	–	

* größerer Anschlussquerschnitt, siehe Seite 154

Weitere Schaltprogramme ab Seite 132.

Abmessungen in mm:

Aufbau der Bestellnummer		
Typ	Schaltprogramm	Bauform
B263	41800	197V1
Best.-Nr.	B263-41800-197V1	

Zugehörige Befestigungslaschen bitte getrennt bestellen, siehe Seite 148.

Typen H216 / H220 / H226 / H233:

Bauform	H1	B1	T1	T2	H2	B2
097M1	150	150	120	38	132	85
097N1	150	150	120	33	132	85
097V1	150	150	120	39	132	85
197M1	200	150	120	38	182	85
197N1	200	150	120	33	182	85
197V1	200	150	120	39	182	85

Typen B240 / B250 / B263:

Bauform	H1	B1	T1	T2	H2	B2
097M1	200	150	120	38	182	85
097N1	200	150	120	33	182	85
097V1	200	150	120	39	182	85
197M1	300	250	150	50	282	185
197N1	300	250	150	45	282	185

Typen H406 / H408 / H410 / H412:

Bauform	H1	B1	T1	T2	H2	B2
197M1	300	250	150	50	282	185
197N1	300	250	150	45	282	185
997M1	200	150	120	50	182	85
997N1	200	150	120	45	182	85



Lasttrennschalter

Ein-/Ausschalter Fronteinbau Vierlochbefestigung

Ein-/Ausschalter

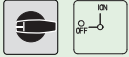

- Fronteinbauswitcher mit Vierlochbefestigung
- 3- bis 8-polig
- 20 A bis 315 A
- IP66 / IP55

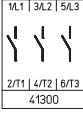

Schaltprogramm	Bemessungsdaten (IEC 60947) Betriebsstrom I_e Betriebsleistung (bei 380–440 V)			Befestigungsmaß (mm)	M-Griff silber/schwarz	G-Griff silber/schwarz
	AC-21A (A)	AC-23A (kW)	AC-3 (kW)		 IP66	 IP55
					Bestellnummer	Bestellnummer
41300 – 3-polig – ohne Hilfskontakte 	20	5,5	3,7	36 × 36	H216-41300-003M1	–
	20	5,5	3,7	48 × 48	H216-41300-013M1	–
	25	7,5	5,5	36 × 36	H220-41300-003M1	–
	25	7,5	5,5	48 × 48	H220-41300-013M1	–
	32	11	7,5	36 × 36	H226-41300-003M1	–
	32	11	7,5	48 × 48	H226-41300-013M1	–
	40	15	11	36 × 36	H233-41300-003M1	–
	40	15	11	36 × 36	B240-41300-003M1*	–
	40	15	11	48 × 48	H233-41300-013M1	–
	40	15	11	48 × 48	B240-41300-013M1*	–
	50	18,5	15	36 × 36	B250-41300-003M1	–
	50	18,5	15	48 × 48	B250-41300-013M1	–
	63	22	18,5	36 × 36	B263-41300-003M1	–
	63	22	18,5	48 × 48	B263-41300-013M1	–
	63	22	18,5	48 × 48	H406-41300-003M1*	–
	63	22	18,5	68 × 68	H406-41300-013M1	–
	80	30	22	48 × 48	H408-41300-003M1	–
	80	30	22	68 × 68	H408-41300-013M1	–
	100	37	30	48 × 48	H410-41300-003M1	–
	100	37	30	68 × 68	H410-41300-013M1	–
125	45	37	48 × 48	H412-41300-003M1	–	
125	45	37	68 × 68	H412-41300-013M1	–	
160	75	45	68 × 68	–	K616-41300-003G1	
160	75	45	104 × 104	–	K616-41300-013G1	
315	132	55	104 × 104	–	K830-41300-003G1	

* größerer Anschlussquerschnitt, siehe Seite 154

Weitere Schaltprogramme ab Seite 132.

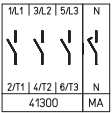

Schaltprogramm	Bemessungsdaten (IEC 60947) Betriebsstrom I_e Betriebsleistung (bei 380–440 V)			Befestigungsmaß (mm)	M-Griff silber/schwarz	G-Griff silber/schwarz	
	AC-21A (A)	AC-23A (kW)	AC-3 (kW)				
					IP66	IP55	
				Bestellnummer	Bestellnummer		
41400 – 4-polig – ohne Hilfskontakte – Neutralleiter voreilend 	20	5,5	3,7	36 × 36	H216-41400-003M1	–	
	20	5,5	3,7	48 × 48	H216-41400-013M1	–	
	25	7,5	5,5	36 × 36	H220-41400-003M1	–	
	25	7,5	5,5	48 × 48	H220-41400-013M1	–	
	32	11	7,5	36 × 36	H226-41400-003M1	–	
	32	11	7,5	48 × 48	H226-41400-013M1	–	
	40	15	11	36 × 36	H233-41400-003M1	–	
	40	15	11	36 × 36	B240-41400-003M1*	–	
	40	15	11	48 × 48	H233-41400-013M1	–	
	40	15	11	48 × 48	B240-41400-013M1*	–	
	50	18,5	15	36 × 36	B250-41400-003M1	–	
	50	18,5	15	48 × 48	B250-41400-013M1	–	
	63	22	18,5	36 × 36	B263-41400-003M1	–	
	63	22	18,5	48 × 48	B263-41400-013M1	–	
	63	22	18,5	48 × 48	H406-41400-003M1*	–	
	63	22	18,5	68 × 68	H406-41400-013M1	–	
	80	30	22	48 × 48	H408-41400-003M1	–	
	80	30	22	68 × 68	H408-41400-013M1	–	
	100	37	30	48 × 48	H410-41400-003M1	–	
	100	37	30	68 × 68	H410-41400-013M1	–	
	125	45	37	48 × 48	H412-41400-003M1	–	
125	45	37	68 × 68	H412-41400-013M1	–		
160	75	45	68 × 68	–	K616-41400-003G1		
160	75	45	104 × 104	–	K616-41400-013G1		
315	132	55	104 × 104	–	K830-41400-003G1		

* größerer Anschlussquerschnitt, siehe Seite 154

Weitere Schaltprogramme ab Seite 132.

Lasttrennschalter

Ein-/Ausschalter Fronteinbau Vierlochbefestigung

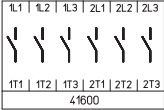
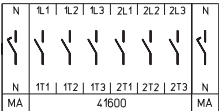
Schaltprogramm	Bemessungsdaten (IEC 60947) Betriebs- Betriebsleistung strom I _e (bei 380–440 V)			Befestigungsmaß (mm)	M-Griff silber/schwarz  IP66	G-Griff silber/schwarz  IP55	
	AC-21A (A)	AC-23A (kW)	AC-3 (kW)		Bestellnummer	Bestellnummer	
41600 – 6-polig – ohne Hilfskontakte 	20	5,5	3,7	48 × 48	H216-41600-013M1	–	
	25	7,5	5,5	48 × 48	H220-41600-013M1	–	
	32	11	7,5	48 × 48	H226-41600-013M1	–	
	40	15	11	48 × 48	H233-41600-013M1	–	
	40	15	11	48 × 48	B240-41600-013M1*	–	
	50	18,5	15	48 × 48	B250-41600-013M1	–	
	63	22	18,5	48 × 48	B263-41600-013M1	–	
	63	22	18,5	48 × 48	H406-41600-003M1*	–	
	63	22	18,5	68 × 68	H406-41600-013M1	–	
	80	30	22	48 × 48	H408-41600-003M1	–	
	80	30	22	68 × 68	H408-41600-013M1	–	
	100	37	30	48 × 48	H410-41600-003M1	–	
	100	37	30	68 × 68	H410-41600-013M1	–	
	125	45	37	48 × 48	H412-41600-003M1	–	
	125	45	37	68 × 68	H412-41600-013M1	–	
	160	75	45	68 × 68	–	K616-41600-003G1	
	160	75	45	104 × 104	–	K616-41600-013G1	
	315	132	55	104 × 104	–	K830-41600-003G1	
41800 – 8-polig – ohne Hilfskontakte – 2 Neutralleiter voreilend 	20	5,5	3,7	48 × 48	H216-41800-013M1	–	
	25	7,5	5,5	48 × 48	H220-41800-013M1	–	
	32	11	7,5	48 × 48	H226-41800-013M1	–	
	40	15	11	48 × 48	H233-41800-013M1	–	
	40	15	11	48 × 48	B240-41800-013M1*	–	
	50	18,5	15	48 × 48	B250-41800-013M1	–	
	63	22	18,5	48 × 48	B263-41800-013M1	–	
	63	22	18,5	48 × 48	H406-41800-003M1*	–	
	63	22	18,5	68 × 68	H406-41800-013M1	–	
	80	30	22	48 × 48	H408-41800-003M1	–	
	80	30	22	68 × 68	H408-41800-013M1	–	
	100	37	30	48 × 48	H410-41800-003M1	–	
	100	37	30	68 × 68	H410-41800-013M1	–	
	125	45	37	48 × 48	H412-41800-003M1	–	
	125	45	37	68 × 68	H412-41800-013M1	–	
	160	75	45	68 × 68	–	K616-41800-003G1	
	160	75	45	104 × 104	–	K616-41800-013G1	
	315	132	55	104 × 104	–	K830-41800-003G1	

* größerer Anschlussquerschnitt, siehe Seite 154

Weitere Schaltprogramme ab Seite 132.

Abmessungen in mm:

Aufbau der Bestellnummer		
Typ	Schaltprogramm	Bauform
H406	41800	013M1
Best.-Nr. H406-41800-013M1		

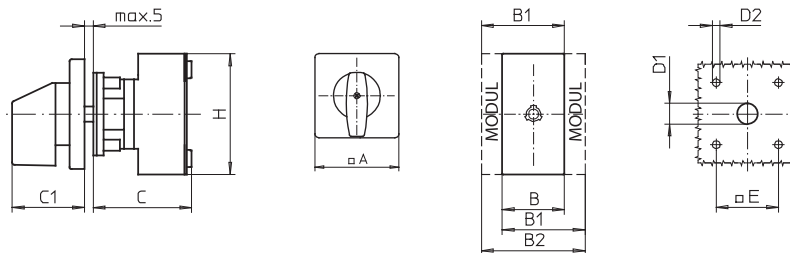

Schaltprogramme 3- und 4-polig

Typen H216 / H220 / H226 / H233:

Bauform	A	B	B1	B2	C	C1	D1	D2	E	H
003M1	48	36	48	60	58	32	12	4,5	36	70
013M1	64	36	48	60	58	39	15	5	48	70

Typen B240 / B250 / B263:

Bauform	A	B	B1	B2	C	C1	D1	D2	E	H
003M1	48	50	69	88	58	32	12	4,5	36	72
013M1	64	50	69	88	58	39	15	5	48	72

Typen H406 / H408 / H410 / H412:

Bauform	A	B	B1	B2	C	C1	D1	D2	E	H
003M1	64	70	89	108	73	39	15	5	48	80
013M1	88	70	89	108	73	52	15	5,5	68	80

Schaltprogramme 6- und 8-polig

Typen H216 / H220 / H226 / H233:

Bauform	A	B	B1	B2	C	C1	D1	D2	E	H
013M1	64	72	84	96	66	39	15	5	48	70

Typen B240 / B250 / B263:

Bauform	A	B	B1	B2	C	C1	D1	D2	E	H
013M1	64	100	119	138	70	39	15	5	48	72

Typen H406 / H408 / H410 / H412:

Bauform	A	B	B1	B2	C	C1	D1	D2	E	H
003M1	64	140	159	178	86	39	15	5	48	80
013M1	88	140	159	178	86	52	15	5,5	68	80

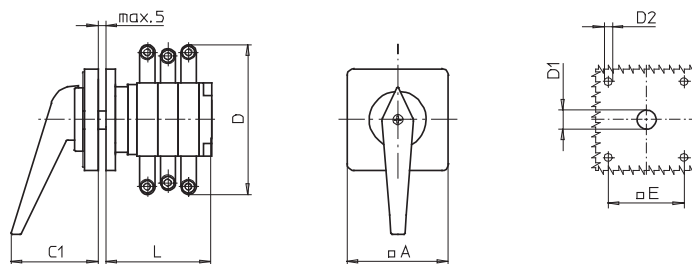

Typ K616:

Bauform	Schaltprogramm	A	C1	D*	D1	D2	E	L
003G1	41300	88	66	150	20	5,5	68	104
003G1	41400	88	66	150	20	5,5	68	104
013G1	41300	130	74	150	20	5,5	104	104
013G1	41400	130	74	150	20	5,5	104	104

Typ K830:

Bauform	Schaltprogramm	A	C1	D*	D1	D2	E	L
003G1	41300	130	74	210	20	5,5	104	125
003G1	41400	130	74	210	20	5,5	104	125

Typ K616:

Bauform	Schaltprogramm	A	C1	D*	D1	D2	E	L
003G1	41600	88	66	150	20	5,5	68	136
003G1	41800	88	66	150	20	5,5	68	168
013G1	41600	130	74	150	20	5,5	104	136
013G1	41800	130	74	150	20	5,5	104	168

Typ K830:

Bauform	Schaltprogramm	A	C1	D*	D1	D2	E	L
003G1	41600	130	74	210	20	5,5	104	161
003G1	41800	130	74	210	20	5,5	104	197

Weitere Schaltprogramme und zugehörige Abmessungen für Typen K auf Anfrage.

* einschließlich Anschlusswinkel



Lasttrennschalter

Ein-/Ausschalter Fronteinbau Zentralbefestigung

Ein-/Ausschalter

- Fronteinbauschalter mit Zentralbefestigung
- 3- bis 4-polig
- 20 A bis 63 A
- IP66

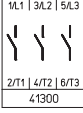
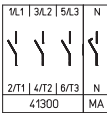

Schaltprogramm	Bemessungsdaten (IEC 60947) Betriebs- Betriebsleistung strom I _e (bei 380–440 V)			Befestigungsmaß (mm)	M-Griff silber/schwarz	M-Griff mit Frontring schwarz/schwarz
	AC-21A (A)	AC-23A (kW)	AC-3 (kW)		 IP66	 IP66
					Bestellnummer	Bestellnummer
41300 – 3-polig – ohne Hilfskontakte 	20	5,5	3,7	∅ 22,5	H216-41300-219M1	H216-41300-218M1
	20	5,5	3,7	∅ 30,5	H216-41300-209M1	H216-41300-208M1
	25	7,5	5,5	∅ 22,5	H220-41300-219M1	H220-41300-218M1
	25	7,5	5,5	∅ 30,5	H220-41300-209M1	H220-41300-208M1
	32	11	7,5	∅ 22,5	H226-41300-219M1	H226-41300-218M1
	32	11	7,5	∅ 30,5	H226-41300-209M1	H226-41300-208M1
	40	15	11	∅ 22,5	H233-41300-219M1	H233-41300-218M1
	40	15	11	∅ 22,5	B240-41300-219M1*	B240-41300-218M1*
	40	15	11	∅ 30,5	H233-41300-209M1	H233-41300-208M1
	40	15	11	∅ 30,5	B240-41300-209M1*	B240-41300-208M1*
	50	18,5	15	∅ 22,5	B250-41300-219M1	B250-41300-218M1
	50	18,5	15	∅ 30,5	B250-41300-209M1	B250-41300-208M1
	63	22	18,5	∅ 22,5	B263-41300-219M1	B263-41300-218M1
	63	22	18,5	∅ 30,5	B263-41300-209M1	B263-41300-208M1
41400 – 4-polig – ohne Hilfskontakte – Neutralleiter voreilend 	20	5,5	3,7	∅ 22,5	H216-41400-219M1	H216-41400-218M1
	20	5,5	3,7	∅ 30,5	H216-41400-209M1	H216-41400-208M1
	25	7,5	5,5	∅ 22,5	H220-41400-219M1	H220-41400-218M1
	25	7,5	5,5	∅ 30,5	H220-41400-209M1	H220-41400-208M1
	32	11	7,5	∅ 22,5	H226-41400-219M1	H226-41400-218M1
	32	11	7,5	∅ 30,5	H226-41400-209M1	H226-41400-208M1
	40	15	11	∅ 22,5	H233-41400-219M1	H233-41400-218M1
	40	15	11	∅ 22,5	B240-41400-219M1*	B240-41400-218M1*
	40	15	11	∅ 30,5	H233-41400-209M1	H233-41400-208M1
	40	15	11	∅ 30,5	B240-41400-209M1*	B240-41400-208M1*
	50	18,5	15	∅ 22,5	B250-41400-219M1	B250-41400-218M1
	50	18,5	15	∅ 30,5	B250-41400-209M1	B250-41400-208M1
	63	22	18,5	∅ 22,5	B263-41400-219M1	B263-41400-218M1
	63	22	18,5	∅ 30,5	B263-41400-209M1	B263-41400-208M1

* größerer Anschlussquerschnitt, siehe Seite 154

Weitere Schaltprogramme ab Seite 132.

Abmessungen in mm:

Aufbau der Bestellnummer

Typ	Schaltprogramm	Bauform
H226	41300	219M1
Best.-Nr. H226-41300-219M1		

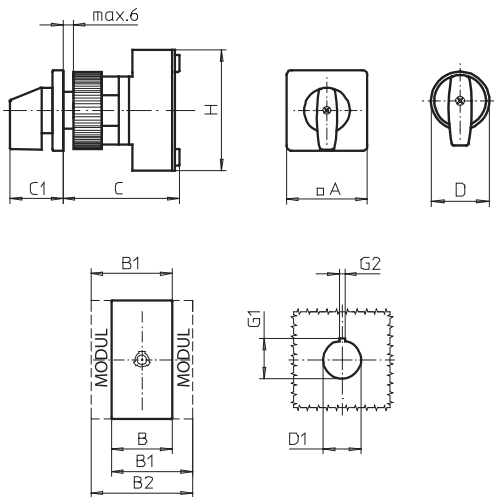

Typen H216 / H220 / H226 / H233:

Bauform	A	B	B1	B2	C	C1	D	D1	G1	G2	H
208M1	-	36	48	60	75	32	39,5	30,5	33	4,8	70
209M1	48	36	48	60	75	32	-	30,5	33	4,8	70
218M1	-	36	48	60	75	31,5	31	22,5	24,2	3,2	70
219M1	48	36	48	60	75	32	-	22,5	24,2	3,2	70

Typen B240 / B250 / B263:

Bauform	A	B	B1	B2	C	C1	D	D1	G1	G2	H
208M1	-	50	69	88	75	32	39,5	30,5	33	4,8	72
209M1	48	50	69	88	75	32	-	30,5	33	4,8	72
218M1	-	50	69	88	75	31,5	31	22,5	24,2	3,2	72
219M1	48	50	69	88	75	32	-	22,5	24,2	3,2	72





Lasttrennschalter

Ein-/Ausschalter Bodeneinbau Schnappbefestigung für Installationsverteiler

Ein-/Ausschalter

- Bodeneinbauschalter mit Schnappbefestigung
- für Installationsverteiler
- 3- bis 8-polig
- 20 A bis 125 A
- IP30

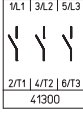

Schaltprogramm	Bemessungsdaten (IEC 60947) Betriebs- Betriebsleistung strom I _e (bei 380–440 V)			Frontschildmaß für Normausschnitt 45 mm (H × B) (mm)	M-Griff silber/schwarz   IP30	N-Griff silber/grau   IP30	
	AC-21A (A)	AC-23A (kW)	AC-3 (kW)		Bestellnummer	Bestellnummer	
41300 – 3-polig – ohne Hilfskontakte 	20	5,5	3,7	45 × 48	H216-41300-026M1	H216-41300-026N2	
	20	5,5	3,7	45 × 60	H216-41300-126M1	–	
	25	7,5	5,5	45 × 48	H220-41300-026M1	H220-41300-026N2	
	25	7,5	5,5	45 × 60	H220-41300-126M1	–	
	32	11	7,5	45 × 48	H226-41300-026M1	H226-41300-026N2	
	32	11	7,5	45 × 60	H226-41300-126M1	–	
	40	15	11	45 × 48	H233-41300-026M1	H233-41300-026N2	
	40	15	11	45 × 60	H233-41300-126M1	–	
	40	15	11	45 × 52,5	B240-41300-026M1*	B240-41300-026N2*	
	50	18,5	15	45 × 52,5	B250-41300-026M1	B250-41300-026N2	
	63	22	18,5	45 × 52,5	B263-41300-026M1	B263-41300-026N2	
	63	22	18,5	45 × 72	H406-41300-126M1*	–	
	80	30	22	45 × 72	H408-41300-126M1	–	
	100	37	30	45 × 72	H410-41300-126M1	–	
125	45	37	45 × 72	H412-41300-126M1	–		

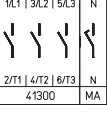
41400 – 4-polig – ohne Hilfskontakte – Neutralleiter voreilend 	20	5,5	3,7	45 × 48	H216-41400-026M1	H216-41400-026N2	
	20	5,5	3,7	45 × 60	H216-41400-126M1	–	
	25	7,5	5,5	45 × 48	H220-41400-026M1	H220-41400-026N2	
	25	7,5	5,5	45 × 60	H220-41400-126M1	–	
	32	11	7,5	45 × 48	H226-41400-026M1	H226-41400-026N2	
	32	11	7,5	45 × 60	H226-41400-126M1	–	
	40	15	11	45 × 48	H233-41400-026M1	H233-41400-026N2	
	40	15	11	45 × 60	H233-41400-126M1	–	
	40	15	11	45 × 52,5	B240-41400-026M1*	B240-41400-026N2*	
	50	18,5	15	45 × 52,5	B250-41400-026M1	B250-41400-026N2	
	63	22	18,5	45 × 52,5	B263-41400-026M1	B263-41400-026N2	
	63	22	18,5	45 × 72	H406-41400-126M1*	–	
	80	30	22	45 × 72	H408-41400-126M1	–	
	100	37	30	45 × 72	H410-41400-126M1	–	
125	45	37	45 × 72	H412-41400-126M1	–		

* größerer Anschlussquerschnitt, siehe Seite 154

Weitere Schaltprogramme ab Seite 132.

Lasttrennschalter

Ein-/Ausschalter Bodeneinbau Schnappbefestigung für Installationsverteiler

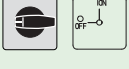
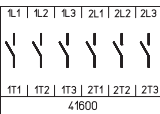
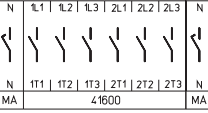
Schaltprogramm	Bemessungsdaten (IEC 60947) Betriebsstrom I_e Betriebsleistung (bei 380–440 V)			Frontschildmaß für Normausschnitt 45 mm (H × B) (mm)	M-Griff silber/schwarz  IP30	Bestellnummer
	AC-21A (A)	AC-23A (kW)	AC-3 (kW)			
41600 – 6-polig – ohne Hilfskontakte 	20	5,5	3,7	45 × 76	H216-41600-026M1	
	25	7,5	5,5	45 × 76	H220-41600-026M1	
	32	11	7,5	45 × 76	H226-41600-026M1	
	40	15	11	45 × 76	H233-41600-026M1	
	40	15	11	45 × 105	B240-41600-026M1*	
	50	18,5	15	45 × 105	B250-41600-026M1	
	63	22	18,5	45 × 105	B263-41600-026M1	
	63	22	18,5	45 × 72	H406-41600-126M1*	
	80	30	22	45 × 72	H408-41600-126M1	
	100	37	30	45 × 72	H410-41600-126M1	
	125	45	37	45 × 72	H412-41600-126M1	
41800 – 8-polig – ohne Hilfskontakte – 2 Neutralleiter voreilend 	20	5,5	3,7	45 × 76	H216-41800-026M1	
	25	7,5	5,5	45 × 76	H220-41800-026M1	
	32	11	7,5	45 × 76	H226-41800-026M1	
	40	15	11	45 × 76	H233-41800-026M1	
	40	15	11	45 × 105	B240-41800-026M1*	
	50	18,5	15	45 × 105	B250-41800-026M1	
	63	22	18,5	45 × 105	B263-41800-026M1	
	63	22	18,5	45 × 72	H406-41800-126M1*	
	80	30	22	45 × 72	H408-41800-126M1	
	100	37	30	45 × 72	H410-41800-126M1	
	125	45	37	45 × 72	H412-41800-126M1	

* größerer Anschlussquerschnitt, siehe Seite 154
Weitere Schaltprogramme ab Seite 132.

Abmessungen in mm:

Aufbau der Bestellnummer

Typ	Schaltprogramm	Bauform
H220	41400	026M1
Best.-Nr.	H220-41400-026M1	

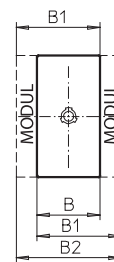
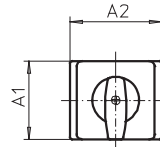
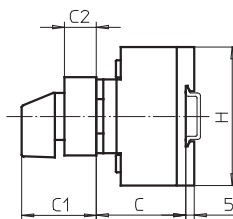

Schaltprogramme 3- und 4-polig

Typen H216 / H220 / H226 / H233:

Bauform	A1	A2	B	B1	B2	C	C1	C2	H
026M1	45	48	36	48	60	38	45	18,5	70
026N2	45	48	36	48	60	38	40	18,5	70
126M1	45	60	36	48	60	38	45	18,5	70

Typen B240 / B250 / B263:

Bauform	A1	A2	B	B1	B2	C	C1	C2	H
026M1	45	52,5	50	69	88	38	45	18,5	72
026N2	45	52,5	50	69	88	38	40	18,5	72

Typen H406 / H408 / H410 / H412:

Bauform	A1	A2	B	B1	B2	C	C1	C2	H
126M1	45	72	70	89	108	55	48	16	80

Schaltprogramme 6- und 8-polig

Typen H216 / H220 / H226 / H233:

Bauform	A1	A2	B	B1	B2	C	C1	C2	H
026M1	45	76	72	84	96	40	51,5	25,5	70

Typen B240 / B250 / B263:

Bauform	A1	A2	B	B1	B2	C	C1	C2	H
026M1	45	105	100	119	138	40	51,5	25,5	72

Typen H406 / H408 / H410 / H412:

Bauform	A1	A2	B	B1	B2	C	C1	C2	H
126M1	45	72	140	159	178	67	48	16	80

Lasttrennschalter

Ein-/Ausschalter Bodeneinbau Schnappbefestigung mit Türverriegelung

Ein-/Ausschalter

- Bodeneinbauswitcher mit Schnappbefestigung
- Türverriegelung
- 3- bis 8-polig
- 20 A bis 125 A
- IP66
- mit Modular- bzw. Metallachsverlängerung
- Zentral- oder Vierlochbefestigung frontseitig



Bodeneinbauswitcher mit Schnappbefestigung und Türverriegelung werden in zwei Verlängerungsvarianten angeboten:

- Switcher mit **Modularachsverlängerung** können durch das Aufstecken zusätzlicher Module auf das benötigte Einbaumaß C verlängert werden. Die zugehörigen Verlängerungsbauteile finden Sie auf Seite 145.

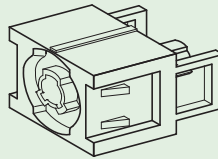
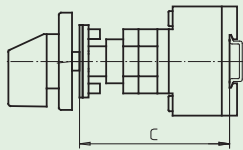

AVC2/AVC4
Modularachsverlängerung

- Bei Switchern mit **Metallachsverlängerung** ist die benötigte Metallachse nicht im Lieferumfang enthalten und muss getrennt bestellt werden. Angaben zum Einbaumaß C und zu den erhältlichen Ausführungen finden Sie auf Seite 146.

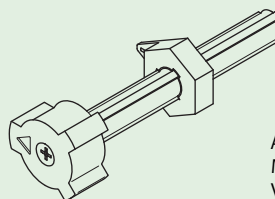
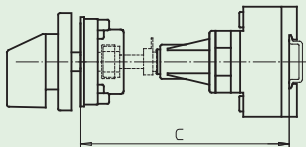

AVB8
Metallachsverlängerung für
Vierlochbefestigung (frontseitig)

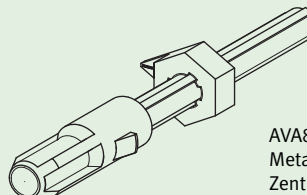
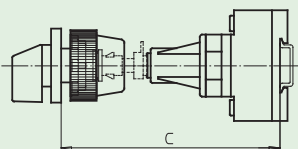

AVA8
Metallachsverlängerung für
Zentralbefestigung (frontseitig)

Schaltprogramm	Bemessungsdaten (IEC 60947) Betriebsstrom I_e Betriebsleistung (bei 380–440 V)			Befestigungsmaß (frontseitig)	M-Griff silber/schwarz	
	AC-21A (A)	AC-23A (kW)	AC-3 (kW)		(mm)	

41300
– 3-polig
– ohne Hilfskontakte

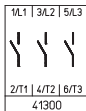

mit Modularachsverlängerung:

→ Verlängerungsbauteile siehe Seite 145!

20	5,5	3,7	36 × 36	H216-41300-242M1	
20	5,5	3,7	48 × 48	H216-41300-248M1	
25	7,5	5,5	36 × 36	H220-41300-242M1	
25	7,5	5,5	48 × 48	H220-41300-248M1	
32	11	7,5	36 × 36	H226-41300-242M1	
32	11	7,5	48 × 48	H226-41300-248M1	
40	15	11	36 × 36	H233-41300-242M1	
40	15	11	36 × 36	B240-41300-242M1*	
40	15	11	48 × 48	H233-41300-248M1	
40	15	11	48 × 48	B240-41300-248M1*	
50	18,5	15	36 × 36	B250-41300-242M1	
50	18,5	15	48 × 48	B250-41300-248M1	
63	22	18,5	36 × 36	B263-41300-242M1	
63	22	18,5	48 × 48	B263-41300-248M1	
63	22	18,5	48 × 48	H406-41300-242M1*	
80	30	22	48 × 48	H408-41300-242M1	
100	37	30	48 × 48	H410-41300-242M1	
125	45	37	48 × 48	H412-41300-242M1	

mit Metallachsverlängerung:

→ Zugehörige Metallachse getrennt bestellen, siehe Seite 146!

20	5,5	3,7	36 × 36	H216-41300-481M1	
20	5,5	3,7	48 × 48	H216-41300-482M1	
20	5,5	3,7	∅ 22,5	H216-41300-283M1	
25	7,5	5,5	36 × 36	H220-41300-481M1	
25	7,5	5,5	48 × 48	H220-41300-482M1	
25	7,5	5,5	∅ 22,5	H220-41300-283M1	
32	11	7,5	36 × 36	H226-41300-481M1	
32	11	7,5	48 × 48	H226-41300-482M1	
32	11	7,5	∅ 22,5	H226-41300-283M1	
40	15	11	36 × 36	H233-41300-481M1	
40	15	11	36 × 36	B240-41300-481M1*	
40	15	11	48 × 48	H233-41300-482M1	
40	15	11	48 × 48	B240-41300-482M1*	
40	15	11	∅ 22,5	H233-41300-283M1	
40	15	11	∅ 22,5	B240-41300-283M1*	
50	18,5	15	36 × 36	B250-41300-481M1	
50	18,5	15	48 × 48	B250-41300-482M1	
50	18,5	15	∅ 22,5	B250-41300-283M1	
63	22	18,5	36 × 36	B263-41300-481M1	
63	22	18,5	48 × 48	B263-41300-482M1	
63	22	18,5	48 × 48	H406-41300-481M1*	
63	22	18,5	∅ 22,5	B263-41300-283M1	
63	22	18,5	∅ 22,5	H406-41300-283M1*	
80	30	22	48 × 48	H408-41300-481M1	
80	30	22	∅ 22,5	H408-41300-283M1	
100	37	30	48 × 48	H410-41300-481M1	
100	37	30	∅ 22,5	H410-41300-283M1	
125	45	37	48 × 48	H412-41300-481M1	
125	45	37	∅ 22,5	H412-41300-283M1	

* größerer Anschlussquerschnitt, siehe Seite 154

Weitere Schaltprogramme ab Seite 132.

Lasttrennschalter

Ein-/Ausschalter Bodeneinbau Schnappbefestigung mit Türverriegelung

Schaltprogramm	Bemessungsdaten (IEC 60947) Betriebsstrom I_e Betriebsleistung (bei 380–440 V)			Befestigungsmaß (frontseitig)	M-Griff silber/schwarz	IP66
	AC-21A (A)	AC-23A (kW)	AC-3 (kW)		(mm)	
					Bestellnummer	

41400

- 4-polig
- ohne Hilfskontakte
- Neutralleiter voreilend

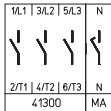

mit Modularachsverlängerung:

→ Verlängerungsbauteile siehe Seite 145!

20	5,5	3,7	36 x 36	H216-41400-242M1	
20	5,5	3,7	48 x 48	H216-41400-248M1	
25	7,5	5,5	36 x 36	H220-41400-242M1	
25	7,5	5,5	48 x 48	H220-41400-248M1	
32	11	7,5	36 x 36	H226-41400-242M1	
32	11	7,5	48 x 48	H226-41400-248M1	
40	15	11	36 x 36	H233-41400-242M1	
40	15	11	36 x 36	B240-41400-242M1*	
40	15	11	48 x 48	H233-41400-248M1	
40	15	11	48 x 48	B240-41400-248M1*	
50	18,5	15	36 x 36	B250-41400-242M1	
50	18,5	15	48 x 48	B250-41400-248M1	
63	22	18,5	36 x 36	B263-41400-242M1	
63	22	18,5	48 x 48	B263-41400-248M1	
63	22	18,5	48 x 48	H406-41400-242M1*	
80	30	22	48 x 48	H408-41400-242M1	
100	37	30	48 x 48	H410-41400-242M1	
125	45	37	48 x 48	H412-41400-242M1	

mit Metallachsverlängerung:

→ Zugehörige Metallachse getrennt bestellen, siehe Seite 146!

20	5,5	3,7	36 x 36	H216-41400-481M1	
20	5,5	3,7	48 x 48	H216-41400-482M1	
20	5,5	3,7	Ø 22,5	H216-41400-283M1	
25	7,5	5,5	36 x 36	H220-41400-481M1	
25	7,5	5,5	48 x 48	H220-41400-482M1	
25	7,5	5,5	Ø 22,5	H220-41400-283M1	
32	11	7,5	36 x 36	H226-41400-481M1	
32	11	7,5	48 x 48	H226-41400-482M1	
32	11	7,5	Ø 22,5	H226-41400-283M1	
40	15	11	36 x 36	H233-41400-481M1	
40	15	11	36 x 36	B240-41400-481M1*	
40	15	11	48 x 48	H233-41400-482M1	
40	15	11	48 x 48	B240-41400-482M1*	
40	15	11	Ø 22,5	H233-41400-283M1	
40	15	11	Ø 22,5	B240-41400-283M1*	
50	18,5	15	36 x 36	B250-41400-481M1	
50	18,5	15	48 x 48	B250-41400-482M1	
50	18,5	15	Ø 22,5	B250-41400-283M1	
63	22	18,5	36 x 36	B263-41400-481M1	
63	22	18,5	48 x 48	B263-41400-482M1	
63	22	18,5	48 x 48	H406-41400-481M1*	
63	22	18,5	Ø 22,5	B263-41400-283M1	
63	22	18,5	Ø 22,5	H406-41400-283M1*	
80	30	22	48 x 48	H408-41400-481M1	
80	30	22	Ø 22,5	H408-41400-283M1	
100	37	30	48 x 48	H410-41400-481M1	
100	37	30	Ø 22,5	H410-41400-283M1	
125	45	37	48 x 48	H412-41400-481M1	
125	45	37	Ø 22,5	H412-41400-283M1	

* größerer Anschlussquerschnitt, siehe Seite 154

Weitere Schaltprogramme ab Seite 132.

Schaltprogramm	Bemessungsdaten (IEC 60947) Betriebs- Betriebsleistung strom I_e (bei 380–440 V)			Befestigungsmaß (frontseitig)	M-Griff silber/schwarz	IP66
	AC-21A (A)	AC-23A (kW)	AC-3 (kW)		(mm)	
					Bestellnummer	

41600
– 6-polig
– ohne Hilfskontakte

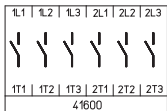

mit Modularachsverlängerung:

→ Verlängerungsbauteile siehe Seite 145!

20	5,5	3,7	48 x 48	H216-41600-248M1	
25	7,5	5,5	48 x 48	H220-41600-248M1	
32	11	7,5	48 x 48	H226-41600-248M1	
40	15	11	48 x 48	H233-41600-248M1	
40	15	11	48 x 48	B240-41600-248M1*	
50	18,5	15	48 x 48	B250-41600-248M1	
63	22	18,5	48 x 48	B263-41600-248M1	
63	22	18,5	48 x 48	H406-41600-242M1*	
80	30	22	48 x 48	H408-41600-242M1	
100	37	30	48 x 48	H410-41600-242M1	
125	45	37	48 x 48	H412-41600-242M1	

mit Metallachsverlängerung:

→ Zugehörige Metallachse getrennt bestellen, siehe Seite 146!

20	5,5	3,7	48 x 48	H216-41600-482M1	
20	5,5	3,7	∅ 22,5	H216-41600-285M1	
25	7,5	5,5	48 x 48	H220-41600-482M1	
25	7,5	5,5	∅ 22,5	H220-41600-285M1	
32	11	7,5	48 x 48	H226-41600-482M1	
32	11	7,5	∅ 22,5	H226-41600-285M1	
40	15	11	48 x 48	H233-41600-482M1	
40	15	11	48 x 48	B240-41600-482M1*	
40	15	11	∅ 22,5	H233-41600-285M1	
40	15	11	∅ 22,5	B240-41600-285M1*	
50	18,5	15	48 x 48	B250-41600-482M1	
50	18,5	15	∅ 22,5	B250-41600-285M1	
63	22	18,5	48 x 48	B263-41600-482M1	
63	22	18,5	48 x 48	H406-41600-481M1*	
63	22	18,5	∅ 22,5	B263-41600-285M1	
63	22	18,5	∅ 22,5	H406-41600-283M1*	
80	30	22	48 x 48	H408-41600-481M1	
80	30	22	∅ 22,5	H408-41600-283M1	
100	37	30	48 x 48	H410-41600-481M1	
100	37	30	∅ 22,5	H410-41600-283M1	
125	45	37	48 x 48	H412-41600-481M1	
125	45	37	∅ 22,5	H412-41600-283M1	

* größerer Anschlussquerschnitt, siehe Seite 154

Weitere Schaltprogramme ab Seite 132.

Lasttrennschalter

Ein-/Ausschalter Bodeneinbau Schnappbefestigung mit Türverriegelung

Schaltprogramm	Bemessungsdaten (IEC 60947) Betriebs- Betriebsleistung strom I_e (bei 380–440 V)			Befestigungsmaß (frontseitig)	M-Griff silber/schwarz	IP66
	AC-21A (A)	AC-23A (kW)	AC-3 (kW)		(mm)	
					Bestellnummer	

41800

- 8-polig
- ohne Hilfskontakte
- 2 Neutralleiter voreilend

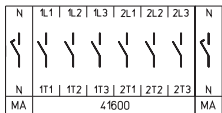

mit Modularachsverlängerung:

→ Verlängerungsbauteile siehe Seite 145!

20	5,5	3,7	48 x 48	H216-41800-248M1	
25	7,5	5,5	48 x 48	H220-41800-248M1	
32	11	7,5	48 x 48	H226-41800-248M1	
40	15	11	48 x 48	H233-41800-248M1	
40	15	11	48 x 48	B240-41800-248M1*	
50	18,5	15	48 x 48	B250-41800-248M1	
63	22	18,5	48 x 48	B263-41800-248M1	
63	22	18,5	48 x 48	H406-41800-242M1*	
80	30	22	48 x 48	H408-41800-242M1	
100	37	30	48 x 48	H410-41800-242M1	
125	45	37	48 x 48	H412-41800-242M1	

mit Metallachsverlängerung:

→ Zugehörige Metallachse getrennt bestellen, siehe Seite 146!

20	5,5	3,7	48 x 48	H216-41800-482M1	
20	5,5	3,7	∅ 22,5	H216-41800-285M1	
25	7,5	5,5	48 x 48	H220-41800-482M1	
25	7,5	5,5	∅ 22,5	H220-41800-285M1	
32	11	7,5	48 x 48	H226-41800-482M1	
32	11	7,5	∅ 22,5	H226-41800-285M1	
40	15	11	48 x 48	H233-41800-482M1	
40	15	11	48 x 48	B240-41800-482M1*	
40	15	11	∅ 22,5	H233-41800-285M1	
40	15	11	∅ 22,5	B240-41800-285M1*	
50	18,5	15	48 x 48	B250-41800-482M1	
50	18,5	15	∅ 22,5	B250-41800-285M1	
63	22	18,5	48 x 48	B263-41800-482M1	
63	22	18,5	48 x 48	H406-41800-481M1*	
63	22	18,5	∅ 22,5	B263-41800-285M1	
63	22	18,5	∅ 22,5	H406-41800-283M1*	
80	30	22	48 x 48	H408-41800-481M1	
80	30	22	∅ 22,5	H408-41800-283M1	
100	37	30	48 x 48	H410-41800-481M1	
100	37	30	∅ 22,5	H410-41800-283M1	
125	45	37	48 x 48	H412-41800-481M1	
125	45	37	∅ 22,5	H412-41800-283M1	

* größerer Anschlussquerschnitt, siehe Seite 154

Weitere Schaltprogramme ab Seite 132.

Abmessungen in mm:

Türverriegelung mit **Modularachsverlängerung**: Vierlochbefestigung (frontseitig)

Aufbau der Bestellnummer		
Typ	Schaltprogramm	Bauform
H412	41800	242M1
Best.-Nr.	H412-41800-242M1	

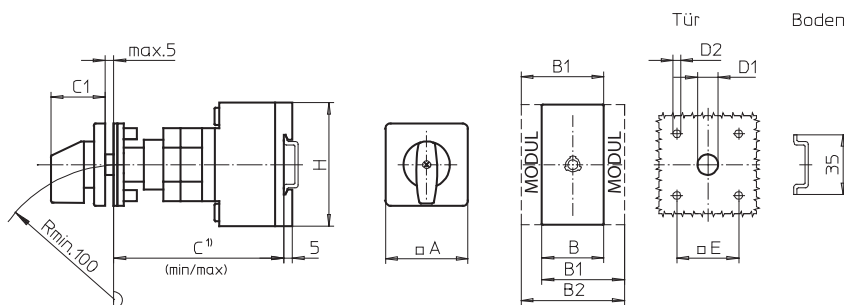

¹⁾ Einbaumaß: Innenseite Tür bis Oberkante Tragschiene, Abmessungen mit Verlängerung siehe Seite 145.

Schaltprogramme 3- und 4-polig

Typen H216 / H220 / H226 / H233:

Bauform	A	B	B1	B2	C _{min}	C _{max}	C1	D1	D2	E	H
242M1	48	36	48	60	92	107	32	12	4,5	36	70
248M1	64	36	48	60	92	107	39	15	5	48	70

Typen B240 / B250 / B263:

Bauform	A	B	B1	B2	C _{min}	C _{max}	C1	D1	D2	E	H
242M1	48	50	69	88	92	107	32	12	4,5	36	72
248M1	64	50	69	88	92	107	39	15	5	48	72

Typen H406 / H408 / H410 / H412:

Bauform	A	B	B1	B2	C _{min}	C _{max}	C1	D1	D2	E	H
242M1	64	70	89	108	102	117	40	15	5	48	80

Schaltprogramme 6- und 8-polig

Typen H216 / H220 / H226 / H233:

Bauform	A	B	B1	B2	C _{min}	C _{max}	C1	D1	D2	E	H
248M1	64	72	84	96	100	115	39	15	5	48	70

Typen B240 / B250 / B263:

Bauform	A	B	B1	B2	C _{min}	C _{max}	C1	D1	D2	E	H
248M1	64	100	119	138	104	119	39	15	5	48	72

Typen H406 / H408 / H410 / H412:

Bauform	A	B	B1	B2	C _{min}	C _{max}	C1	D1	D2	E	H
242M1	64	140	159	178	115	130	40	15	5	48	80

Lasttrennschalter

Ein-/Ausschalter **Bodeneinbau** Schnappbefestigung mit Türverriegelung

Abmessungen in mm:

Türverriegelung mit **Metallachsverlängerung**: Vierlochbefestigung (frontseitig)

Aufbau der Bestellnummer		
Typ	Schaltprogramm	Bauform
H226	41400	481M1
Best.-Nr. H226-41400-481M1		

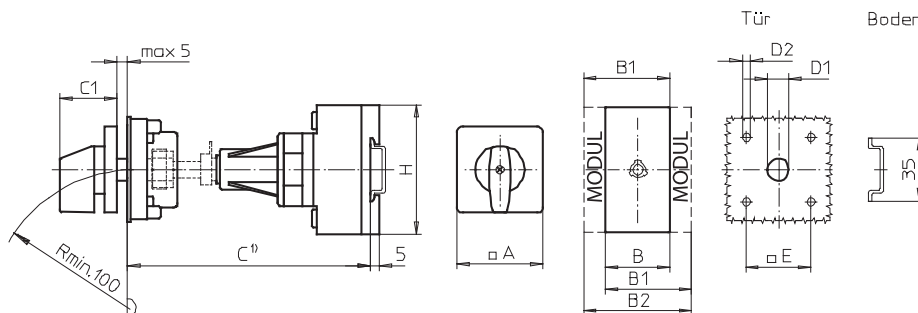

¹⁾ Einbaumaß: Innenseite Tür bis Oberkante Tragschiene, Abmessungen siehe Seite 146.

Schaltprogramme 3- und 4-polig

Typen H216 / H220 / H226 / H233:

Bauform	A	B	B1	B2	C1	D1	D2	E	H
481M1	48	36	48	60	32	15	4,5	36	70
482M1	64	36	48	60	39	15	5	48	70

Typen B240 / B250 / B263:

Bauform	A	B	B1	B2	C1	D1	D2	E	H
481M1	48	50	69	88	32	15	4,5	36	72
482M1	64	50	69	88	39	15	5	48	72

Typen H406 / H408 / H410 / H412:

Bauform	A	B	B1	B2	C1	D1	D2	E	H
481M1	64	70	89	108	40	15	5	48	80

Schaltprogramme 6- und 8-polig

Typen H216 / H220 / H226 / H233:

Bauform	A	B	B1	B2	C1	D1	D2	E	H
482M1	64	72	84	96	39	15	5	48	70

Typen B240 / B250 / B263:

Bauform	A	B	B1	B2	C1	D1	D2	E	H
482M1	64	100	119	138	39	15	5	48	72

Typen H406 / H408 / H410 / H412:

Bauform	A	B	B1	B2	C1	D1	D2	E	H
481M1	64	140	159	178	40	15	5	48	80

Abmessungen in mm:

Türverriegelung mit **Metallachsverlängerung**: Zentralbefestigung (frontseitig)

Aufbau der Bestellnummer		
Typ	Schaltprogramm	Bauform
B250	41400	283M1
Best.-Nr. B250-41400-283M1		

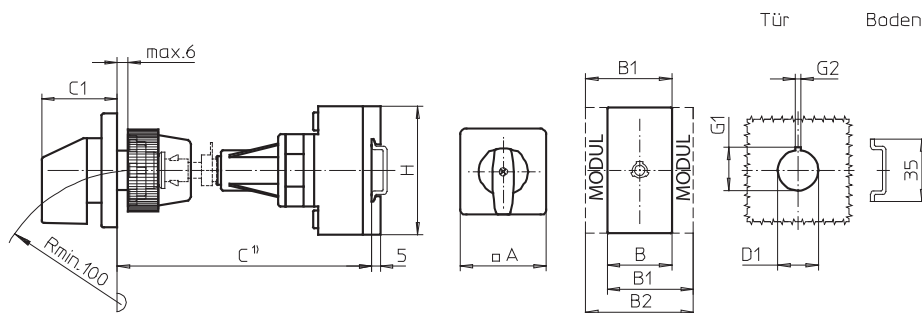

¹⁾ Einbaumaß: Außenseite Tür bis Oberkante Tragschiene, Abmessungen siehe Seite 146.

Schaltprogramme 3- und 4-polig

Typen H216 / H220 / H226 / H233:

Bauform	A	B	B1	B2	C1	D1	G1	G2	H
283M1	48	36	48	60	32	22,5	24,2	3,2	70

Typen B240 / B250 / B263:

Bauform	A	B	B1	B2	C1	D1	G1	G2	H
283M1	48	50	69	88	32	22,5	24,2	3,2	72

Typen H406 / H408 / H410 / H412:

Bauform	A	B	B1	B2	C1	D1	G1	G2	H
283M1	64	70	89	108	39	22,5	24,2	3,2	80

Schaltprogramme 6- und 8-polig

Typen H216 / H220 / H226 / H233:

Bauform	A	B	B1	B2	C1	D1	G1	G2	H
285M1	64	72	84	96	39	22,5	24,2	3,2	70

Typen B240 / B250 / B263:

Bauform	A	B	B1	B2	C1	D1	G1	G2	H
285M1	64	100	119	138	39	22,5	24,2	3,2	72

Typen H406 / H408 / H410 / H412:

Bauform	A	B	B1	B2	C1	D1	G1	G2	H
283M1	64	140	159	178	39	22,5	24,2	3,2	80

Lasttrennschalter

Ein-/Ausschalter Bodeneinbau Vierlochbefestigung mit Türverriegelung

Ein-/Ausschalter

- Bodeneinbauschalter mit Vierlochbefestigung und Türverriegelung
- 3- bis 8-polig
- 160 A bis 315 A
- IP55



Schaltprogramm	Bemessungsdaten (IEC 60947) Betriebs- Betriebsleistung strom I _e (bei 380–440 V)			Befestigungsmaß (boden-/frontseitig) (mm)	G-Griff silber/schwarz  IP55	Bestellnummer
	AC-21A (A)	AC-23A (kW)	AC-3 (kW)			
41300 – 3-polig – ohne Hilfskontakte	160	75	45	68 × 68 / 68 × 68	K616-41300-042G1	
	315	132	55	104 × 104 / 104 × 104	K830-41300-042G1	

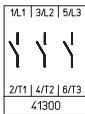

41400 – 4-polig – ohne Hilfskontakte – Neutralleiter voreilend	160	75	45	68 × 68 / 68 × 68	K616-41400-042G1	
	315	132	55	104 × 104 / 104 × 104	K830-41400-042G1	

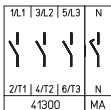

41600 – 6-polig – ohne Hilfskontakte	160	75	45	68 × 68 / 68 × 68	K616-41600-042G1	
	315	132	55	104 × 104 / 104 × 104	K830-41600-042G1	

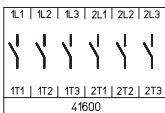

41800 – 8-polig – ohne Hilfskontakte – 2 Neutralleiter voreilend	160	75	45	68 × 68 / 68 × 68	K616-41800-042G1	
	315	132	55	104 × 104 / 104 × 104	K830-41800-042G1	

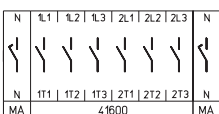

Abmessungen in mm:

Aufbau der Bestellnummer

Typ	Schaltprogramm	Bauform
K830	41300	042G1
Best.-Nr.	K830-41300-042G1	

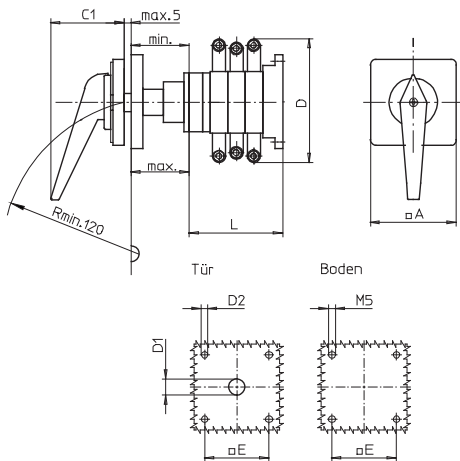

Typ K616:

Schaltprogramm	A	C1	D*	D1	D2	E	min	max	L
41300	88	66	150	15	5,5	68	48	60	104
41400	88	66	150	15	5,5	68	48	60	104
41600	88	66	150	15	5,5	68	48	60	136
41800	88	66	150	15	5,5	68	48	60	168

Typ K830:

Schaltprogramm	A	C1	D*	D1	D2	E	min	max	L
41300	130	74	210	20	5,5	104	75	102	125
41400	130	74	210	20	5,5	104	75	102	125
41600	130	74	210	20	5,5	104	75	102	161
41800	130	74	210	20	5,5	104	75	102	197

* einschließlich Anschlusswinkel

Weitere Schaltprogramme und zugehörige Abmessungen für Typen K auf Anfrage.

Lasttrennschalter

Ein-/Ausschalter Gekapselte Schalter mit Isolierstoffgehäuse

Ein-/Ausschalter

- Gekapselte Schalter mit Isolierstoffgehäuse (Polycarbonat)
- Deckelverriegelung in EIN-Stellung
- 3- bis 8-polig
- 20 A bis 125 A
- IP66

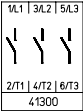

Schaltprogramm	Bemessungsdaten (IEC 60947) Betriebs- Betriebsleistung strom I _e (bei 380–440 V)			Gehäuse- abmessungen (H × B × T) (mm)	M-Griff silber/schwarz	IP66
	AC-21A (A)	AC-23A (kW)	AC-3 (kW)		Bestellnummer	
41300 – 3-polig – ohne Hilfskontakte 	20	5,5	3,7	125 × 100 × 85	H216-41300-701M1	
	20	5,5	3,7	175 × 115 × 100	H216-41300-711M1	
	20	5,5	3,7	250 × 160 × 120	H216-41300-731M1	
	25	7,5	5,5	125 × 100 × 85	H220-41300-701M1	
	25	7,5	5,5	175 × 115 × 100	H220-41300-711M1	
	25	7,5	5,5	250 × 160 × 120	H220-41300-731M1	
	32	11	7,5	125 × 100 × 85	H226-41300-701M1	
	32	11	7,5	175 × 115 × 100	H226-41300-711M1	
	32	11	7,5	250 × 160 × 120	H226-41300-731M1	
	40	15	11	175 × 115 × 100	H233-41300-711M1	
	40	15	11	175 × 115 × 100	B240-41300-711M1 * ¹	
	40	15	11	250 × 160 × 120	H233-41300-731M1	
	40	15	11	250 × 160 × 120	B240-41300-731M1 *	
	50	18,5	15	175 × 115 × 100	B250-41300-711M1 ¹	
	50	18,5	15	250 × 160 × 120	B250-41300-731M1	
	63	22	18,5	175 × 115 × 100	B263-41300-711M1 ¹	
	63	22	18,5	250 × 160 × 120	B263-41300-731M1	
	63	22	18,5	250 × 160 × 120	H406-41300-731M1 *	
	63	22	18,5	280 × 190 × 130	H406-41300-771M1	
	80	30	22	250 × 160 × 120	H408-41300-731M1	
80	30	22	280 × 190 × 130	H408-41300-771M1		
100	37	30	250 × 160 × 120	H410-41300-731M1		
100	37	30	280 × 190 × 130	H410-41300-771M1		

* größerer Anschlussquerschnitt, siehe Seite 154

¹ max. Anschlussquerschnitt 16 mm² an N- und/oder PE-Gehäuseklemme

Weitere Schaltprogramme ab Seite 132.

Schaltprogramm	Bemessungsdaten (IEC 60947) Betriebsstrom I_e Betriebsleistung (bei 380–440 V)			Gehäuse- abmessungen (H × B × T) (mm)	M-Griff silber/schwarz	Bestellnummer
	AC-21A (A)	AC-23A (kW)	AC-3 (kW)		IP66	
41400 – 4-polig – ohne Hilfskontakte – Neutralleiter voreilend 	20	5,5	3,7	125 × 100 × 85		H216-41400-701M1
	20	5,5	3,7	175 × 115 × 100		H216-41400-711M1
	20	5,5	3,7	250 × 160 × 120		H216-41400-731M1
	25	7,5	5,5	125 × 100 × 85		H220-41400-701M1
	25	7,5	5,5	175 × 115 × 100		H220-41400-711M1
	25	7,5	5,5	250 × 160 × 120		H220-41400-731M1
	32	11	7,5	125 × 100 × 85		H226-41400-701M1
	32	11	7,5	175 × 115 × 100		H226-41400-711M1
	32	11	7,5	250 × 160 × 120		H226-41400-731M1
	40	15	11	175 × 115 × 100		H233-41400-711M1
	40	15	11	175 × 115 × 100		B240-41400-711M1*¹
	40	15	11	250 × 160 × 120		H233-41400-731M1
	40	15	11	250 × 160 × 120		B240-41400-731M1*
	50	18,5	15	175 × 115 × 100		B250-41400-711M1¹
	50	18,5	15	250 × 160 × 120		B250-41400-731M1
	63	22	18,5	175 × 115 × 100		B263-41400-711M1¹
	63	22	18,5	250 × 160 × 120		B263-41400-731M1
	63	22	18,5	250 × 160 × 120		H406-41400-731M1*
	63	22	18,5	280 × 190 × 130		H406-41400-771M1
	80	30	22	250 × 160 × 120		H408-41400-731M1
80	30	22	280 × 190 × 130		H408-41400-771M1	
100	37	30	250 × 160 × 120		H410-41400-731M1	
100	37	30	280 × 190 × 130		H410-41400-771M1	



* größerer Anschlussquerschnitt, siehe Seite 154

¹ max. Anschlussquerschnitt 16 mm² an N- und/oder PE-Gehäuseklemme

Weitere Schaltprogramme ab Seite 132.

Lasttrennschalter

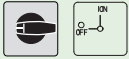
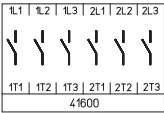
Ein-/Ausschalter Gekapselte Schalter mit Isolierstoffgehäuse

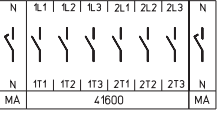
Schaltprogramm	Bemessungsdaten (IEC 60947) Betriebsstrom I_e Betriebsleistung (bei 380–440 V)			Gehäuse- abmessungen (H × B × T) (mm)	M-Griff silber/schwarz	Bestellnummer
	AC-21A (A)	AC-23A (kW)	AC-3 (kW)		 IP66	
41600 – 6-polig – ohne Hilfskontakte 	20	5,5	3,7	175 × 115 × 100		H216-41600-721M1
	20	5,5	3,7	250 × 160 × 120		H216-41600-734M1
	20	5,5	3,7	280 × 190 × 130		H216-41600-771M1
	25	7,5	5,5	175 × 115 × 100		H220-41600-721M1
	25	7,5	5,5	250 × 160 × 120		H220-41600-734M1
	25	7,5	5,5	280 × 190 × 130		H220-41600-771M1
	32	11	7,5	175 × 115 × 100		H226-41600-721M1
	32	11	7,5	250 × 160 × 120		H226-41600-734M1
	32	11	7,5	280 × 190 × 130		H226-41600-771M1
	40	15	11	175 × 115 × 100		H233-41600-721M1
	40	15	11	250 × 160 × 120		H233-41600-734M1
	40	15	11	280 × 190 × 130		H233-41600-771M1
	40	15	11	280 × 190 × 130		B240-41600-771M1 * ¹
	40	15	11	320 × 220 × 180		B240-41600-976M1
	50	18,5	15	280 × 190 × 130		B250-41600-771M1 ¹
	50	18,5	15	320 × 220 × 180		B250-41600-976M1
	63	22	18,5	280 × 190 × 130		B263-41600-771M1 ¹
	63	22	18,5	320 × 220 × 180		B263-41600-976M1
	63	22	18,5	440 × 320 × 180		H406-41600-578M1
	80	30	22	440 × 320 × 180		H408-41600-578M1
100	37	30	440 × 320 × 180		H410-41600-578M1	
125	45	37	440 × 320 × 180		H412-41600-578M1	
41800 – 8-polig – ohne Hilfskontakte – 2 Neutralleiter voreilend 	20	5,5	3,7	250 × 160 × 120		H216-41800-734M1
	20	5,5	3,7	280 × 190 × 130		H216-41800-771M1
	25	7,5	5,5	250 × 160 × 120		H220-41800-734M1
	25	7,5	5,5	280 × 190 × 130		H220-41800-771M1
	32	11	7,5	250 × 160 × 120		H226-41800-734M1
	32	11	7,5	280 × 190 × 130		H226-41800-771M1
	40	15	11	250 × 160 × 120		H233-41800-734M1
	40	15	11	280 × 190 × 130		H233-41800-771M1
	40	15	11	280 × 190 × 130		B240-41800-771M1 *
	40	15	11	320 × 220 × 180		B240-41800-976M1
	50	18,5	15	280 × 190 × 130		B250-41800-771M1
	50	18,5	15	320 × 220 × 180		B250-41800-976M1
	63	22	18,5	280 × 190 × 130		B263-41800-771M1
	63	22	18,5	320 × 220 × 180		B263-41800-976M1
	63	22	18,5	440 × 320 × 180		H406-41800-578M1
80	30	22	440 × 320 × 180		H408-41800-578M1	
100	37	30	440 × 320 × 180		H410-41800-578M1	
125	45	37	440 × 320 × 180		H412-41800-578M1	

* größerer Anschlussquerschnitt, siehe Seite 154

¹ max. Anschlussquerschnitt 16 mm² an N- und/oder PE-Gehäuseklemme

Weitere Schaltprogramme ab Seite 132.

Abmessungen in mm:

Aufbau der Bestellnummer		
Typ	Schaltprogramm	Bauform
B250	41400	711M1
Best.-Nr.	B250-41400-711M1	

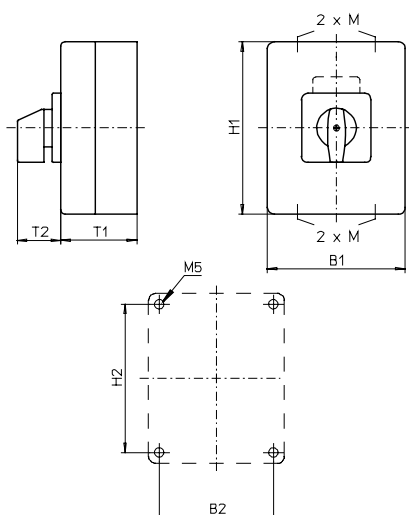
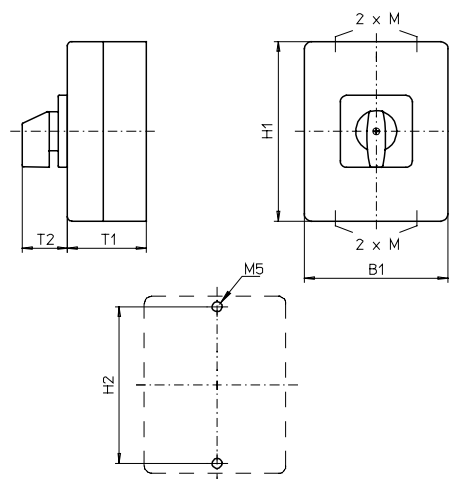
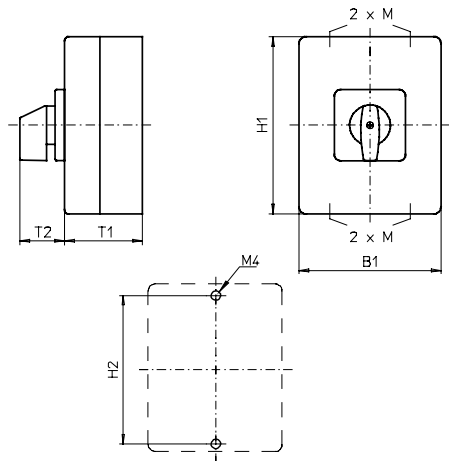

Isolierstoffgehäuse **125 × 100 × 85 mm**
und **175 × 115 × 100 mm**:

Typen H216 / H220 / H226 / H233 / B240 / B250 / B263:

Bauform	H1	B1	T1	T2	2×M	H2
701M1	125	100	85	32	20/25	115
711M1	175	115	100	39	20/25	165
721M1	175	115	100	39	20/25	165

Isolierstoffgehäuse **250 × 160 × 120 mm**:

Typen H216 / H220 / H226 / H233 / B240 / B250 / B263 /
H406 / H408 / H410 / H412:

Bauform	H1	B1	T1	T2	2×M	H2
731M1	250	160	120	39	32/40	235
734M1	250	160	120	39	32/40	235

Isolierstoffgehäuse **280 × 190 × 130 mm**:

Typen H216 / H220 / H226 / H233:

Bauform	H1	B1	T1	T2	2×M	H2	B2
771M1	280	190	130	39	40×1,5	254	164

Typen B240 / B250 / B263:

Bauform	H1	B1	T1	T2	2×M	H2	B2
771M1	280	190	130	39	40×1,5	254	164

Typen H406 / H408 / H410:

Bauform	H1	B1	T1	T2	2×M	H2	B2
771M1	280	190	130	52	40×1,5	254	164

Lasttrennschalter

Ein-/Ausschalter Gekapselte Schalter mit Isolierstoffgehäuse

Abmessungen in mm:

Aufbau der Bestellnummer		
Typ	Schaltprogramm	Bauform
H406	41600	578M1
Best.-Nr.	H406-41600-578M1	

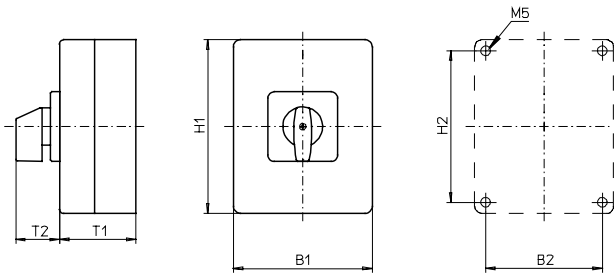

Isolierstoffgehäuse **320 × 220 × 180 mm:**

Typen B240 / B250 / B263:

Bauform	H1	B1	T1	T2	H2	B2
976M1	320	220	180	52	293	193

Flanschplatten ohne Vorprägungen

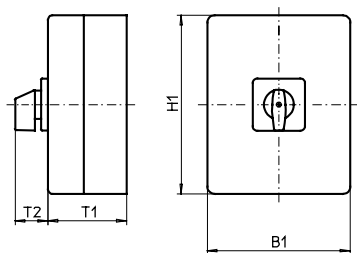

Isolierstoffgehäuse **440 × 320 × 180 mm:**

Typen H406 / H408 / H410 / H412:

Bauform	H1	B1	T1	T2	H2	B2
578M1	440	320	180	52	480	293

Flanschplatten ohne Vorprägungen

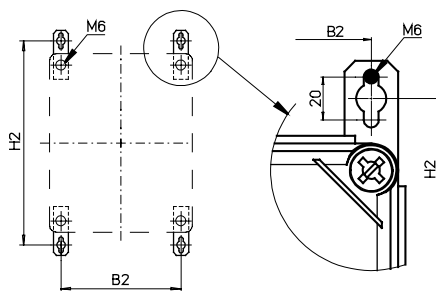



Zugehörige Befestigungslaschen sind im Lieferumfang enthalten.

Ein-/Ausschalter

- Gekapselte Schalter mit Isolierstoffgehäuse (Polycarbonat)
- EMV-Anwendung, Verbindungssystem zur unterbrechungsfreien Durchführung abgeschirmter Kabel bestehend aus Schirmblech und 4 Schirmklammern $\varnothing 12-16$ mm
- Deckelverriegelung in EIN-Stellung
- 3- bis 6-polig
- 20 A bis 63 A
- IP66

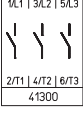
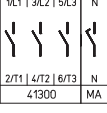
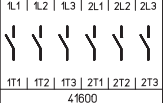

Schaltprogramm	Bemessungsdaten (IEC 60947) Betriebsstrom I_e Betriebsleistung (bei 380-440 V)			Gehäuse- abmessungen (H x B x T) (mm)	M-Griff silber/schwarz	IP66
	AC-21A (A)	AC-23A (kW)	AC-3 (kW)		 	
41300 – 3-polig – ohne Hilfskontakte 	20	5,5	3,7	175 x 115 x 100	H216-41300-716M1	
	25	7,5	5,5	175 x 115 x 100	H220-41300-716M1	
	32	11	7,5	175 x 115 x 100	H226-41300-716M1	
	40	15	11	175 x 115 x 100	H233-41300-716M1	
	40	15	11	175 x 115 x 100	B240-41300-716M1*	
	50	18,5	15	175 x 115 x 100	B250-41300-716M1	
	63	22	18,5	175 x 115 x 100	B263-41300-716M1	
41400 – 4-polig – ohne Hilfskontakte – Neutralleiter voreilend 	20	5,5	3,7	175 x 115 x 100	H216-41400-716M1	
	25	7,5	5,5	175 x 115 x 100	H220-41400-716M1	
	32	11	7,5	175 x 115 x 100	H226-41400-716M1	
	40	15	11	175 x 115 x 100	H233-41400-716M1	
	40	15	11	175 x 115 x 100	B240-41400-716M1*	
	50	18,5	15	175 x 115 x 100	B250-41400-716M1	
	63	22	18,5	175 x 115 x 100	B263-41400-716M1	
41600 – 6-polig – ohne Hilfskontakte 	20	5,5	3,7	175 x 115 x 100	H216-41600-726M1	
	25	7,5	5,5	175 x 115 x 100	H220-41600-726M1	
	32	11	7,5	175 x 115 x 100	H226-41600-726M1	
	40	15	11	175 x 115 x 100	H233-41600-726M1	

* größerer Anschlussquerschnitt, siehe Seite 154

Weitere Schaltprogramme ab Seite 132.

Abmessungen in mm:

Typen H216 / H220 / H226 / H233 / B240 / B250 / B263:

Bauform	H1	B1	T1	T2	2xM	H2
716M1	175	115	100	39	20/25	165
726M1	175	115	100	39	20/25	165

Lasttrennschalter

Ein-/Ausschalter Gekapselte Schalter mit Stahlgehäuse

Ein-/Ausschalter

- Gekapselte Schalter mit Stahlgehäuse (pulverbeschichtet)
- Deckelverriegelung in EIN-Stellung
- 3- bis 8-polig
- 20 A bis 125 A
- IP66

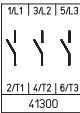

Schaltprogramm	Bemessungsdaten (IEC 60947) Betriebs- Betriebsleistung strom I _e (bei 380–440 V)			Gehäuse- abmessungen (H × B × T) (mm)	M-Griff silber/schwarz	IP66
	AC-21A (A)	AC-23A (kW)	AC-3 (kW)		Bestellnummer	
41300 – 3-polig – ohne Hilfskontakte 	20	5,5	3,7	150 × 150 × 120	H216-41300-086M1	
	20	5,5	3,7	200 × 150 × 120	H216-41300-186M1	
	25	7,5	5,5	150 × 150 × 120	H220-41300-086M1	
	25	7,5	5,5	200 × 150 × 120	H220-41300-186M1	
	32	11	7,5	150 × 150 × 120	H226-41300-086M1	
	32	11	7,5	200 × 150 × 120	H226-41300-186M1	
	40	15	11	200 × 150 × 120	H233-41300-186M1	
	40	15	11	200 × 150 × 120	B240-41300-086M1*	
	50	18,5	15	200 × 150 × 120	B250-41300-086M1	
	63	22	18,5	200 × 150 × 120	B263-41300-086M1	
	63	22	18,5	200 × 150 × 120	H406-41300-986M1*	
	63	22	18,5	300 × 250 × 150	H406-41300-186M1	
	63	22	18,5	400 × 300 × 155	H406-41300-181M1¹	
	80	30	22	200 × 150 × 120	H408-41300-986M1	
	80	30	22	300 × 250 × 150	H408-41300-186M1	
	80	30	22	400 × 300 × 155	H408-41300-181M1¹	
100	37	30	300 × 250 × 150	H410-41300-186M1		
100	37	30	400 × 300 × 155	H410-41300-181M1¹		
125	45	37	300 × 250 × 150	H412-41300-186M1		
125	45	37	400 × 300 × 155	H412-41300-181M1¹		

* größerer Anschlussquerschnitt, siehe Seite 154

¹ mit Tür

Weitere Schaltprogramme ab Seite 132.

Lasttrennschalter

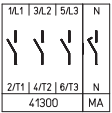
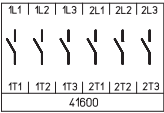
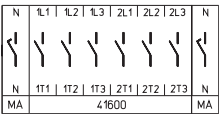

Ein-/Ausschalter Gekapselte Schalter mit Stahlgehäuse

Schaltprogramm	Bemessungsdaten (IEC 60947) Betriebs- Betriebsleistung strom I _e (bei 380–440 V)			Befestigungsmaß (mm)	M-Griff silber/schwarz	IP66
	AC-21A (A)	AC-23A (kW)	AC-3 (kW)			
41400 – 4-polig – ohne Hilfskontakte – Neutralleiter voreilend 	20	5,5	3,7	150 × 150 × 120	H216-41400-086M1	
	20	5,5	3,7	200 × 150 × 120	H216-41400-186M1	
	25	7,5	5,5	150 × 150 × 120	H220-41400-086M1	
	25	7,5	5,5	200 × 150 × 120	H220-41400-186M1	
	32	11	7,5	150 × 150 × 120	H226-41400-086M1	
	32	11	7,5	200 × 150 × 120	H226-41400-186M1	
	40	15	11	200 × 150 × 120	H233-41400-186M1	
	40	15	11	200 × 150 × 120	B240-41400-086M1*	
	50	18,5	15	200 × 150 × 120	B250-41400-086M1	
	63	22	18,5	200 × 150 × 120	B263-41400-086M1	
	63	22	18,5	200 × 150 × 120	H406-41400-986M1*	
	63	22	18,5	300 × 250 × 150	H406-41400-186M1	
	63	22	18,5	400 × 300 × 155	H406-41400-181M1¹	
	80	30	22	200 × 150 × 120	H408-41400-986M1	
	80	30	22	300 × 250 × 150	H408-41400-186M1	
	80	30	22	400 × 300 × 155	H408-41400-181M1¹	
	100	37	30	300 × 250 × 150	H410-41400-186M1	
	100	37	30	400 × 300 × 155	H410-41400-181M1¹	
125	45	37	300 × 250 × 150	H412-41400-186M1		
125	45	37	400 × 300 × 155	H412-41400-181M1¹		
41600 – 6-polig – ohne Hilfskontakte 	20	5,5	3,7	200 × 150 × 120	H216-41600-186M1	
	25	7,5	5,5	200 × 150 × 120	H220-41600-186M1	
	32	11	7,5	200 × 150 × 120	H226-41600-186M1	
	40	15	11	200 × 150 × 120	H233-41600-186M1	
	40	15	11	300 × 250 × 150	B240-41600-186M1	
	50	18,5	15	300 × 250 × 150	B250-41600-186M1	
	63	22	18,5	300 × 250 × 150	B263-41600-186M1	
	63	22	18,5	300 × 250 × 150	H406-41600-186M1*	
	63	22	18,5	400 × 300 × 155	H406-41600-181M1¹	
	80	30	22	300 × 250 × 150	H408-41600-186M1	
	80	30	22	400 × 300 × 155	H408-41600-181M1¹	
	100	37	30	300 × 250 × 150	H410-41600-186M1	
	100	37	30	400 × 300 × 155	H410-41600-181M1¹	
125	45	37	300 × 250 × 150	H412-41600-186M1		
125	45	37	400 × 300 × 155	H412-41600-181M1¹		
41800 – 8-polig – ohne Hilfskontakte – 2 Neutralleiter voreilend 	20	5,5	3,7	200 × 150 × 120	H216-41800-186M1	
	25	7,5	5,5	200 × 150 × 120	H220-41800-186M1	
	32	11	7,5	200 × 150 × 120	H226-41800-186M1	
	40	15	11	200 × 150 × 120	H233-41800-186M1	
	40	15	11	300 × 250 × 150	B240-41800-186M1	
	50	18,5	15	300 × 250 × 150	B250-41800-186M1	
	63	22	18,5	300 × 250 × 150	B263-41800-186M1	
	63	22	18,5	300 × 250 × 150	H406-41800-186M1*	
	63	22	18,5	400 × 300 × 155	H406-41800-181M1¹	
	80	30	22	300 × 250 × 150	H408-41800-186M1	
	80	30	22	400 × 300 × 155	H408-41800-181M1¹	
	100	37	30	300 × 250 × 150	H410-41800-186M1	
	100	37	30	400 × 300 × 155	H410-41800-181M1¹	
	125	45	37	300 × 250 × 150	H412-41800-186M1	
	125	45	37	400 × 300 × 155	H412-41800-181M1¹	

* größerer Anschlussquerschnitt, siehe Seite 154

¹ mit Tür

Weitere Schaltprogramme ab Seite 132.

Lasttrennschalter

Ein-/Ausschalter Gekapselte Schalter mit Stahlgehäuse

Abmessungen in mm:

Aufbau der Bestellnummer

Typ	Schaltprogramm	Bauform
H406	41400	186M1
Best.-Nr.	H406-41400-186M1	

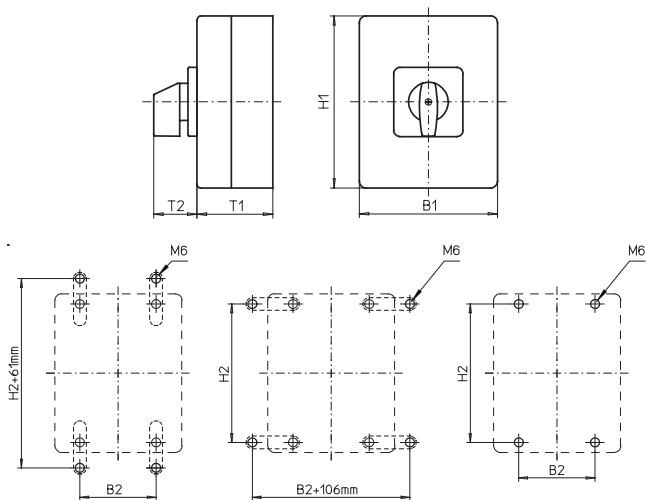

Zugehörige Befestigungslaschen bitte getrennt bestellen, siehe Seite 148.

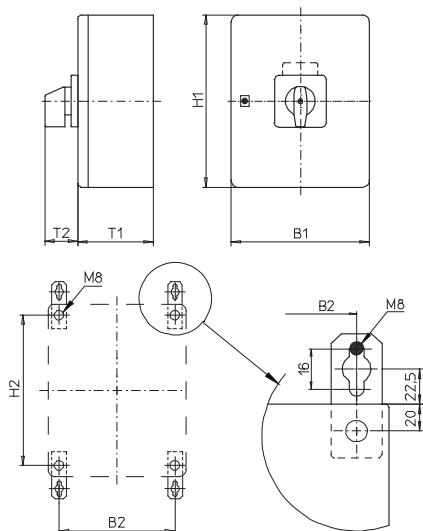

Zugehörige Befestigungslaschen bitte getrennt bestellen, siehe Seite 148.

Stahlgehäuse **150 × 150 × 120 mm / 200 × 150 × 120 mm / 300 × 250 × 150 mm:**

Typen H216 / H220 / H226 / H233:

Bauform	H1	B1	T1	T2	H2	B2
086M1	150	150	120	39	132	85
186M1	200	150	120	39	182	85

Typen B240 / B250 / B263:

Bauform	H1	B1	T1	T2	H2	B2
086M1	200	150	120	39	182	85
186M1	300	250	150	52	282	185

Typen H406 / H408 / H410 / H412:

Bauform	H1	B1	T1	T2	H2	B2
186M1	300	250	150	52	282	185
986M1	200	150	120	52	182	85

Stahlgehäuse **400 × 300 × 155 mm:**

Typen H406 / H408 / H410 / H412:



Bauform	H1	B1	T1	T2	H2	B2
181M1	400	300	155	52	360	260

Flanschplatte unten

Ein-/Ausschalter

- Gekapselte Schalter mit Edelstahlgehäuse (gebürstet)
- Deckelverriegelung in EIN-Stellung
- 3- bis 8-polig
- 20 A bis 125 A
- IP66

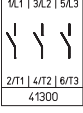
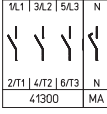

Schaltprogramm	Bemessungsdaten (IEC 60947) Betriebs- Betriebsleistung strom I _e (bei 380–440 V)			Gehäuse- abmessungen (H × B × T) (mm)	M-Griff silber/schwarz	IP66
	AC-21A (A)	AC-23A (kW)	AC-3 (kW)		 	
41300 – 3-polig – ohne Hilfskontakte 	20	5,5	3,7	150 × 150 × 120	H216-41300-096M1	
	20	5,5	3,7	200 × 150 × 120	H216-41300-196M1	
	25	7,5	5,5	150 × 150 × 120	H220-41300-096M1	
	25	7,5	5,5	200 × 150 × 120	H220-41300-196M1	
	32	11	7,5	150 × 150 × 120	H226-41300-096M1	
	32	11	7,5	200 × 150 × 120	H226-41300-196M1	
	40	15	11	200 × 150 × 120	H233-41300-196M1	
	40	15	11	200 × 150 × 120	B240-41300-096M1*	
	50	18,5	15	200 × 150 × 120	B250-41300-096M1	
	63	22	18,5	200 × 150 × 120	B263-41300-096M1	
	63	22	18,5	200 × 150 × 120	H406-41300-996M1*	
	63	22	18,5	300 × 250 × 150	H406-41300-196M1	
	80	30	22	200 × 150 × 120	H408-41300-996M1	
	80	30	22	300 × 250 × 150	H408-41300-196M1	
100	37	30	300 × 250 × 150	H410-41300-196M1		
125	45	37	300 × 250 × 150	H412-41300-196M1		
41400 – 4-polig – ohne Hilfskontakte – Neutralleiter voreilend 	20	5,5	3,7	150 × 150 × 120	H216-41400-096M1	
	20	5,5	3,7	200 × 150 × 120	H216-41400-196M1	
	25	7,5	5,5	150 × 150 × 120	H220-41400-096M1	
	25	7,5	5,5	200 × 150 × 120	H220-41400-196M1	
	32	11	7,5	150 × 150 × 120	H226-41400-096M1	
	32	11	7,5	200 × 150 × 120	H226-41400-196M1	
	40	15	11	200 × 150 × 120	H233-41400-196M1	
	40	15	11	200 × 150 × 120	B240-41400-096M1*	
	50	18,5	15	200 × 150 × 120	B250-41400-096M1	
	63	22	18,5	200 × 150 × 120	B263-41400-096M1	
	63	22	18,5	200 × 150 × 120	H406-41400-996M1*	
	63	22	18,5	300 × 250 × 150	H406-41400-196M1	
	80	30	22	200 × 150 × 120	H408-41400-996M1	
	80	30	22	300 × 250 × 150	H408-41400-196M1	
100	37	30	300 × 250 × 150	H410-41400-196M1		
125	45	37	300 × 250 × 150	H412-41400-196M1		

* größerer Anschlussquerschnitt, siehe Seite 154

Weitere Schaltprogramme ab Seite 132.

Lasttrennschalter

Ein-/Ausschalter Gekapselte Schalter mit Edelstahlgehäuse

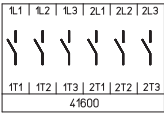
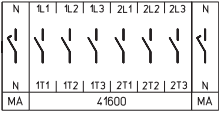
Schaltprogramm	Bemessungsdaten (IEC 60947) Betriebsstrom I_e Betriebsleistung (bei 380–440 V)			Gehäuse- abmessungen (H × B × T) (mm)	M-Griff silber/schwarz	IP66
	AC-21A (A)	AC-23A (kW)	AC-3 (kW)		Bestellnummer	
41600 – 6-polig – ohne Hilfskontakte 	20	5,5	3,7	200 × 150 × 120	H216-41600-196M1	
	25	7,5	5,5	200 × 150 × 120	H220-41600-196M1	
	32	11	7,5	200 × 150 × 120	H226-41600-196M1	
	40	15	11	200 × 150 × 120	H233-41600-196M1	
	40	15	11	300 × 250 × 150	B240-41600-196M1	
	50	18,5	15	300 × 250 × 150	B250-41600-196M1	
	63	22	18,5	300 × 250 × 150	B263-41600-196M1	
	63	22	18,5	300 × 250 × 150	H406-41600-196M1*	
	80	30	22	300 × 250 × 150	H408-41600-196M1	
	100	37	30	300 × 250 × 150	H410-41600-196M1	
125	45	37	300 × 250 × 150	H412-41600-196M1		
41800 – 8-polig – ohne Hilfskontakte – 2 Neutralleiter voreilend 	20	5,5	3,7	200 × 150 × 120	H216-41800-196M1	
	25	7,5	5,5	200 × 150 × 120	H220-41800-196M1	
	32	11	7,5	200 × 150 × 120	H226-41800-196M1	
	40	15	11	200 × 150 × 120	H233-41800-196M1	
	40	15	11	300 × 250 × 150	B240-41800-196M1	
	50	18,5	15	300 × 250 × 150	B250-41800-196M1	
	63	22	18,5	300 × 250 × 150	B263-41800-196M1	
	63	22	18,5	300 × 250 × 150	H406-41800-196M1*	
	80	30	22	300 × 250 × 150	H408-41800-196M1	
	100	37	30	300 × 250 × 150	H410-41800-196M1	
125	45	37	300 × 250 × 150	H412-41800-196M1		

* größerer Anschlussquerschnitt, siehe Seite 154

Weitere Schaltprogramme ab Seite 132.

Abmessungen in mm:

Aufbau der Bestellnummer		
Typ	Schaltprogramm	Bauform
B240	41800	196M1
Best.-Nr.	B240-41800-196M1	

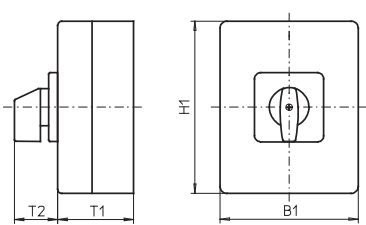
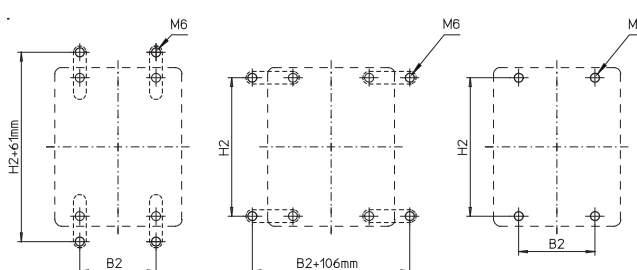
Typen H216 / H220 / H226 / H233:

Bauform	H1	B1	T1	T2	H2	B2
096M1	150	150	120	39	132	85
196M1	200	150	120	39	182	85

Typen B240 / B250 / B263:

Bauform	H1	B1	T1	T2	H2	B2
096M1	200	150	120	39	182	85
196M1	300	250	150	52	282	185

Typen H406 / H408 / H410 / H412:

Bauform	H1	B1	T1	T2	H2	B2
196M1	300	250	150	52	282	185
996M1	200	150	120	52	182	85

Zugehörige Befestigungslaschen bitte getrennt bestellen, siehe Seite 148.

Umschalter

- Fronteinbauschalter mit Vierlochbefestigung
- 3- bis 4-polig
- 20 A bis 315 A
- IP66 / IP55







Schaltprogramm	Bemessungsdaten (IEC 60947) Betriebs- Betriebsleistung strom I _e (bei 380–440 V)			Befestigungsmaß (mm)	M-Griff silber/schwarz	Griffverriegelung V-Griff silber/schwarz	Griffverriegelung V-Griff silber/schwarz
	AC-21A (A)	AC-23A (kW)	AC-3 (kW)			Nullstellung verriegelbar	alle Stellungen verriegelbar
					IP66	IP66	IP66
					Bestellnummer	Bestellnummer	Bestellnummer
71300 – 3-polig – ohne Hilfskontakte 	20	5,5	3,7	48 × 48	H216-71300-013M1	H216-71300-013V1	H216-71300-014V1
	25	7,5	5,5	48 × 48	H220-71300-013M1	H220-71300-013V1	H220-71300-014V1
	32	11	7,5	48 × 48	H226-71300-013M1	H226-71300-013V1	H226-71300-014V1
	40	15	11	48 × 48	H233-71300-013M1	H233-71300-013V1	H233-71300-014V1
	40	15	11	48 × 48	B240-71300-013M1*	B240-71300-013V1*	B240-71300-014V1*
	50	18,5	15	48 × 48	B250-71300-013M1	B250-71300-013V1	B250-71300-014V1
	63	22	18,5	48 × 48	B263-71300-013M1	B263-71300-013V1	B263-71300-014V1
	63	22	18,5	48 × 48	H406-71300-003M1*	H406-71300-003V1*	H406-71300-004V1*
	63	22	18,5	68 × 68	H406-71300-013M1	–	–
	80	30	22	48 × 48	H408-71300-003M1	H408-71300-003V1	H408-71300-004V1
	80	30	22	68 × 68	H408-71300-013M1	–	–
	100	37	30	48 × 48	H410-71300-003M1	H410-71300-003V1	H410-71300-004V1
	100	37	30	68 × 68	H410-71300-013M1	–	–
	125	45	37	48 × 48	H412-71300-003M1	H412-71300-003V1	H412-71300-004V1
125	45	37	68 × 68	H412-71300-013M1	–	–	

Bemessungsdaten (IEC 60947) Betriebs- Betriebsleistung strom I _e (bei 380–440 V)			Befestigungsmaß (mm)	G-Griff silber/schwarz	Vorhängeschlossperre H-Griff silber/schwarz	Vorhängeschlossperre H-Griff silber/schwarz
AC-21A (A)	AC-23A (kW)	AC-3 (kW)			Nullstellung verriegelbar	alle Stellungen verriegelbar
				IP55	IP55	IP55
				Bestellnummer	Bestellnummer	Bestellnummer
160	75	45	68 × 68	K616-71300-003G1	K616-71300-003H1	K616-71300-004H1
160	75	45	104 × 104	K616-71300-013G1	K616-71300-013H1	K616-71300-014H1
315	132	55	104 × 104	K830-71300-003G1	K830-71300-003H1	K830-71300-004H1

* größerer Anschlussquerschnitt, siehe Seite 154
 Weitere Schaltprogramme ab Seite 132.

Lasttrennschalter

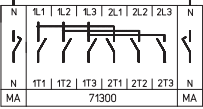
Umschalter Fronteinbau Vierlochbefestigung

Schaltprogramm	Bemessungsdaten (IEC 60947) Betriebsstrom I_e Betriebsleistung (bei 380–440 V)			Befestigungsmaß (mm)	M-Griff silber/schwarz  IP66	Griffverriegelung V-Griff silber/schwarz  Nullstellung verriegelbar IP66	Griffverriegelung V-Griff silber/schwarz  alle Stellungen verriegelbar IP66
	AC-21A (A)	AC-23A (kW)	AC-3 (kW)		Bestellnummer	Bestellnummer	Bestellnummer
71500 – 4-polig – ohne Hilfskontakte – Neutralleiter voreilend – mit Verbindungsbrücke neutral 	20	5,5	3,7	48 × 48	H216-71500-013M1	H216-71500-013V1	H216-71500-014V1
	25	7,5	5,5	48 × 48	H220-71500-013M1	H220-71500-013V1	H220-71500-014V1
	32	11	7,5	48 × 48	H226-71500-013M1	H226-71500-013V1	H226-71500-014V1
	40	15	11	48 × 48	H233-71500-013M1	H233-71500-013V1	H233-71500-014V1
	40	15	11	48 × 48	B240-71500-013M1*	B240-71500-013V1*	B240-71500-014V1*
	50	18,5	15	48 × 48	B250-71500-013M1	B250-71500-013V1	B250-71500-014V1
	63	22	18,5	48 × 48	B263-71500-013M1	B263-71500-013V1	B263-71500-014V1
	63	22	18,5	48 × 48	H406-71500-003M1*	H406-71500-003V1*	H406-71500-004V1*
	63	22	18,5	68 × 68	H406-71500-013M1	–	–
	80	30	22	48 × 48	H408-71500-003M1	H408-71500-003V1	H408-71500-004V1
	80	30	22	68 × 68	H408-71500-013M1	–	–
	100	37	30	48 × 48	H410-71500-003M1	H410-71500-003V1	H410-71500-004V1
	100	37	30	68 × 68	H410-71500-013M1	–	–
	125	45	37	48 × 48	H412-71500-003M1	H412-71500-003V1	H412-71500-004V1
	125	45	37	68 × 68	H412-71500-013M1	–	–
		Bemessungsdaten (IEC 60947) Betriebsstrom I_e Betriebsleistung (bei 380–440 V)			Befestigungsmaß (mm)	G-Griff silber/schwarz  IP55	Vorhängeschlossperre H-Griff silber/schwarz  Nullstellung verriegelbar IP55
AC-21A (A)	AC-23A (kW)	AC-3 (kW)	Bestellnummer	Bestellnummer		Bestellnummer	
160	75	45	68 × 68	K616-71500-003G1	K616-71500-003H1	K616-71500-004H1	
160	75	45	104 × 104	K616-71500-013G1	K616-71500-013H1	K616-71500-014H1	
315	132	55	104 × 104	K830-71500-003G1	K830-71500-003H1	K830-71500-004H1	

* größerer Anschlussquerschnitt, siehe Seite 154

Weitere Schaltprogramme ab Seite 132.

Abmessungen in mm:

Aufbau der Bestellnummer

Typ	Schaltprogramm	Bauform
H412	71300	013M1
Best.-Nr.	H412-71300-013M1	

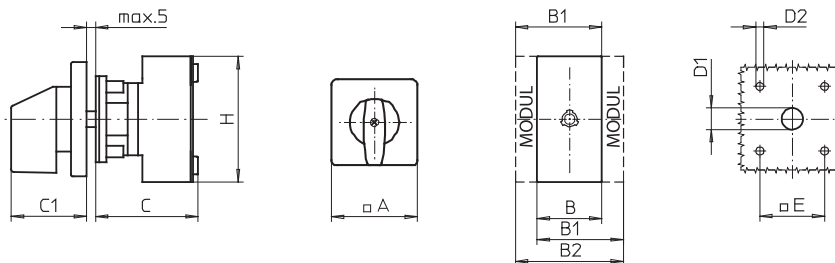

Typen H216 / H220 / H226 / H233:

Bauform	A	B	B1	B2	C	C1	D1	D2	E	H
013M1	64	72	84	96	66	39	15	5	48	70
013V1	64	72	84	96	66	39	15	5	48	70
014V1	64	72	84	96	66	39	15	5	48	70

Typen H406 / H408 / H410 / H412:

Bauform	A	B	B1	B2	C	C1	D1	D2	E	H
003M1	64	140	159	178	86	39	15	5	48	80
003V1	64	140	159	178	86	39	15	5	48	80
004V1	64	140	159	178	86	39	15	5	48	80
013M1	88	140	159	178	86	52	15	5,5	68	80

Typen B240 / B250 / B263:

Bauform	A	B	B1	B2	C	C1	D1	D2	E	H
013M1	64	100	119	138	70	39	15	5	48	72
013V1	64	100	119	138	70	39	15	5	48	72
014V1	64	100	119	138	70	39	15	5	48	72

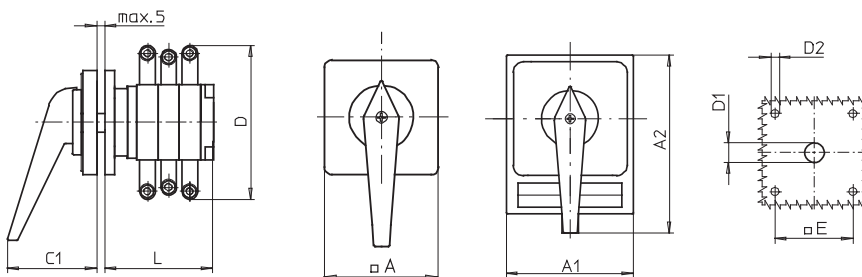

Typ K616:

Bauform	Schaltprogramm	A	A1	A2	C1	D*	D1	D2	E	L
003G1	71300	88	-	-	66	150	20	5,5	68	136
003G1	71500	88	-	-	66	150	20	5,5	68	168
003H1	71300	-	98	142	83	150	20	5,5	68	136
003H1	71500	-	98	142	83	150	20	5,5	68	168
004H1	71300	-	98	142	83	150	20	5,5	68	136
004H1	71500	-	98	142	83	150	20	5,5	68	168
013G1	71300	130	-	-	74	150	20	5,5	104	136
013G1	71500	130	-	-	74	150	20	5,5	104	168
013H1	71300	-	130	176	93	150	20	5,5	104	136
013H1	71500	-	130	176	93	150	20	5,5	104	168
014H1	71300	-	130	176	93	150	20	5,5	104	136
014H1	71500	-	130	176	93	150	20	5,5	104	168

Typ K830:

Bauform	Schaltprogramm	A	A1	A2	C1	D*	D1	D2	E	L
003G1	71300	130	-	-	74	210	20	5,5	104	161
003G1	71500	130	-	-	74	210	20	5,5	104	197
003H1	71300	-	130	178	93	210	20	5,5	104	161
003H1	71500	-	130	178	93	210	20	5,5	104	197
004H1	71300	-	130	178	93	210	20	5,5	104	161
004H1	71500	-	130	178	93	210	20	5,5	104	197

Weitere Schaltprogramme und zugehörige Abmessungen für Typen K auf Anfrage.

* einschließlich Anschlusswinkel

Lasttrennschalter

Umschalter Fronteinbau Zentralbefestigung

Umschalter

- Fronteinbauschalter mit Zentralbefestigung
- 3- bis 4-polig
- 20 A bis 40 A
- IP66



Schaltprogramm	Bemessungsdaten (IEC 60947) Betriebs- Betriebsleistung strom I _e (bei 380–440 V)			Befestigungsmaß (mm)	M-Griff silber/schwarz	Griffverriegelung V-Griff silber/schwarz	Griffverriegelung V-Griff silber/schwarz
	AC-21A (A)	AC-23A (kW)	AC-3 (kW)				
71300 – 3-polig – ohne Hilfskontakte 	20	5,5	3,7	∅ 22,5			
	20	5,5	3,7	∅ 30,5			
	25	7,5	5,5	∅ 22,5			
	25	7,5	5,5	∅ 30,5			
	32	11	7,5	∅ 22,5			
	32	11	7,5	∅ 30,5			
	40	15	11	∅ 22,5			
	40	15	11	∅ 30,5			
71500 – 4-polig – ohne Hilfskontakte – Neutralleiter voreilend – mit Verbindungsbrücke neutral 	20	5,5	3,7	∅ 22,5			
	20	5,5	3,7	∅ 30,5			
	25	7,5	5,5	∅ 22,5			
	25	7,5	5,5	∅ 30,5			
	32	11	7,5	∅ 22,5			
	32	11	7,5	∅ 30,5			
	40	15	11	∅ 22,5			
	40	15	11	∅ 30,5			

Weitere Schaltprogramme ab Seite 132.

Abmessungen in mm:

Aufbau der Bestellnummer		
Typ	Schaltprogramm	Bauform
H216	71300	214M1
Best.-Nr.	H216-71300-214M1	

Typen H216 / H220 / H226 / H233:

Bauform	A	B	B1	B2	C	C1	D1	G1	G2	H
203V1	64	72	84	96	83	39	30,5	33	4,8	70
204M1	64	72	84	96	83	39	30,5	33	4,8	70
204V1	64	72	84	96	83	39	30,5	33	4,8	70
213V1	64	72	84	96	83	39	22,5	24,2	3,2	70
214M1	64	72	84	96	83	39	22,5	24,2	3,2	70
214V1	64	72	84	96	83	39	22,5	24,2	3,2	70

Umschalter

- Bodeneinbauschalter mit Schnappbefestigung
- für Installationsverteiler
- 3- bis 4-polig
- 20 A bis 125 A
- IP30



Schaltprogramm	Bemessungsdaten (IEC 60947) Betriebs- Betriebsleistung strom I _e (bei 380–440 V)			Frontschildmaß für Normausschnitt 45 mm (H × B) (mm)	M-Griff silber/schwarz	Griffverriegelung V-Griff silber/schwarz	Griffverriegelung V-Griff silber/schwarz
	AC-21A (A)	AC-23A (kW)	AC-3 (kW)			Nullstellung verriegelbar	alle Stellungen verriegelbar
					Bestellnummer	Bestellnummer	Bestellnummer
71300 – 3-polig – ohne Hilfskontakte 	20	5,5	3,7	45 × 76	H216-71300-026M1	H216-71300-028V1	H216-71300-027V1
	25	7,5	5,5	45 × 76	H220-71300-026M1	H220-71300-028V1	H220-71300-027V1
	32	11	7,5	45 × 76	H226-71300-026M1	H226-71300-028V1	H226-71300-027V1
	40	15	11	45 × 76	H233-71300-026M1	H233-71300-028V1	H233-71300-027V1
	40	15	11	45 × 105	B240-71300-026M1*	B240-71300-028V1*	B240-71300-027V1*
	50	18,5	15	45 × 105	B250-71300-026M1	B250-71300-028V1	B250-71300-027V1
	63	22	18,5	45 × 105	B263-71300-026M1	B263-71300-028V1	B263-71300-027V1
	63	22	18,5	45 × 72	H406-71300-126M1*	H406-71300-128V1*	H406-71300-127V1*
	80	30	22	45 × 72	H408-71300-126M1	H408-71300-128V1	H408-71300-127V1
	100	37	30	45 × 72	H410-71300-126M1	H410-71300-128V1	H410-71300-127V1
	125	45	37	45 × 72	H412-71300-126M1	H412-71300-128V1	H412-71300-127V1
	71500 – 4-polig – ohne Hilfskontakte – Neutralleiter voreilend – mit Verbindungsbrücke neutral 	20	5,5	3,7	45 × 76	H216-71500-026M1	H216-71500-028V1
25		7,5	5,5	45 × 76	H220-71500-026M1	H220-71500-028V1	H220-71500-027V1
32		11	7,5	45 × 76	H226-71500-026M1	H226-71500-028V1	H226-71500-027V1
40		15	11	45 × 76	H233-71500-026M1	H233-71500-028V1	H233-71500-027V1
40		15	11	45 × 105	B240-71500-026M1*	B240-71500-028V1*	B240-71500-027V1*
50		18,5	15	45 × 105	B250-71500-026M1	B250-71500-028V1	B250-71500-027V1
63		22	18,5	45 × 105	B263-71500-026M1	B263-71500-028V1	B263-71500-027V1
63		22	18,5	45 × 72	H406-71500-126M1*	H406-71500-128V1*	H406-71500-127V1*
80		30	22	45 × 72	H408-71500-126M1	H408-71500-128V1	H408-71500-127V1
100		37	30	45 × 72	H410-71500-126M1	H410-71500-128V1	H410-71500-127V1
125		45	37	45 × 72	H412-71500-126M1	H412-71500-128V1	H412-71500-127V1

* größerer Anschlussquerschnitt, siehe Seite 154

Weitere Schaltprogramme ab Seite 132.

Lasttrennschalter

Umschalter **Bodeneinbau** Schnappbefestigung für Installationsverteiler

Abmessungen in mm:

Aufbau der Bestellnummer

Typ	Schaltprogramm	Bauform
H406	71300	128V1
Best.-Nr.	H406-71300-128V1	

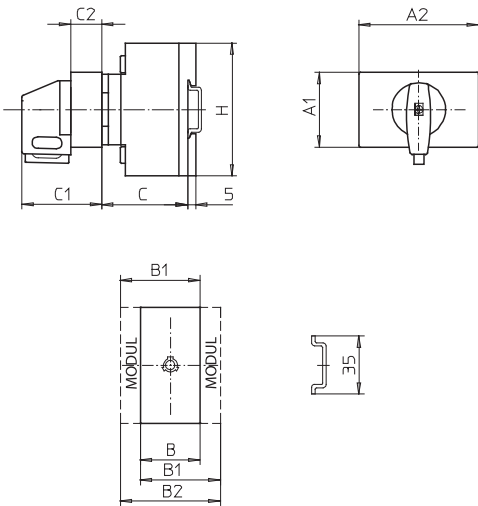

Typen H216 / H220 / H226 / H233:

Bauform	A1	A2	B	B1	B2	C	C1	C2	H
026M1	45	76	72	84	96	40	51,5	25,5	70
027V1	45	76	72	84	96	40	51,5	25,5	70
028V1	45	76	72	84	96	40	51,5	25,5	70

Typen B240 / B250 / B263:

Bauform	A1	A2	B	B1	B2	C	C1	C2	H
026M1	45	105	100	119	138	40	51,5	25,5	72
027V1	45	105	100	119	138	40	51,5	25,5	72
028V1	45	105	100	119	138	40	51,5	25,5	72

Typen H406 / H408 / H410 / H412:

Bauform	A1	A2	B	B1	B2	C	C1	C2	H
126M1	45	72	140	159	178	67	48	16	80
127V1	45	72	140	159	178	67	48	16	80
128V1	45	72	140	159	178	67	48	16	80

Umschalter

- Bodeneinbauschalter mit Schnappbefestigung
- Türverriegelung
- 3- bis 4-polig
- 20 A bis 125 A
- IP66
- mit Modular- bzw. Metallachsverlängerung
- Zentral- bzw. Vierlochbefestigung frontseitig



Bodeneinbauschalter mit Schnappbefestigung und Türverriegelung werden in zwei Verlängerungsvarianten angeboten:

- Schalter mit **Modularachsverlängerung** können durch das Aufstecken zusätzlicher Module auf das benötigte Einbaumaß C verlängert werden. Die zugehörigen Verlängerungsbauteile finden Sie auf Seite 145.

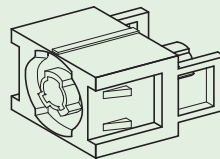
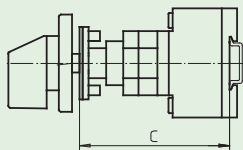

AVC2/AVC4
Modularachsverlängerung

- Bei Schaltern mit **Metallachsverlängerung** ist die benötigte Metallachse nicht im Lieferumfang enthalten und muss getrennt bestellt werden. Angaben zum Einbaumaß C und zu den erhältlichen Ausführungen finden Sie auf Seite 146.

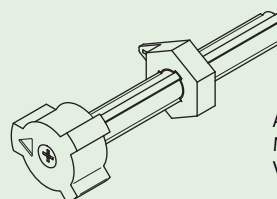
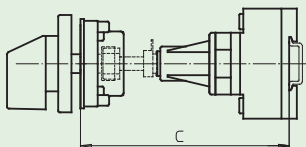

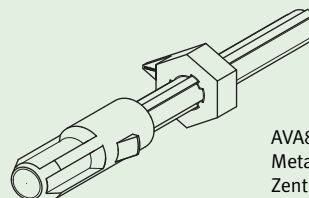
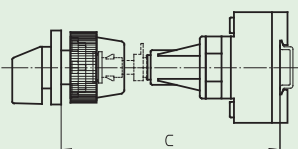

AVB8
Metallachsverlängerung für
Vierlochbefestigung (frontseitig)



AVA8
Metallachsverlängerung für
Zentralbefestigung (frontseitig)

Lasttrennschalter

Umschalter Bodeneinbau Schnappbefestigung mit Türverriegelung

Schaltprogramm	Bemessungsdaten (IEC 60947) Betriebsstrom I_e Betriebsleistung (bei 380–440 V)			Befestigungsmaß (frontseitig) (mm)	M-Griff silber/schwarz  IP66	Griffverriegelung V-Griff silber/schwarz  Nullstellung verriegelbar IP66	Griffverriegelung V-Griff silber/schwarz  alle Stellungen verriegelbar IP66
	AC-21A (A)	AC-23A (kW)	AC-3 (kW)		Bestellnummer	Bestellnummer	Bestellnummer

71300
– 3-polig
– ohne Hilfskontakte

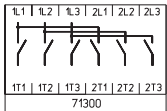

mit Modularachsverlängerung:

→ Verlängerungsbauteile siehe Seite 145!

20	5,5	3,7	48 x 48	H216-71300-248M1	H216-71300-248V1	H216-71300-249V1
25	7,5	5,5	48 x 48	H220-71300-248M1	H220-71300-248V1	H220-71300-249V1
32	11	7,5	48 x 48	H226-71300-248M1	H226-71300-248V1	H226-71300-249V1
40	15	11	48 x 48	H233-71300-248M1	H233-71300-248V1	H233-71300-249V1
40	15	11	48 x 48	B240-71300-248M1*	B240-71300-248V1*	B240-71300-249V1*
50	18,5	15	48 x 48	B250-71300-248M1	B250-71300-248V1	B250-71300-249V1
63	22	18,5	48 x 48	B263-71300-248M1	B263-71300-248V1	B263-71300-249V1
63	22	18,5	48 x 48	H406-71300-242M1*	H406-71300-242V1*	H406-71300-243V1*
80	30	22	48 x 48	H408-71300-242M1	H408-71300-242V1	H408-71300-243V1
100	37	30	48 x 48	H410-71300-242M1	H410-71300-242V1	H410-71300-243V1
125	45	37	48 x 48	H412-71300-242M1	H412-71300-242V1	H412-71300-243V1

mit Metallachsverlängerung:

→ Zugehörige Metallachse getrennt bestellen, siehe Seite 146!

20	5,5	3,7	48 x 48	H216-71300-482M1	H216-71300-482V1	H216-71300-449V1
20	5,5	3,7	∅ 22,5	H216-71300-285M1	H216-71300-285V1	H216-71300-291V1
25	7,5	5,5	48 x 48	H220-71300-482M1	H220-71300-482V1	H220-71300-449V1
25	7,5	5,5	∅ 22,5	H220-71300-285M1	H220-71300-285V1	H220-71300-291V1
32	11	7,5	48 x 48	H226-71300-482M1	H226-71300-482V1	H226-71300-449V1
32	11	7,5	∅ 22,5	H226-71300-285M1	H226-71300-285V1	H226-71300-291V1
40	15	11	48 x 48	H233-71300-482M1	H233-71300-482V1	H233-71300-449V1
40	15	11	48 x 48	B240-71300-482M1*	B240-71300-482V1*	B240-71300-449V1*
40	15	11	∅ 22,5	H233-71300-285M1	H233-71300-285V1	H233-71300-291V1
40	15	11	∅ 22,5	B240-71300-285M1*	B240-71300-285V1*	B240-71300-291V1*
50	18,5	15	48 x 48	B250-71300-482M1	B250-71300-482V1	B250-71300-449V1
50	18,5	15	∅ 22,5	B250-71300-285M1	B250-71300-285V1	B250-71300-291V1
63	22	18,5	48 x 48	B263-71300-482M1	B263-71300-482V1	B263-71300-449V1
63	22	18,5	48 x 48	H406-71300-481M1*	H406-71300-481V1*	H406-71300-485V1*
63	22	18,5	∅ 22,5	B263-71300-285M1	B263-71300-285V1	B263-71300-291V1
63	22	18,5	∅ 22,5	H406-71300-283M1*	H406-71300-283V1*	H406-71300-293V1*
80	30	22	48 x 48	H408-71300-481M1	H408-71300-481V1	H408-71300-485V1
80	30	22	∅ 22,5	H408-71300-283M1	H408-71300-283V1	H408-71300-293V1
100	37	30	48 x 48	H410-71300-481M1	H410-71300-481V1	H410-71300-485V1
100	37	30	∅ 22,5	H410-71300-283M1	H410-71300-283V1	H410-71300-293V1
125	45	37	48 x 48	H412-71300-481M1	H412-71300-481V1	H412-71300-485V1
125	45	37	∅ 22,5	H412-71300-283M1	H412-71300-283V1	H412-71300-293V1

* größerer Anschlussquerschnitt, siehe Seite 154

Weitere Schaltprogramme ab Seite 132.

Schaltprogramm	Bemessungsdaten (IEC 60947) Betriebsstrom I_e Betriebsleistung (bei 380–440 V)			Befestigungsmaß (frontseitig) (mm)	M-Griff silber/schwarz	Griffverriegelung V-Griff silber/schwarz	Griffverriegelung V-Griff silber/schwarz
	AC-21A (A)	AC-23A (kW)	AC-3 (kW)		IP66	Nullstellung verriegelbar IP66	alle Stellungen verriegelbar IP66
					Bestellnummer	Bestellnummer	Bestellnummer

71500

- 4-polig
- ohne Hilfskontakte
- Neutralleiter voreilend
- mit Verbindungsbrücke neutral

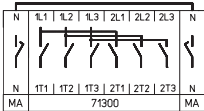

mit Modularachsverlängerung:

→ Verlängerungsbauteile siehe Seite 145!

20	5,5	3,7	48 x 48	H216-71500-248M1	H216-71500-248V1	H216-71500-249V1
25	7,5	5,5	48 x 48	H220-71500-248M1	H220-71500-248V1	H220-71500-249V1
32	11	7,5	48 x 48	H226-71500-248M1	H226-71500-248V1	H226-71500-249V1
40	15	11	48 x 48	H233-71500-248M1	H233-71500-248V1	H233-71500-249V1
40	15	11	48 x 48	B240-71500-248M1*	B240-71500-248V1*	B240-71500-249V1*
50	18,5	15	48 x 48	B250-71500-248M1	B250-71500-248V1	B250-71500-249V1
63	22	18,5	48 x 48	B263-71500-248M1	B263-71500-248V1	B263-71500-249V1
63	22	18,5	48 x 48	H406-71500-242M1*	H406-71500-242V1*	H406-71500-243V1*
80	30	22	48 x 48	H408-71500-242M1	H408-71500-242V1	H408-71500-243V1
100	37	30	48 x 48	H410-71500-242M1	H410-71500-242V1	H410-71500-243V1
125	45	37	48 x 48	H412-71500-242M1	H412-71500-242V1	H412-71500-243V1

mit Metallachsverlängerung:

→ Zugehörige Metallachse getrennt bestellen, siehe Seite 146!

20	5,5	3,7	48 x 48	H216-71500-482M1	H216-71500-482V1	H216-71500-449V1
20	5,5	3,7	∅ 22,5	H216-71500-285M1	H216-71500-285V1	H216-71500-291V1
25	7,5	5,5	48 x 48	H220-71500-482M1	H220-71500-482V1	H220-71500-449V1
25	7,5	5,5	∅ 22,5	H220-71500-285M1	H220-71500-285V1	H220-71500-291V1
32	11	7,5	48 x 48	H226-71500-482M1	H226-71500-482V1	H226-71500-449V1
32	11	7,5	∅ 22,5	H226-71500-285M1	H226-71500-285V1	H226-71500-291V1
40	15	11	48 x 48	H233-71500-482M1	H233-71500-482V1	H233-71500-449V1
40	15	11	48 x 48	B240-71500-482M1*	B240-71500-482V1*	B240-71500-449V1*
40	15	11	∅ 22,5	H233-71500-285M1	H233-71500-285V1	H233-71500-291V1
40	15	11	∅ 22,5	B240-71500-285M1*	B240-71500-285V1*	B240-71500-291V1*
50	18,5	15	48 x 48	B250-71500-482M1	B250-71500-482V1	B250-71500-449V1
50	18,5	15	∅ 22,5	B250-71500-285M1	B250-71500-285V1	B250-71500-291V1
63	22	18,5	48 x 48	B263-71500-482M1	B263-71500-482V1	B263-71500-449V1
63	22	18,5	48 x 48	H406-71500-481M1*	H406-71500-481V1*	H406-71500-485V1*
63	22	18,5	∅ 22,5	B263-71500-285M1	B263-71500-285V1	B263-71500-291V1
63	22	18,5	∅ 22,5	H406-71500-283M1*	H406-71500-283V1*	H406-71500-293V1*
80	30	22	48 x 48	H408-71500-481M1	H408-71500-481V1	H408-71500-485V1
80	30	22	∅ 22,5	H408-71500-283M1	H408-71500-283V1	H408-71500-293V1
100	37	30	48 x 48	H410-71500-481M1	H410-71500-481V1	H410-71500-485V1
100	37	30	∅ 22,5	H410-71500-283M1	H410-71500-283V1	H410-71500-293V1
125	45	37	48 x 48	H412-71500-481M1	H412-71500-481V1	H412-71500-485V1
125	45	37	∅ 22,5	H412-71500-283M1	H412-71500-283V1	H412-71500-293V1

* größerer Anschlussquerschnitt, siehe Seite 154

Weitere Schaltprogramme ab Seite 132.

Lasttrennschalter

Umschalter Bodeneinbau Schnappbefestigung mit Türverriegelung

Abmessungen in mm:

Aufbau der Bestellnummer		
Typ	Schaltprogramm	Bauform
H233	71500	482V1
Best.-Nr.	H233-71500-482V1	

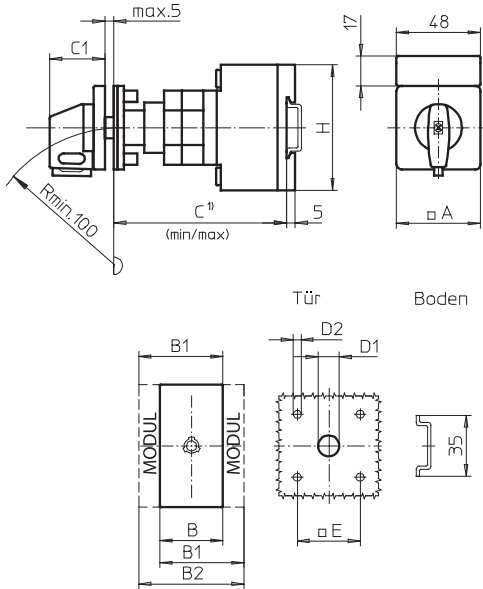

¹⁾ Einbaumaß: Innenseite Tür bis Oberkante Tragschiene, Abmessungen mit Verlängerung siehe Seite 145.

Türverriegelung mit **Modularachsverlängerung**: Vierlochbefestigung (frontseitig)

Typen H216 / H220 / H226 / H233:

Bauform	A	B	B1	B2	C _{min}	C _{max}	C1	D1	D2	E	H
248M1	64	72	84	96	100	115	39	15	5	48	70
248V1	64	72	84	96	100	115	39	15	5	48	70
249V1	64	72	84	96	100	115	39	15	5	48	70

Typen B240 / B250 / B263:

Bauform	A	B	B1	B2	C _{min}	C _{max}	C1	D1	D2	E	H
248M1	64	100	119	138	104	119	39	15	5	48	72
248V1	64	100	119	138	104	119	39	15	5	48	72
249V1	64	100	119	138	104	119	39	15	5	48	72

Typen H406 / H408 / H410 / H412:

Bauform	A	B	B1	B2	C _{min}	C _{max}	C1	D1	D2	E	H
242M1	64	140	159	178	115	130	40	15	5	48	80
242V1	64	140	159	178	115	130	40	15	5	48	80
243V1	64	140	159	178	115	130	40	15	5	48	80

Türverriegelung mit **Metallachsverlängerung**: Vierlochbefestigung (frontseitig)

Typen H216 / H220 / H226 / H233:

Bauform	A	B	B1	B2	C1	D1	D2	E	H
449V1	64	72	84	96	39	15	5	48	70
482M1	64	72	84	96	39	15	5	48	70
482V1	64	72	84	96	39	15	5	48	70

Typen B240 / B250 / B263:

Bauform	A	B	B1	B2	C1	D1	D2	E	H
449V1	64	100	119	138	39	15	5	48	72
482M1	64	100	119	138	39	15	5	48	72
482V1	64	100	119	138	39	15	5	48	72

Typen H406 / H408 / H410 / H412:

Bauform	A	B	B1	B2	C1	D1	D2	E	H
481M1	64	140	159	178	40	15	5	48	80
481V1	64	140	159	178	40	15	5	48	80
485V1	64	140	159	178	40	15	5	48	80

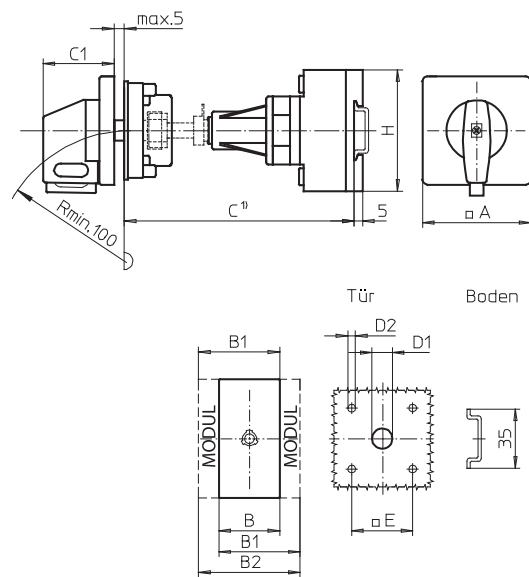

¹⁾ Einbaumaß: Innenseite Tür bis Oberkante Tragschiene, Abmessungen siehe Seite 146.

Abmessungen in mm:

Aufbau der Bestellnummer		
Typ	Schaltprogramm	Bauform
B240	71500	285V1
Best.-Nr.	B240-71500-285V1	

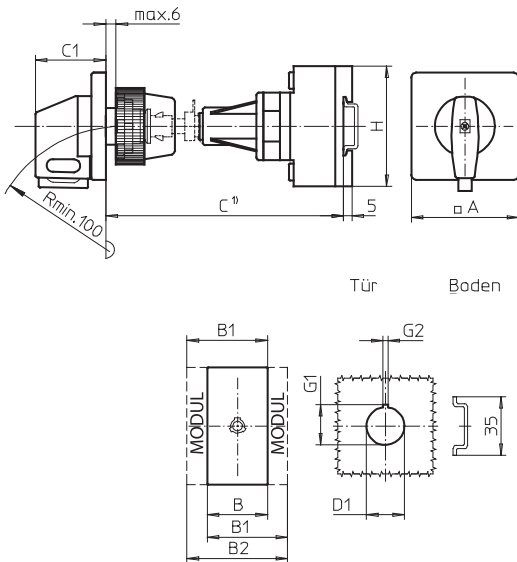

¹⁾ Einbaumaß: Außenseite Tür bis Oberkante Tragschiene, Abmessungen siehe Seite 146.

Türverriegelung mit **Metallachsverlängerung:**
Zentralbefestigung (frontseitig)

Typen H216 / H220 / H226 / H233:

Bauform	A	B	B1	B2	C1	D1	G1	G2	H
285M1	64	72	84	96	39	22,5	24,2	3,2	70
285V1	64	72	84	96	39	22,5	24,2	3,2	70
291V1	64	72	84	96	39	22,5	24,2	3,2	70

Typen B240 / B250 / B263:

Bauform	A	B	B1	B2	C1	D1	G1	G2	H
285M1	64	100	119	138	39	22,5	24,2	3,2	72
285V1	64	100	119	138	39	22,5	24,2	3,2	72
291V1	64	100	119	138	39	22,5	24,2	3,2	72

Typen H406 / H408 / H410 / H412:

Bauform	A	B	B1	B2	C1	D1	G1	G2	H
283V1	64	140	159	178	39	22,5	24,2	3,2	80
293V1	64	140	159	178	39	22,5	24,2	3,2	80
283M1	64	140	159	178	39	22,5	24,2	3,2	80







Lasttrennschalter

Umschalter Bodeneinbau Vierlochbefestigung mit Türverriegelung

Umschalter

- Bodeneinbauschalter mit Vierlochbefestigung und Türverriegelung
- 3- bis 4-polig
- 160 A bis 315 A
- IP55



Schaltprogramm	Bemessungsdaten (IEC 60947) Betriebs- Betriebsleistung strom I _e (bei 380–440 V)			Befestigungsmaß (boden-/frontseitig) (mm)	G-Griff silber/schwarz	Vorhängeschlosssperre H-Griff silber/schwarz	Vorhängeschlosssperre H-Griff silber/schwarz
	AC-21A (A)	AC-23A (kW)	AC-3 (kW)		  IP55	  Nullstellung verriegelbar IP55	  alle Stellungen verriegelbar IP55
					Bestellnummer	Bestellnummer	Bestellnummer
71300 – 3-polig – ohne Hilfskontakte	160	75	45	68 × 68 / 68 × 68	K616-71300-042G1	K616-71300-042H1	K616-71300-043H1
	315	132	55	104 × 104 / 104 × 104	K830-71300-042G1	K830-71300-042H1	K830-71300-043H1

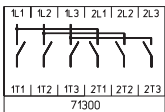

71500 – 4-polig – ohne Hilfskontakte – Neutralleiter voreilend – mit Verbindungsbrücke neutral	160	75	45	68 × 68 / 68 × 68	K616-71500-042G1	K616-71500-042H1	K616-71500-043H1
	315	132	55	104 × 104 / 104 × 104	K830-71500-042G1	K830-71500-042H1	K830-71500-043H1

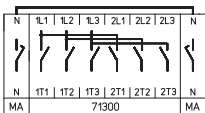

Abmessungen in mm:

Aufbau der Bestellnummer		
Typ	Schaltprogramm	Bauform
K830	71300	042G1
Best.-Nr.	K830-71300-042G1	

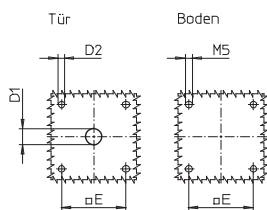
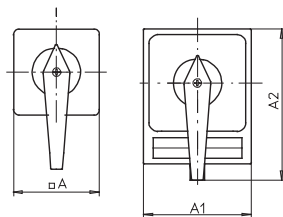
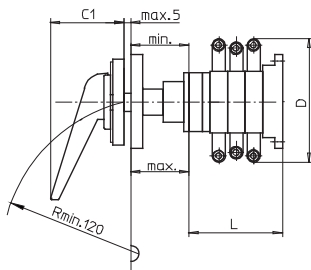

Typ K616:

Bauform	Schaltprogramm	A	A1	A2	C1	D*	D1	D2	E	min	max	L
042G1	71300	88	-	-	66	150	15	5,5	68	48	60	136
042G1	71500	88	-	-	66	150	15	5,5	68	48	60	168
042H1	71300	-	98	142	83	150	15	5,5	68	48	60	136
042H1	71500	-	98	142	83	150	15	5,5	68	48	60	168
043H1	71300	-	98	142	83	150	15	5,5	68	48	60	136
043H1	71500	-	98	142	83	150	15	5,5	68	48	60	168

Typ K830:

Bauform	Schaltprogramm	A	A1	A2	C1	D*	D1	D2	E	min	max	L
042G1	71300	130	-	-	74	210	20	5,5	104	75	102	161
042G1	71500	130	-	-	74	210	20	5,5	104	75	102	197
042H1	71300	-	130	176	93	210	20	5,5	104	75	102	161
042H1	71500	-	130	176	93	210	20	5,5	104	75	102	197
043H1	71300	-	130	176	93	210	20	5,5	104	75	102	161
043H1	71500	-	130	176	93	210	20	5,5	104	75	102	197

* einschließlich Anschlusswinkel

Weitere Schaltprogramme und zugehörige Abmessungen für Typen K auf Anfrage.







Lasttrennschalter

Umschalter Gekapselte Schalter mit Isolierstoffgehäuse

Umschalter

- Gekapselte Schalter mit Isolierstoffgehäuse (Polycarbonat)
- Deckelverriegelung in Stellung 1 und 2
- 3- bis 4-polig
- 20 A bis 315 A
- IP66



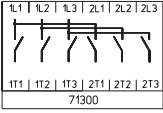





Schaltprogramm	Bemessungsdaten (IEC 60947) Betriebs- Betriebsleistung strom I _e (bei 380–440 V)			Gehäuse- abmessungen (H × B × T) (mm)	M-Griff silber/schwarz	Griffverriegelung V-Griff silber/schwarz	Griffverriegelung V-Griff silber/schwarz
	AC-21A (A)	AC-23A (kW)	AC-3 (kW)		  IP66	  Nullstellung verriegelbar IP66	  alle Stellungen verriegelbar IP66
					Bestellnummer	Bestellnummer	Bestellnummer
71300 – 3-polig – ohne Hilfskontakte 	20	5,5	3,7	250 × 160 × 120	H216-71300-732M1	H216-71300-732V1	H216-71300-728V1
	20	5,5	3,7	280 × 190 × 130	H216-71300-772M1	H216-71300-772V1	H216-71300-773V1
	25	7,5	5,5	250 × 160 × 120	H220-71300-732M1	H220-71300-732V1	H220-71300-728V1
	25	7,5	5,5	280 × 190 × 130	H220-71300-772M1	H220-71300-772V1	H220-71300-773V1
	32	11	7,5	250 × 160 × 120	H226-71300-732M1	H226-71300-732V1	H226-71300-728V1
	32	11	7,5	280 × 190 × 130	H226-71300-772M1	H226-71300-772V1	H226-71300-773V1
	40	15	11	250 × 160 × 120	H233-71300-732M1	H233-71300-732V1	H233-71300-728V1
	40	15	11	280 × 190 × 130	H233-71300-772M1	H233-71300-772V1	H233-71300-773V1
	40	15	11	280 × 190 × 130	B240-71300-772M1*¹	B240-71300-772V1*¹	B240-71300-773V1*¹
	40	15	11	320 × 220 × 180	B240-71300-978M1	–	–
	50	18,5	15	280 × 190 × 130	B250-71300-772M1¹	B250-71300-772V1¹	B250-71300-773V1¹
	50	18,5	15	320 × 220 × 180	B250-71300-978M1	–	–
	63	22	18,5	280 × 190 × 130	B263-71300-772M1¹	B263-71300-772V1¹	B263-71300-773V1¹
	63	22	18,5	320 × 220 × 180	B263-71300-978M1	–	–
	63	22	18,5	320 × 220 × 180	H406-71300-976M1*	–	–
	63	22	18,5	440 × 320 × 180	H406-71300-576M1	–	–
80	30	22	320 × 220 × 180	H408-71300-976M1	–	–	
80	30	22	440 × 320 × 180	H408-71300-576M1	–	–	
100	37	30	320 × 220 × 180	H410-71300-976M1	–	–	
100	37	30	440 × 320 × 180	H410-71300-576M1	–	–	
125	45	37	320 × 220 × 180	H412-71300-976M1	–	–	
125	45	37	440 × 320 × 180	H412-71300-576M1	–	–	

* größerer Anschlussquerschnitt, siehe Seite 154

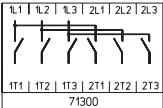
¹ max. Anschlussquerschnitt 16 mm² an N- und/oder PE-Gehäuseklemme

Weitere Schaltprogramme ab Seite 132.

Schaltprogramm	Bemessungsdaten (IEC 60947) Betriebsstrom I_e Betriebsleistung (bei 380–440 V)			Gehäuse- abmessungen (H × B × T) (mm)	Vorhängeschlossperre H-Griff silber/schwarz  Nullstellung verriegelbar IP66	Vorhängeschlossperre H-Griff silber/schwarz  alle Stellungen verriegelbar IP66
	AC-21A (A)	AC-23A (kW)	AC-3 (kW)		Bestellnummer	Bestellnummer
71300 – 3-polig – ohne Hilfskontakte 	40	15	11	320 × 220 × 180	B240-71300-976H1	B240-71300-979H1
	50	18,5	15	320 × 220 × 180	B250-71300-976H1	B250-71300-979H1
	63	22	18,5	320 × 220 × 180	B263-71300-976H1	B263-71300-979H1
	63	22	18,5	320 × 220 × 180	H406-71300-976H1*	H406-71300-979H1*
	63	22	18,5	440 × 320 × 180	H406-71300-576H1	H406-71300-579H1
	80	30	22	320 × 220 × 180	H408-71300-976H1	H408-71300-979H1
	80	30	22	440 × 320 × 180	H408-71300-576H1	H408-71300-579H1
	100	37	30	320 × 220 × 180	H410-71300-976H1	H410-71300-979H1
	100	37	30	440 × 320 × 180	H410-71300-576H1	H410-71300-579H1
	125	45	37	320 × 220 × 180	H412-71300-976H1	H412-71300-979H1
	125	45	37	440 × 320 × 180	H412-71300-576H1	H412-71300-579H1
	160	75	45	440 × 320 × 255	K616-71300-176H1	–
	315	132	55	640 × 320 × 330	K830-71300-176H1	–

Schaltprogramm	Bemessungsdaten (IEC 60947) Betriebsstrom I_e Betriebsleistung (bei 380–440 V)			Gehäuse- abmessungen (H × B × T) (mm)	M-Griff silber/schwarz  IP66	Griffverriegelung V-Griff silber/schwarz  Nullstellung verriegelbar IP66	Griffverriegelung V-Griff silber/schwarz  alle Stellungen verriegelbar IP66
	AC-21A (A)	AC-23A (kW)	AC-3 (kW)		Bestellnummer	Bestellnummer	Bestellnummer
71500 – 4-polig – ohne Hilfskontakte – Neutralleiter voreilend – mit Verbindungsbrücke neutral 	20	5,5	3,7	250 × 160 × 120	H216-71500-732M1	H216-71500-732V1	H216-71500-728V1
	20	5,5	3,7	280 × 190 × 130	H216-71500-772M1	H216-71500-772V1	H216-71500-773V1
	25	7,5	5,5	250 × 160 × 120	H220-71500-732M1	H220-71500-732V1	H220-71500-728V1
	25	7,5	5,5	280 × 190 × 130	H220-71500-772M1	H220-71500-772V1	H220-71500-773V1
	32	11	7,5	250 × 160 × 120	H226-71500-732M1	H226-71500-732V1	H226-71500-728V1
	32	11	7,5	280 × 190 × 130	H226-71500-772M1	H226-71500-772V1	H226-71500-773V1
	40	15	11	250 × 160 × 120	H233-71500-732M1	H233-71500-732V1	H233-71500-728V1
	40	15	11	280 × 190 × 130	H233-71500-772M1	H233-71500-772V1	H233-71500-773V1
	40	15	11	280 × 190 × 130	B240-71500-772M1*¹	B240-71500-772V1*¹	B240-71500-773V1*¹
	40	15	11	320 × 220 × 180	B240-71500-978M1	–	–
	50	18,5	15	280 × 190 × 130	B250-71500-772M1¹	B250-71500-772V1¹	B250-71500-773V1¹
	50	18,5	15	320 × 220 × 180	B250-71500-978M1	–	–
	63	22	18,5	280 × 190 × 130	B263-71500-772M1¹	B263-71500-772V1¹	B263-71500-773V1¹
	63	22	18,5	320 × 220 × 180	B263-71500-978M1	–	–
	63	22	18,5	320 × 220 × 180	H406-71500-976M1*	–	–
	63	22	18,5	440 × 320 × 180	H406-71500-576M1	–	–
	80	30	22	320 × 220 × 180	H408-71500-976M1	–	–
	80	30	22	440 × 320 × 180	H408-71500-576M1	–	–
	100	37	30	320 × 220 × 180	H410-71500-976M1	–	–
	100	37	30	440 × 320 × 180	H410-71500-576M1	–	–
	125	45	37	320 × 220 × 180	H412-71500-976M1	–	–
	125	45	37	440 × 320 × 180	H412-71500-576M1	–	–



* größerer Anschlussquerschnitt, siehe Seite 154

¹ max. Anschlussquerschnitt 16 mm² an N- und/oder PE-Gehäuseklemme

Weitere Schaltprogramme ab Seite 132.

Lasttrennschalter

Umschalter Gekapselte Schalter mit Isolierstoffgehäuse

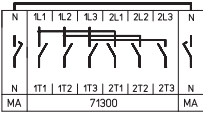
Schaltprogramm	Bemessungsdaten (IEC 60947) Betriebsstrom I_e Betriebsleistung (bei 380–440 V)			Gehäuse- abmessungen (H × B × T) (mm)	Vorhängeschlossperre H-Griff silber/schwarz  Nullstellung verriegelbar IP66	Vorhängeschlossperre H-Griff silber/schwarz  alle Stellungen verriegelbar IP66
	AC-21A (A)	AC-23A (kW)	AC-3 (kW)		Bestellnummer	Bestellnummer
71500 – 4-polig – ohne Hilfskontakte – Neutralleiter voreilend – mit Verbindungsbrücke neutral 	40	15	11	320 × 220 × 180	B240-71500-976H1	B240-71500-979H1
	50	18,5	15	320 × 220 × 180	B250-71500-976H1	B250-71500-979H1
	63	22	18,5	320 × 220 × 180	B263-71500-976H1	B263-71500-979H1
	63	22	18,5	320 × 220 × 180	H406-71500-976H1*	H406-71500-979H1*
	63	22	18,5	440 × 320 × 180	H406-71500-576H1	H406-71500-579H1
	80	30	22	320 × 220 × 180	H408-71500-976H1	H408-71500-979H1
	80	30	22	440 × 320 × 180	H408-71500-576H1	H408-71500-579H1
	100	37	30	320 × 220 × 180	H410-71500-976H1	H410-71500-979H1
	100	37	30	440 × 320 × 180	H410-71500-576H1	H410-71500-579H1
	125	45	37	320 × 220 × 180	H412-71500-976H1	H412-71500-979H1
	125	45	37	440 × 320 × 180	H412-71500-576H1	H412-71500-579H1
	160	75	45	440 × 320 × 255	K616-71500-176H1	–
	315	132	55	640 × 320 × 330	K830-71500-176H1	–

* größerer Anschlussquerschnitt, siehe Seite 154

Weitere Schaltprogramme ab Seite 132.

Abmessungen in mm:

Aufbau der Bestellnummer		
Typ	Schaltprogramm	Bauform
H216	71300	732M1
Best.-Nr.	H216-71300-732M1	

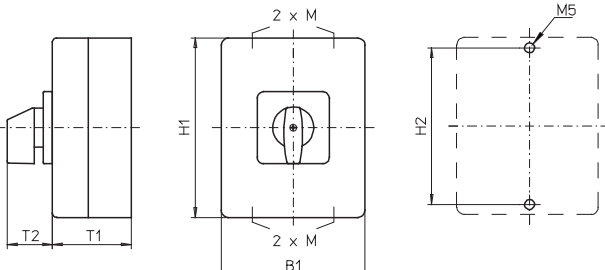

Isolierstoffgehäuse **250 × 160 × 120 mm:**

Typen H216 / H220 / H226 / H233:

Bauform	H1	B1	T1	T2	2×M	H2
728V1	250	160	120	39	32/40	235
732M1	250	160	120	39	32/40	235
732V1	250	160	120	39	32/40	235

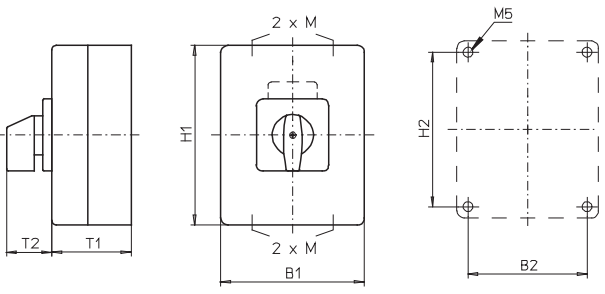

Isolierstoffgehäuse **280 × 190 × 130 mm**
und **320 × 220 × 180 mm:**

Typen H216 / H220 / H226 / H233 / B240 / B250 / B263 /
H406 / H408 / H410 / H412:

Bauform	H1	B1	T1	T2	2×M	H2	B2
772M1	280	190	130	39	40×1,5	254	164
772V1	280	190	130	39	40×1,5	254	164
773V1	280	190	130	39	40×1,5	254	164
976M1	320	220	180	52	– ¹	293	193
976H1	320	220	180	83	– ¹	293	193
978M1	320	220	180	52	– ¹	293	193
979H1	320	220	180	83	– ¹	293	193

¹ Flanschplatten ohne Vorprägungen

124

www.saelzer.com

Abmessungen in mm:

Aufbau der Bestellnummer		
Typ	Schaltprogramm	Bauform
K830	71500	176H1
Best.-Nr.	K830-71500-176H1	

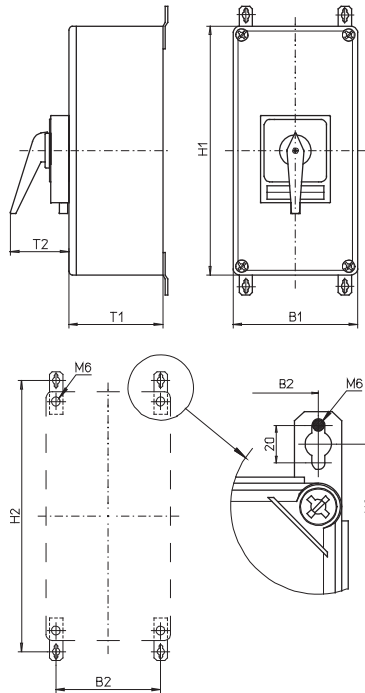

Zugehörige Befestigungslaschen sind im Lieferumfang enthalten.

Isolierstoffgehäuse **440 × 320 × 180 mm / 440 × 320 × 255 mm / 640 × 320 × 330 mm:**

Typen H406 / H408 / H410 / H412:

Bauform	H1	B1	T1	T2	H2	B2
576H1	440	320	180	83	480	293
576M1	440	320	180	52	480	293
579H1	440	320	180	83	480	293

Typ K616:

Bauform	H1	B1	T1	T2	H2	B2
176H1	440	320	255	83	480	293

Typ K830:

Bauform	H1	B1	T1	T2	H2	B2
176H1	640	320	330	93	680	293

Weitere Schaltprogramme und zugehörige Abmessungen für Typen K auf Anfrage.

Flanschplatten ohne Vorprägungen

Lasttrennschalter

Umschalter Gekapselte Schalter mit Isolierstoffgehäuse für EMV-Anwendung

Umschalter

- Gekapselte Schalter mit Isolierstoffgehäuse (Polycarbonat)
- EMV-Anwendung, Verbindungssystem zur unterbrechungsfreien Durchführung abgeschirmter Kabel bestehend aus Schirmblech und 4 Schirmklammern $\varnothing 12-16$ mm
- Deckelverriegelung in Stellung 1 und 2
- 3-polig
- 20 A bis 40 A
- IP66

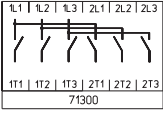

Schaltprogramm	Bemessungsdaten (IEC 60947) Betriebsstrom I_e Betriebsleistung (bei 380–440 V)			Gehäuse- abmessungen (H × B × T) (mm)	M-Griff silber/schwarz
	AC-21A (A)	AC-23A (kW)	AC-3 (kW)		 IP66 Bestellnummer
71300 – 3-polig – ohne Hilfskontakte 	20	5,5	3,7	175 × 115 × 100	H216-71300-727M1
	25	7,5	5,5	175 × 115 × 100	H220-71300-727M1
	32	11	7,5	175 × 115 × 100	H226-71300-727M1
	40	15	11	175 × 115 × 100	H233-71300-727M1

Weitere Schaltprogramme ab Seite 132.

Abmessungen in mm:

Aufbau der Bestellnummer		
Typ	Schaltprogramm	Bauform
H216	71300	727M1
Best.-Nr.	H216-71300-727M1	

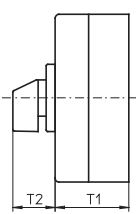
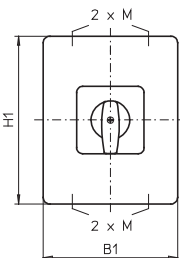
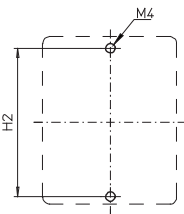





Typen H216 / H220 / H226 / H233:





Bauform	H1	B1	T1	T2	2×M	H2
727M1	175	115	100	39	20/25	165

Umschalter

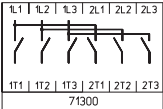
- Gekapselte Schalter mit Stahlgehäuse (pulverbeschichtet)
- Deckelverriegelung in Stellung 1 und 2
- 3- bis 4-polig
- 20 A bis 315 A
- IP66



Schaltprogramm	Bemessungsdaten (IEC 60947) Betriebsstrom I_e Betriebsleistung (bei 380–440 V)			Gehäuse- abmessungen (H × B × T) (mm)	M-Griff silber/schwarz	Griffverriegelung V-Griff silber/schwarz	Griffverriegelung V-Griff silber/schwarz
	AC-21A (A)	AC-23A (kW)	AC-3 (kW)		  IP66	  Nullstellung verriegelbar IP66	  alle Stellungen verriegelbar IP66
					Bestellnummer	Bestellnummer	Bestellnummer
71300 – 3-polig – ohne Hilfskontakte 	20	5,5	3,7	200 × 150 × 120	H216-71300-188M1	H216-71300-186V1	H216-71300-188V1
	25	7,5	5,5	200 × 150 × 120	H220-71300-188M1	H220-71300-186V1	H220-71300-188V1
	32	11	7,5	200 × 150 × 120	H226-71300-188M1	H226-71300-186V1	H226-71300-188V1
	40	15	11	200 × 150 × 120	H233-71300-188M1	H233-71300-186V1	H233-71300-188V1
	40	15	11	300 × 250 × 150	B240-71300-188M1	B240-71300-186V1	B240-71300-188V1
	50	18,5	15	300 × 250 × 150	B250-71300-188M1	B250-71300-186V1	B250-71300-188V1
	63	22	18,5	300 × 250 × 150	B263-71300-188M1	B263-71300-186V1	B263-71300-188V1
	63	22	18,5	300 × 250 × 150	H406-71300-186M1*	–	–
	63	22	18,5	400 × 300 × 155	H406-71300-181M1¹	–	–
	80	30	22	300 × 250 × 150	H408-71300-186M1	–	–
	80	30	22	400 × 300 × 155	H408-71300-181M1¹	–	–
	100	37	30	300 × 250 × 150	H410-71300-186M1	–	–
	100	37	30	400 × 300 × 155	H410-71300-181M1¹	–	–
	125	45	37	300 × 250 × 150	H412-71300-186M1	–	–
125	45	37	400 × 300 × 155	H412-71300-181M1¹	–	–	

Bemessungsdaten (IEC 60947) Betriebsstrom I_e Betriebsleistung (bei 380–440 V)			Gehäuse- abmessungen (H × B × T) (mm)	Vorhängeschlossperre H-Griff silber/schwarz	Vorhängeschlossperre H-Griff silber/schwarz
AC-21A (A)	AC-23A (kW)	AC-3 (kW)		  Nullstellung verriegelbar IP66	  alle Stellungen verriegelbar IP66
				Bestellnummer	Bestellnummer
63	22	18,5	300 × 250 × 150	H406-71300-186H1	H406-71300-189H1
63	22	18,5	400 × 300 × 155	H406-71300-183H1¹	–
80	30	22	300 × 250 × 150	H408-71300-186H1	H408-71300-189H1
80	30	22	400 × 300 × 155	H408-71300-183H1¹	–
100	37	30	300 × 250 × 150	H410-71300-186H1	H410-71300-189H1
100	37	30	400 × 300 × 155	H410-71300-183H1¹	–
125	45	37	300 × 250 × 150	H412-71300-186H1	H412-71300-189H1
125	45	37	400 × 300 × 155	H412-71300-183H1¹	–
160	75	45	500 × 400 × 300	K616-71300-186H1¹	–
315	132	55	600 × 400 × 300	K830-71300-186H1¹	–
315	132	55	800 × 400 × 300	K830-71300-286H1¹	–







* größerer Anschlussquerschnitt, siehe Seite 154

¹ mit Tür





Weitere Schaltprogramme ab Seite 132.

Lasttrennschalter

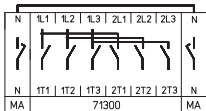
Umschalter Gekapselte Schalter mit Stahlgehäuse

Schaltprogramm	Bemessungsdaten (IEC 60947) Betriebs- Betriebsleistung strom I_e (bei 380–440 V)			Gehäuse- abmessungen (H × B × T) (mm)	M-Griff silber/schwarz	Griffverriegelung V-Griff silber/schwarz	Griffverriegelung V-Griff silber/schwarz
	AC-21A (A)	AC-23A (kW)	AC-3 (kW)		 	  Nullstellung verriegelbar	  alle Stellungen verriegelbar
					IP66	IP66	IP66
					Bestellnummer	Bestellnummer	Bestellnummer
71500 – 4-polig – ohne Hilfskontakte – Neutralleiter voreilend – mit Verbindungsbrücke neutral	20	5,5	3,7	200 × 150 × 120	H216-71500-188M1	H216-71500-186V1	H216-71500-188V1
	25	7,5	5,5	200 × 150 × 120	H220-71500-188M1	H220-71500-186V1	H220-71500-188V1
	32	11	7,5	200 × 150 × 120	H226-71500-188M1	H226-71500-186V1	H226-71500-188V1
	40	15	11	200 × 150 × 120	H233-71500-188M1	H233-71500-186V1	H233-71500-188V1
	40	15	11	300 × 250 × 150	B240-71500-188M1	B240-71500-186V1	B240-71500-188V1
	50	18,5	15	300 × 250 × 150	B250-71500-188M1	B250-71500-186V1	B250-71500-188V1
	63	22	18,5	300 × 250 × 150	B263-71500-188M1	B263-71500-186V1	B263-71500-188V1
	63	22	18,5	300 × 250 × 150	H406-71500-186M1*	–	–
	63	22	18,5	400 × 300 × 155	H406-71500-181M1¹	–	–
	80	30	22	300 × 250 × 150	H408-71500-186M1	–	–
	80	30	22	400 × 300 × 155	H408-71500-181M1¹	–	–
	100	37	30	300 × 250 × 150	H410-71500-186M1	–	–
	100	37	30	400 × 300 × 155	H410-71500-181M1¹	–	–
	125	45	37	300 × 250 × 150	H412-71500-186M1	–	–
125	45	37	400 × 300 × 155	H412-71500-181M1¹	–	–	



Bemessungsdaten (IEC 60947) Betriebs- Betriebsleistung strom I_e (bei 380–440 V)			Gehäuse- abmessungen (H × B × T) (mm)	Vorhängeschlossperre H-Griff silber/schwarz	Vorhängeschlossperre H-Griff silber/schwarz	
AC-21A (A)	AC-23A (kW)	AC-3 (kW)		  Nullstellung verriegelbar	  alle Stellungen verriegelbar	
				IP66	IP66	
				Bestellnummer	Bestellnummer	
63	22	18,5	300 × 250 × 150	H406-71500-186H1	H406-71500-189H1	
63	22	18,5	400 × 300 × 155	H406-71500-183H1¹	–	
80	30	22	300 × 250 × 150	H408-71500-186H1	H408-71500-189H1	
80	30	22	400 × 300 × 155	H408-71500-183H1¹	–	
100	37	30	300 × 250 × 150	H410-71500-186H1	H410-71500-189H1	
100	37	30	400 × 300 × 155	H410-71500-183H1¹	–	
125	45	37	300 × 250 × 150	H412-71500-186H1	H412-71500-189H1	
125	45	37	400 × 300 × 155	H412-71500-183H1¹	–	
160	75	45	500 × 400 × 300	K616-71500-186H1¹	–	
315	132	55	600 × 400 × 300	K830-71500-186H1¹	–	
315	132	55	800 × 400 × 300	K830-71500-286H1¹	–	

* größerer Anschlussquerschnitt, siehe Seite 154

¹ mit Tür

Weitere Schaltprogramme ab Seite 132.

Abmessungen in mm:

Aufbau der Bestellnummer		
Typ	Schaltprogramm	Bauform
H226	71500	186V1
Best.-Nr.	H226-71500-186V1	

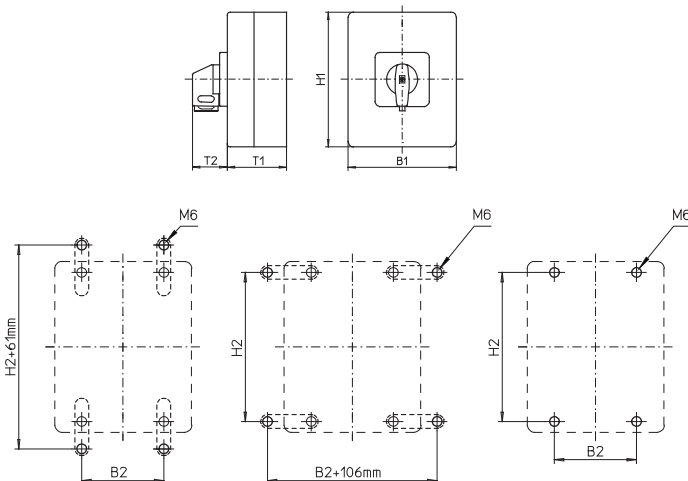

Zugehörige Befestigungslaschen bitte getrennt bestellen, siehe Seite 148.

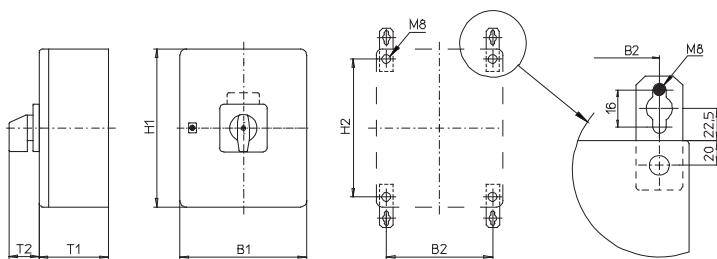

Zugehörige Befestigungslaschen bitte getrennt bestellen, siehe Seite 148.

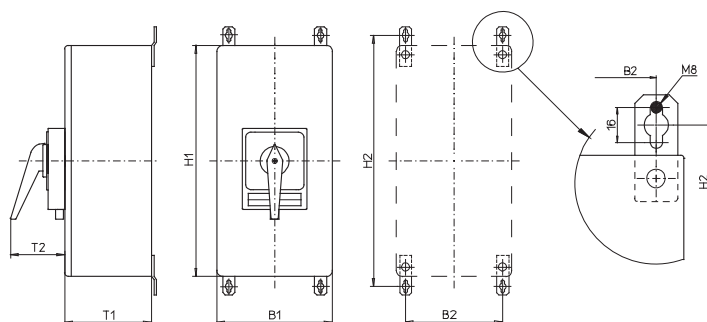

Zugehörige Befestigungslaschen sind im Lieferumfang enthalten.

Stahlgehäuse **200 × 150 × 120 mm**
und **300 × 250 × 150 mm**:

Typen H216 / H220 / H226 / H233:

Bauform	H1	B1	T1	T2	H2	B2
186V1	200	150	120	39	182	85
188M1	200	150	120	39	182	85
188V1	200	150	120	39	182	85

Typen B240 / B250 / B263:

Bauform	H1	B1	T1	T2	H2	B2
186V1	300	250	150	39	282	185
188M1	300	250	150	52	282	185
188V1	300	250	150	39	282	185

Typen H406 / H408 / H410 / H412:

Bauform	H1	B1	T1	T2	H2	B2
186H1	300	250	150	83	282	185
186M1	300	250	150	52	282	185
189H1	300	250	150	83	282	185

Stahlgehäuse **400 × 300 × 155 mm**:

Typen H406 / H408 / H410 / H412:

Bauform	H1	B1	T1	T2	H2	B2
181M1	400	300	155	52	360	260
183H1	400	300	155	45	282	185

Flanschplatte unten

Stahlgehäuse **500 × 400 × 300 mm /**
600 × 400 × 300 mm / 800 × 400 × 300 mm:

Typ K616:

Bauform	H1	B1	T1	T2	H2	B2
186H1	500	400	300	83	545	360

Typ K830:

Bauform	H1	B1	T1	T2	H2	B2
186H1	600	400	300	93	645	360
286H1	800	400	300	93	845	360

Weitere Schaltprogramme und zugehörige Abmessungen für Typen K auf Anfrage.

Flanschplatte unten







Lasttrennschalter

Umschalter Gekapselte Schalter mit Edelstahlgehäuse

Umschalter

- Gekapselte Schalter mit Edelstahlgehäuse (gebürstet)
- Deckelverriegelung in Stellung 1 und 2
- 3- bis 4-polig
- 20 A bis 125 A
- IP66

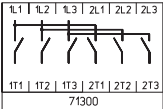
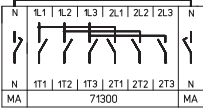

Schaltprogramm	Bemessungsdaten (IEC 60947) Betriebs- Betriebsleistung strom I _e (bei 380–440 V)			Gehäuse- abmessungen (H × B × T) (mm)	M-Griff silber/schwarz	Griffverriegelung V-Griff silber/schwarz	Griffverriegelung V-Griff silber/schwarz
	AC-21A (A)	AC-23A (kW)	AC-3 (kW)		  IP66	  Nullstellung verriegelbar IP66	  alle Stellungen verriegelbar IP66
					Bestellnummer	Bestellnummer	Bestellnummer
71300 – 3-polig – ohne Hilfskontakte 	20	5,5	3,7	200 × 150 × 120	H216-71300-198M1	H216-71300-196V1	H216-71300-198V1
	25	7,5	5,5	200 × 150 × 120	H220-71300-198M1	H220-71300-196V1	H220-71300-198V1
	32	11	7,5	200 × 150 × 120	H226-71300-198M1	H226-71300-196V1	H226-71300-198V1
	40	15	11	200 × 150 × 120	H233-71300-198M1	H233-71300-196V1	H233-71300-198V1
	40	15	11	300 × 250 × 150	B240-71300-198M1	B240-71300-196V1	B240-71300-198V1
	50	18,5	15	300 × 250 × 150	B250-71300-198M1	B250-71300-196V1	B250-71300-198V1
	63	22	18,5	300 × 250 × 150	B263-71300-198M1	B263-71300-196V1	B263-71300-198V1
	63	22	18,5	300 × 250 × 150	H406-71300-196M1*	–	–
	80	30	22	300 × 250 × 150	H408-71300-196M1	–	–
	100	37	30	300 × 250 × 150	H410-71300-196M1	–	–
125	45	37	300 × 250 × 150	H412-71300-196M1	–	–	
71500 – 4-polig – ohne Hilfskontakte – Neutralleiter voreilend – mit Verbindungsbrücke neutral 	20	5,5	3,7	200 × 150 × 120	H216-71500-198M1	H216-71500-196V1	H216-71500-198V1
	25	7,5	5,5	200 × 150 × 120	H220-71500-198M1	H220-71500-196V1	H220-71500-198V1
	32	11	7,5	200 × 150 × 120	H226-71500-198M1	H226-71500-196V1	H226-71500-198V1
	40	15	11	200 × 150 × 120	H233-71500-198M1	H233-71500-196V1	H233-71500-198V1
	40	15	11	300 × 250 × 150	B240-71500-198M1	B240-71500-196V1	B240-71500-198V1
	50	18,5	15	300 × 250 × 150	B250-71500-198M1	B250-71500-196V1	B250-71500-198V1
	63	22	18,5	300 × 250 × 150	B263-71500-198M1	B263-71500-196V1	B263-71500-198V1
	63	22	18,5	300 × 250 × 150	H406-71500-196M1*	–	–
	80	30	22	300 × 250 × 150	H408-71500-196M1	–	–
	100	37	30	300 × 250 × 150	H410-71500-196M1	–	–
125	45	37	300 × 250 × 150	H412-71500-196M1	–	–	

* größerer Anschlussquerschnitt, siehe Seite 154

Weitere Schaltprogramme ab Seite 132.

Abmessungen in mm:

Aufbau der Bestellnummer		
Typ	Schaltprogramm	Bauform
B263	71300	198V1
Best.-Nr.	B263-71300-198V1	

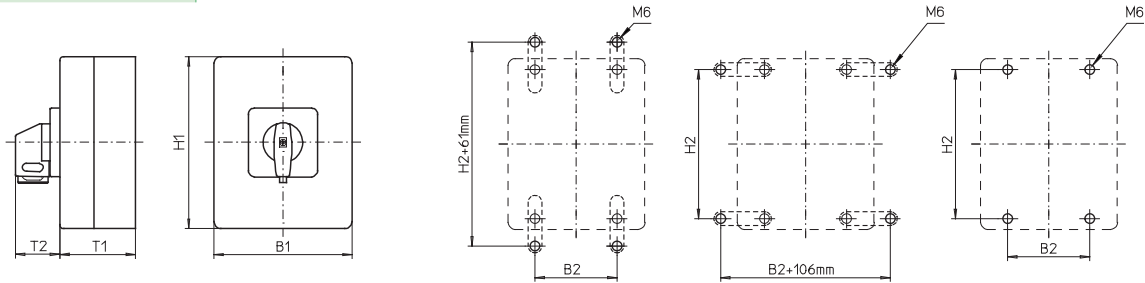

Zugehörige Befestigungslaschen bitte getrennt bestellen, siehe Seite 148.

Typen H216 / H220 / H226 / H233:

Bauform	H1	B1	T1	T2	H2	B2
196V1	200	150	120	39	182	85
198M1	200	150	120	39	182	85
198V1	200	150	120	39	182	85

Typen H406 / H408 / H410 / H412:

Bauform	H1	B1	T1	T2	H2	B2
196M1	300	250	150	52	282	185
196V1	300	250	150	39	282	185
198V1	300	250	150	39	282	185

Typen B240 / B250 / B263:

Bauform	H1	B1	T1	T2	H2	B2
196V1	300	250	150	39	282	185
198M1	300	250	150	52	282	185
198V1	300	250	150	39	282	185

Lasttrennschalter

Technische Informationen Schaltbilder

Schaltbilder 41200–41311

Haupt-/Notausschalter · Hauptschalter · Ein-/Ausschalter, 2-polig

41200	1/L1 3/L2 5/L3
SMD	41200

Schaltprogramm 41200
2-polig ohne Hilfskontakte

41211	1/L1 3/L2 5/L3	21 13
SMD	41200	MB

Schaltprogramm 41211
2-polig mit 2 Hilfskontakten
1 Spätschließer/Frühöffner + 1 Öffner

41220	1/L1 3/L2 5/L3	33 43
SMD	41200	MD

Schaltprogramm 41220
2-polig mit 2 Hilfskontakten
2 Spätschließer/Frühöffner

41222	24 32	1/L1 3/L2 5/L3	21 13
SMD	MC	41200	MB

Schaltprogramm 41222
2-polig mit 4 Hilfskontakten
2 Spätschließer/Frühöffner + 2 Öffner

41231	44 34	1/L1 3/L2 5/L3	21 13
SMD	MD	41200	MB

Schaltprogramm 41231
2-polig mit 4 Hilfskontakten
3 Spätschließer/Frühöffner + 1 Öffner

41240	64 54	1/L1 3/L2 5/L3	33 43
SMD	ME	41200	MD

Schaltprogramm 41240
2-polig mit 4 Hilfskontakten
4 Spätschließer/Frühöffner

Haupt-/Notausschalter · Hauptschalter · Ein-/Ausschalter, 3-polig

41300	1/L1 3/L2 5/L3
SMD	41300

Schaltprogramm 41300
3-polig ohne Hilfskontakte

41311	1/L1 3/L2 5/L3	21 13
SMD	41300	MB

Schaltprogramm 41311
3-polig mit 2 Hilfskontakten
1 Spätschließer/Frühöffner + 1 Öffner

Schaltbilder 41320–41420

Haupt-/Notausschalter · Hauptschalter · Ein-/Ausschalter, 3-polig

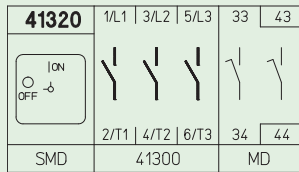

Schaltprogramm 41320
3-polig mit 2 Hilfskontakten
2 Spätschließer/Frühöffner

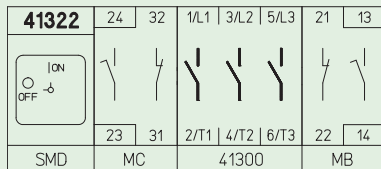

Schaltprogramm 41322
3-polig mit 4 Hilfskontakten
2 Spätschließer/Frühöffner + 2 Öffner

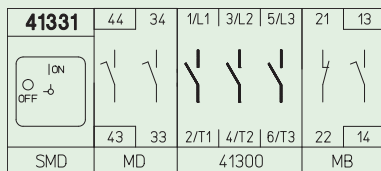

Schaltprogramm 41331
3-polig mit 4 Hilfskontakten
3 Spätschließer/Frühöffner + 1 Öffner

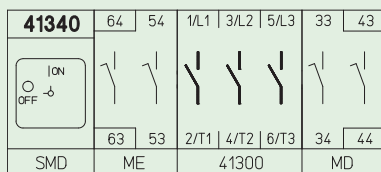

Schaltprogramm 41340
3-polig mit 4 Hilfskontakten
4 Spätschließer/Frühöffner

Haupt-/Notausschalter · Hauptschalter · Ein-/Ausschalter, 4-polig

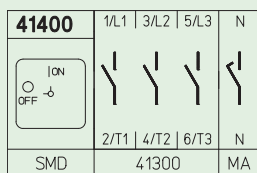

Schaltprogramm 41400
4-polig ohne Hilfskontakte
Neutralleiter voreilend

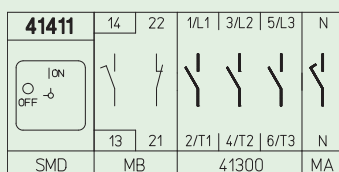

Schaltprogramm 41411
4-polig mit 2 Hilfskontakten
1 Spätschließer/Frühöffner + 1 Öffner
Neutralleiter voreilend

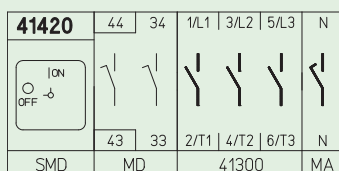

Schaltprogramm 41420
4-polig mit 2 Hilfskontakten
2 Spätschließer/Frühöffner
Neutralleiter voreilend

Lasttrennschalter

Technische Informationen Schaltbilder

Schaltbilder 41600–41800

Haupt-/Notausschalter · Hauptschalter · Ein-/Ausschalter, 6-polig

41600	1L1 1L2 1L3 2L1 2L2 2L3
SMD	1T1 1T2 1T3 2T1 2T2 2T3 41600

Schaltprogramm 41600
6-polig ohne Hilfskontakte

41611	1L1 1L2 1L3 2L1 2L2 2L3	21 13
SMD	1T1 1T2 1T3 2T1 2T2 2T3 41600	22 14 MB

Schaltprogramm 41611
6-polig mit 2 Hilfskontakten
1 Spätschließer/Frühöffner + 1 Öffner

41620	1L1 1L2 1L3 2L1 2L2 2L3	33 43
SMD	1T1 1T2 1T3 2T1 2T2 2T3 41600	34 44 MD

Schaltprogramm 41620
6-polig mit 2 Hilfskontakten
2 Spätschließer/Frühöffner

41622	24 32	1L1 1L2 1L3 2L1 2L2 2L3	21 13
SMD	23 31 MC	1T1 1T2 1T3 2T1 2T2 2T3 41600	22 14 MB

Schaltprogramm 41622
6-polig mit 4 Hilfskontakten
2 Spätschließer/Frühöffner + 2 Öffner

41631	44 34	1L1 1L2 1L3 2L1 2L2 2L3	21 13
SMD	43 33 MD	1T1 1T2 1T3 2T1 2T2 2T3 41600	22 14 MB

Schaltprogramm 41631
6-polig mit 4 Hilfskontakten
3 Spätschließer/Frühöffner + 1 Öffner

41640	64 54	1L1 1L2 1L3 2L1 2L2 2L3	33 43
SMD	63 53 ME	1T1 1T2 1T3 2T1 2T2 2T3 41600	34 44 MD

Schaltprogramm 41640
6-polig mit 4 Hilfskontakten
4 Spätschließer/Frühöffner

Ein-/Ausschalter, 8-polig

41800	N	1L1 1L2 1L3 2L1 2L2 2L3	N
SMD	N MA	1T1 1T2 1T3 2T1 2T2 2T3 41600	N MA

Schaltprogramm 41800
8-polig ohne Hilfskontakte
2 Neutralleiter voreilend

Schaltbilder 42400–42800

Haupt-/Notausschalter · Hauptschalter · Ein-/Ausschalter, mit Hauptkontaktmodul

42400	1/L1 3/L2 5/L3	7
SMD	2/T1 4/T2 6/T3	8
	41300	MO

Schaltprogramm 42400
4-polig ohne Hilfskontakte

42411	14 22	1/L1 3/L2 5/L3	7
SMD	13 21	2/T1 4/T2 6/T3	8
	MB	41300	MO

Schaltprogramm 42411
4-polig mit 2 Hilfskontakten
1 Spätschließer/Frühöffner + 1 Öffner

42420	44 34	1/L1 3/L2 5/L3	7
SMD	43 33	2/T1 4/T2 6/T3	8
	MD	41300	MO

Schaltprogramm 42420
4-polig mit 2 Hilfskontakten
2 Spätschließer/Frühöffner

42500	9	1/L1 3/L2 5/L3	7
SMD	0	2/T1 4/T2 6/T3	8
	MP	41300	MO

Schaltprogramm 42500
5-polig ohne Hilfskontakte

42700	1/L1 1/L2 1/L3	2/L1 2/L2 2/L3	7
SMD	1/T1 1/T2 1/T3	2/T1 2/T2 2/T3	8
	41600		MO

Schaltprogramm 42700
7-polig ohne Hilfskontakte

42711	14 22	1/L1 1/L2 1/L3	2/L1 2/L2 2/L3	7
SMD	13 21	1/T1 1/T2 1/T3	2/T1 2/T2 2/T3	8
	MB	41600		MO

Schaltprogramm 42711
7-polig mit 2 Hilfskontakten
1 Spätschließer/Frühöffner + 1 Öffner

42720	44 34	1/L1 1/L2 1/L3	2/L1 2/L2 2/L3	7
SMD	43 33	1/T1 1/T2 1/T3	2/T1 2/T2 2/T3	8
	MD	41600		MO

Schaltprogramm 42720
7-polig mit 2 Hilfskontakten
2 Spätschließer/Frühöffner

42800	9	1/L1 1/L2 1/L3	2/L1 2/L2 2/L3	7
SMD	0	1/T1 1/T2 1/T3	2/T1 2/T2 2/T3	8
	MP	41600		MO

Schaltprogramm 42800
8-polig ohne Hilfskontakte

Lasttrennschalter

Technische Informationen Schaltbilder

Schaltbilder 45300–47200

Haupt-/Notausschalter · Hauptschalter · Ein-/Ausschalter, mit N- und PE-Klemme

45300	PE	1/L1	3/L2	5/L3	N
					
	PE	2/T1	4/T2	6/T3	N
SMD	MG	41300			MF

Schaltprogramm 45300
3-polig ohne Hilfskontakte
mit N- und PE-Klemmen

45311	PE	N	1/L1	3/L2	5/L3	21	13
							
	PE	N	2/T1	4/T2	6/T3	22	14
SMD	MG	MF	41300			MB	

Schaltprogramm 45311
3-polig mit 2 Hilfskontakten
1 Spätschließer/Frühöffner + 1 Öffner
mit N- und PE-Klemme

45320	PE	N	1/L1	3/L2	5/L3	33	43
							
	PE	N	2/T1	4/T2	6/T3	34	44
SMD	MG	MF	41300			MD	

Schaltprogramm 45320
3-polig mit 2 Hilfskontakten
2 Spätschließer/Frühöffner
mit N- und PE-Klemme

Haupt-/Notausschalter · Hauptschalter · Ein-/Ausschalter, mit N-Klemme

46300	1/L1	3/L2	5/L3	N
				
	2/T1	4/T2	6/T3	N
SMD	41300			MF

Schaltprogramm 46300
3-polig ohne Hilfskontakte
mit N-Klemme

46311	14	22	1/L1	3/L2	5/L3	N
						
	13	21	2/T1	4/T2	6/T3	N
SMD	MB		41300			MF

Schaltprogramm 46311
3-polig mit 2 Hilfskontakten
1 Spätschließer/Frühöffner + 1 Öffner
mit N-Klemme

46320	44	34	1/L1	3/L2	5/L3	N
						
	43	33	2/T1	4/T2	6/T3	N
SMD	MD		41300			MF

Schaltprogramm 46320
3-polig mit 2 Hilfskontakten
2 Spätschließer/Frühöffner
mit N-Klemme

Haupt-/Notausschalter · Hauptschalter · Ein-/Ausschalter, mit PE-Klemme

47200	1/L1	3/L2	5/L3	PE
				
	2/T1	4/T2	6/T3	PE
SMD	41200			MG

Schaltprogramm 47200
2-polig ohne Hilfskontakte
mit PE-Klemme

Schaltbilder 47211–71200

Haupt-/Notausschalter · Hauptschalter · Ein-/Ausschalter, mit PE-Klemme

47211	14	22	1/L1	3/L2	5/L3	PE
	13	21	2/T1	4/T2	6/T3	PE
SMD	MB	41200		MG		

Schaltprogramm 47211
 2-polig mit 2 Hilfskontakten
 1 Spätschließer/Frühöffner + 1 Öffner
 mit PE-Klemme

47220	44	34	1/L1	3/L2	5/L3	PE
	43	33	2/T1	4/T2	6/T3	PE
SMD	MD	41200		MG		

Schaltprogramm 47220
 2-polig mit 2 Hilfskontakten
 2 Spätschließer/Frühöffner
 mit PE-Klemme

47300	1/L1	3/L2	5/L3	PE
	2/T1	4/T2	6/T3	PE
SMD	41300		MG	

Schaltprogramm 47300
 3-polig ohne Hilfskontakte
 mit PE-Klemme

47311	14	22	1/L1	3/L2	5/L3	PE
	13	21	2/T1	4/T2	6/T3	PE
SMD	MB	41300		MG		

Schaltprogramm 47311
 3-polig mit 2 Hilfskontakten
 1 Spätschließer/Frühöffner + 1 Öffner
 mit PE-Klemme

47320	44	34	1/L1	3/L2	5/L3	PE
	43	33	2/T1	4/T2	6/T3	PE
SMD	MD	41300		MG		

Schaltprogramm 47320
 3-polig mit 2 Hilfskontakten
 2 Spätschließer/Frühöffner
 mit PE-Klemme

47400	N	1/L1	3/L2	5/L3	PE
	N	2/T1	4/T2	6/T3	PE
SMD	MA	41300		MG	

Schaltprogramm 47400
 4-polig ohne Hilfskontakte
 Neutralleiter voreilend
 mit PE-Klemme

48400	9	1/L1	3/L2	5/L3	PE
	0	2/T1	4/T2	6/T3	PE
SMD	MP	41300		MG	

Schaltprogramm 48400
 4-polig ohne Hilfskontakte
 mit PE-Klemme

Umschalter, 2-polig

71200	1L1	1L2	1L3	2L1	2L2	2L3
	1T1	1T2	1T3	2T1	2T2	2T3
SMD	71200					

Schaltprogramm 71200
 2-polig ohne Hilfskontakte

Lasttrennschalter

Technische Informationen Schaltbilder

Schaltbilder 71201–71222

Umschalter, 2-polig

71201	1L1 1L2 1L3 2L1 2L2 2L3	21 13	Stellung/Position
SMD	1T1 1T2 1T3 2T1 2T2 2T3	22 14	MB 2
	71200		

Schaltprogramm 71201
 2-polig mit 2 Hilfskontakten
 In Stellung 2: 1 Spätschließer/Frühöffner + 1 Öffner

71202	1L1 1L2 1L3 2L1 2L2 2L3	33 43	Stellung/Position
SMD	1T1 1T2 1T3 2T1 2T2 2T3	34 44	MD 2
	71200		

Schaltprogramm 71202
 2-polig mit 2 Hilfskontakten
 In Stellung 2: 2 Spätschließer/Frühöffner

71210	14 22	1L1 1L2 1L3 2L1 2L2 2L3	Stellung/Position
SMD	13 21	1T1 1T2 1T3 2T1 2T2 2T3	1 MB 71200

Schaltprogramm 71210
 2-polig mit 2 Hilfskontakten
 In Stellung 1: 1 Spätschließer/Frühöffner + 1 Öffner

71211	14 22	1L1 1L2 1L3 2L1 2L2 2L3	31 23	Stellung/Position
SMD	13 21	1T1 1T2 1T3 2T1 2T2 2T3	32 24	1 MB 71200 MC 2

Schaltprogramm 71211
 2-polig mit 4 Hilfskontakten
 In Stellung 1: 1 Spätschließer/Frühöffner + 1 Öffner
 In Stellung 2: 1 Spätschließer/Frühöffner + 1 Öffner

71212	14 22	1L1 1L2 1L3 2L1 2L2 2L3	33 43	Stellung/Position
SMD	13 21	1T1 1T2 1T3 2T1 2T2 2T3	34 44	1 MB 71200 MD 2

Schaltprogramm 71212
 2-polig mit 4 Hilfskontakten
 In Stellung 1: 1 Spätschließer/Frühöffner + 1 Öffner
 In Stellung 2: 2 Spätschließer/Frühöffner

71220	44 34	1L1 1L2 1L3 2L1 2L2 2L3	Stellung/Position
SMD	43 33	1T1 1T2 1T3 2T1 2T2 2T3	1 MD 71200

Schaltprogramm 71220
 2-polig mit 2 Hilfskontakten
 In Stellung 1: 2 Spätschließer/Frühöffner

71221	44 34	1L1 1L2 1L3 2L1 2L2 2L3	21 13	Stellung/Position
SMD	43 33	1T1 1T2 1T3 2T1 2T2 2T3	22 14	1 MD 71200 MB 2

Schaltprogramm 71221
 2-polig mit 4 Hilfskontakten
 In Stellung 1: 2 Spätschließer/Frühöffner
 In Stellung 2: 1 Spätschließer/Frühöffner + 1 Öffner

71222	44 34	1L1 1L2 1L3 2L1 2L2 2L3	53 63	Stellung/Position
SMD	43 33	1T1 1T2 1T3 2T1 2T2 2T3	54 64	1 MD 71200 ME 2

Schaltprogramm 71222
 2-polig mit 4 Hilfskontakten
 In Stellung 1: 2 Spätschließer/Frühöffner
 In Stellung 2: 2 Spätschließer/Frühöffner

Schaltbilder 71300–71321

Umschalter, 3-polig

71300	1L1 1L2 1L3 2L1 2L2 2L3
	1T1 1T2 1T3 2T1 2T2 2T3
SMD	71300

Schaltprogramm 71300
3-polig ohne Hilfskontakte

71301	1L1 1L2 1L3 2L1 2L2 2L3	21 13	Stellung/Position
		22 14	
	1T1 1T2 1T3 2T1 2T2 2T3		
SMD	71300	MB	2

Schaltprogramm 71301
3-polig mit 2 Hilfskontakten
In Stellung 2: 1 Spätschließer/Frühöffner + 1 Öffner

71302	1L1 1L2 1L3 2L1 2L2 2L3	33 43	Stellung/Position
		34 44	
	1T1 1T2 1T3 2T1 2T2 2T3		
SMD	71300	MD	2

Schaltprogramm 71302
3-polig mit 2 Hilfskontakten
In Stellung 2: 2 Spätschließer/Frühöffner

71310	14 22	1L1 1L2 1L3 2L1 2L2 2L3	Stellung/Position
	13 21		
		1T1 1T2 1T3 2T1 2T2 2T3	
SMD	1 MB	71300	2

Schaltprogramm 71310
3-polig mit 2 Hilfskontakten
In Stellung 1: 1 Spätschließer/Frühöffner + 1 Öffner

71311	14 22	1L1 1L2 1L3 2L1 2L2 2L3	31 23	Stellung/Position
	13 21		32 24	
		1T1 1T2 1T3 2T1 2T2 2T3		
SMD	1 MB	71300	MC	2

Schaltprogramm 71311
3-polig mit 4 Hilfskontakten
In Stellung 1: 1 Spätschließer/Frühöffner + 1 Öffner
In Stellung 2: 1 Spätschließer/Frühöffner + 1 Öffner

71312	14 22	1L1 1L2 1L3 2L1 2L2 2L3	33 43	Stellung/Position
	13 21		34 44	
		1T1 1T2 1T3 2T1 2T2 2T3		
SMD	1 MB	71300	MD	2

Schaltprogramm 71312
3-polig mit 4 Hilfskontakten
In Stellung 1: 1 Spätschließer/Frühöffner + 1 Öffner
In Stellung 2: 2 Spätschließer/Frühöffner

71320	44 34	1L1 1L2 1L3 2L1 2L2 2L3	Stellung/Position
	43 33		
		1T1 1T2 1T3 2T1 2T2 2T3	
SMD	1 MD	71300	

Schaltprogramm 71320
3-polig mit 2 Hilfskontakten
In Stellung 1: 2 Spätschließer/Frühöffner

71321	44 34	1L1 1L2 1L3 2L1 2L2 2L3	21 13	Stellung/Position
	43 33		22 14	
		1T1 1T2 1T3 2T1 2T2 2T3		
SMD	1 MD	71300	MB	2

Schaltprogramm 71321
3-polig mit 4 Hilfskontakten
In Stellung 1: 2 Spätschließer/Frühöffner
In Stellung 2: 1 Spätschließer/Frühöffner + 1 Öffner

Lasttrennschalter

Technische Informationen Schaltbilder

Schaltbilder 71322–73500

Umschalter, 3-polig

71322	44	34	1L1	1L2	1L3	2L1	2L2	2L3	53	63	Stellung/Position	
SMD	1	MD	71300						ME	2	Stellung/Position	
			43	33	1T1	1T2	1T3	2T1	2T2	2T3	54	64

Schaltprogramm 71322
 3-polig mit 4 Hilfskontakten
 In Stellung 1: 2 Spätschließer/Frühöffner
 In Stellung 2: 2 Spätschließer/Frühöffner

Umschalter, 4-polig

71400	N	1L1	1L2	1L3	2L1	2L2	2L3	N	
SMD	MA	71300						MA	
		N	1T1	1T2	1T3	2T1	2T2	2T3	N

Schaltprogramm 71400
 4-polig ohne Hilfskontakte
 Neutralleiter voreilend

71500	N	1L1	1L2	1L3	2L1	2L2	2L3	N	
SMD	MA	71300						MA	
		N	1T1	1T2	1T3	2T1	2T2	2T3	N

Schaltprogramm 71500
 4-polig ohne Hilfskontakte
 Neutralleiter voreilend
 mit Verbindungsbrücke neutral

73500	9	1L1	1L2	1L3	2L1	2L2	2L3	7	
SMD	MP	71300						MO	
		0	1T1	1T2	1T3	2T1	2T2	2T3	8

Schaltprogramm 73500
 4-polig ohne Hilfskontakte
 mit Verbindungsbrücke Hauptkontaktmodule

Umschalter, 3- und 4-polig

72300	1L1	1L2	1L3	2L1	2L2	2L3
SMD	72300					
	1T1	1T2	1T3	2T1	2T2	2T3

Schaltprogramm 72300
 3-polig ohne Hilfskontakte
 getrennte Kontakte

72400	9	1L1	1L2	1L3	2L1	2L2	2L3	7	
SMD	MP	72300						MO	
		0	1T1	1T2	1T3	2T1	2T2	2T3	8

Schaltprogramm 72400
 4-polig ohne Hilfskontakte
 getrennte Kontakte

73400	9	1L1	1L2	1L3	2L1	2L2	2L3	7	
SMD	MP	71300						MO	
		0	1T1	1T2	1T3	2T1	2T2	2T3	8

Schaltprogramm 73400
 3-polig ohne Hilfskontakte
 ohne Verbindungsbrücke Hauptkontaktmodule

Zusatzmodule zum nachträglichen Anbau an Schalter 41300/41600/71300

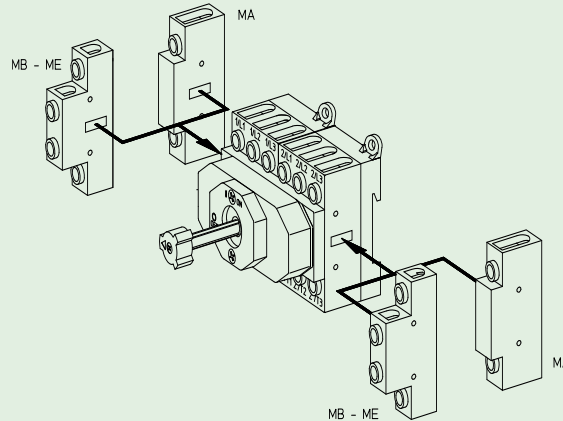

Schaltprogramm		Typ	Bestellnummer	
Modul links	Modul rechts		Fronteinbau	Bodeneinbau
Neutralleitermodul MA Frühschließer		H216 H220 H226 H233 B240 B250 B263 H406 H408 H410 H412	MAH2-16A01 MAH2-20A01 MAH2-26A01 MAH2-33A01 MAB2-40A01 MAB2-50A01 MAB2-63A01 MAH4-06A01 MAH4-08A01 MAH4-10A01 MAH4-12A01	MAH2-16A02 MAH2-20A02 MAH2-26A02 MAH2-33A02 MAB2-40A02 MAB2-50A02 MAB2-63A02 MAH4-06A02 MAH4-08A02 MAH4-10A02 MAH4-12A02
N-Klemme MF		H216 H220 H226 H233 B240 B250 B263 H406 H408 H410 H412	MFH2-00A01 MFH2-00A01 MFH2-00A01 MFH2-00A01 MFB2-00A01 MFB2-00A01 MFB2-00A01 MFH4-00A01 MFH4-00A01 MFH4-00A01 MFH4-00A01	MFH2-00A02 MFH2-00A02 MFH2-00A02 MFH2-00A02 MFB2-00A02 MFB2-00A02 MFB2-00A02 MFH4-00A02 MFH4-00A02 MFH4-00A02 MFH4-00A02
PE-Klemme MG		H216 H220 H226 H233 B240 B250 B263 H406 H408 H410 H412	MGH2-00A01 MGH2-00A01 MGH2-00A01 MGH2-00A01 MGB2-00A01 MGB2-00A01 MGB2-00A01 MGH4-00A01 MGH4-00A01 MGH4-00A01 MGH4-00A01	MGH2-00A02 MGH2-00A02 MGH2-00A02 MGH2-00A02 MGB2-00A02 MGB2-00A02 MGB2-00A02 MGH4-00A02 MGH4-00A02 MGH4-00A02 MGH4-00A02
Hauptkontaktmodul MO gleichzeitig schließend		H216 H220 H226 H233 B240 B250 B263 H406 H408 H410 H412	MOH2-16A01 MOH2-20A01 MOH2-26A01 MOH2-33A01 MOB2-40A01 MOB2-50A01 MOB2-63A01 MOH4-06A01 MOH4-08A01 MOH4-10A01 MOH4-12A01	MOH2-16A02 MOH2-20A02 MOH2-26A02 MOH2-33A02 MOB2-40A02 MOB2-50A02 MOB2-63A02 MOH4-06A02 MOH4-08A02 MOH4-10A02 MOH4-12A02

Lasttrennschalter

Technische Informationen Zusatzmodule

Zusatzmodule zum nachträglichen Anbau an Schalter 41300/41600/71300

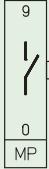
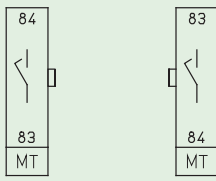
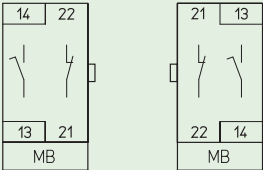
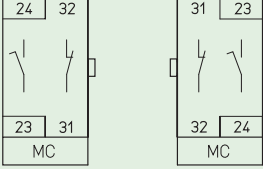
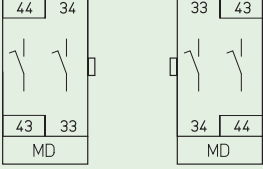
Schaltprogramm		Typ	Bestellnummer Fronteinbau	Bestellnummer Bodeneinbau
Modul links	Modul rechts			
Hauptkontaktmodul MP gleichzeitig schließend		H216	MPH2-16A01	MPH2-16A02
		H220	MPH2-20A01	MPH2-20A02
		H226	MPH2-26A01	MPH2-26A02
		H233	MPH2-33A01	MPH2-33A02
		B240	MPB2-40A01	MPB2-40A02
		B250	MPB2-50A01	MPB2-50A02
		B263	MPB2-63A01	MPB2-63A02
		H406	MPH4-06A01	MPH4-06A02
		H408	MPH4-08A01	MPH4-08A02
		H410	MPH4-10A01	MPH4-10A02
		H412	MPH4-12A01	MPH4-12A02
Hauptkontaktmodul MT 1 Frühschließer 20A		H216	MTH2-20A01	MTH2-20A02
		H220	MTH2-20A01	MTH2-20A02
		H226	MTH2-20A01	MTH2-20A02
		H233	MTH2-20A01	MTH2-20A02
		B240	MTB2-20A01	MTB2-20A02
		B250	MTB2-20A01	MTB2-20A02
		B263	MTB2-20A01	MTB2-20A02
		H406	MTH4-20A01	MTH4-20A02
		H408	MTH4-20A01	MTH4-20A02
		H410	MTH4-20A01	MTH4-20A02
		H412	MTH4-20A01	MTH4-20A02
Hilfskontaktmodul MB 1 Spätschließer/Frühöffner + 1 Öffner		H216	MBH2-11A01	MBH2-11A02
		H220	MBH2-11A01	MBH2-11A02
		H226	MBH2-11A01	MBH2-11A02
		H233	MBH2-11A01	MBH2-11A02
		B240	MBH4-11A01	MBH4-11A02
		B250	MBH4-11A01	MBH4-11A02
		B263	MBH4-11A01	MBH4-11A02
		H406	MBH4-11A01	MBH4-11A02
		H408	MBH4-11A01	MBH4-11A02
		H410	MBH4-11A01	MBH4-11A02
		H412	MBH4-11A01	MBH4-11A02
Hilfskontaktmodul MC 1 Spätschließer/Frühöffner + 1 Öffner		H216	MCH2-11A01	MCH2-11A02
		H220	MCH2-11A01	MCH2-11A02
		H226	MCH2-11A01	MCH2-11A02
		H233	MCH2-11A01	MCH2-11A02
		B240	MCH4-11A01	MCH4-11A02
		B250	MCH4-11A01	MCH4-11A02
		B263	MCH4-11A01	MCH4-11A02
		H406	MCH4-11A01	MCH4-11A02
		H408	MCH4-11A01	MCH4-11A02
		H410	MCH4-11A01	MCH4-11A02
		H412	MCH4-11A01	MCH4-11A02
Hilfskontaktmodul MD 2 Spätschließer/Frühöffner		H216	MDH2-20A01	MDH2-20A02
		H220	MDH2-20A01	MDH2-20A02
		H226	MDH2-20A01	MDH2-20A02
		H233	MDH2-20A01	MDH2-20A02
		B240	MDH4-20A01	MDH4-20A02
		B250	MDH4-20A01	MDH4-20A02
		B263	MDH4-20A01	MDH4-20A02
		H406	MDH4-20A01	MDH4-20A02
		H408	MDH4-20A01	MDH4-20A02
		H410	MDH4-20A01	MDH4-20A02
		H412	MDH4-20A01	MDH4-20A02

Zusatzmodule zum nachträglichen Anbau an Schalter 41300 /41600/71300

Schaltprogramm		Typ	Bestellnummer Fronteinbau	Bestellnummer Bodeneinbau
Modul links	Modul rechts			
Hilfskontaktmodul ME 2 Spätschließer/Frühöffner		H216	MEH2-20A01	MEH2-20A02
		H220	MEH2-20A01	MEH2-20A02
		H226	MEH2-20A01	MEH2-20A02
		H233	MEH2-20A01	MEH2-20A02
		B240	MEH4-20A01	MEH4-20A02
		B250	MEH4-20A01	MEH4-20A02
		B263	MEH4-20A01	MEH4-20A02
		H406	MEH4-20A01	MEH4-20A02
		H408	MEH4-20A01	MEH4-20A02
		H410	MEH4-20A01	MEH4-20A02
		H412	MEH4-20A01	MEH4-20A02
Hilfskontaktmodul MK 1 Spätschließer/Frühöffner + 1 Öffner Kontakte mit Goldauflage 5 µm		H216	MKH2-11A01	MKH2-11A02
		H220	MKH2-11A01	MKH2-11A02
		H226	MKH2-11A01	MKH2-11A02
		H233	MKH2-11A01	MKH2-11A02
		B240	MKH4-11A01	MKH4-11A02
		B250	MKH4-11A01	MKH4-11A02
		B263	MKH4-11A01	MKH4-11A02
		H406	MKH4-11A01	MKH4-11A02
		H408	MKH4-11A01	MKH4-11A02
		H410	MKH4-11A01	MKH4-11A02
		H412	MKH4-11A01	MKH4-11A02
Hilfskontaktmodul ML 1 Spätschließer/Frühöffner + 1 Öffner Kontakte mit Goldauflage 5 µm		H216	MLH2-11A01	MLH2-11A02
		H220	MLH2-11A01	MLH2-11A02
		H226	MLH2-11A01	MLH2-11A02
		H233	MLH2-11A01	MLH2-11A02
		B240	MLH4-11A01	MLH4-11A02
		B250	MLH4-11A01	MLH4-11A02
		B263	MLH4-11A01	MLH4-11A02
		H406	MLH4-11A01	MLH4-11A02
		H408	MLH4-11A01	MLH4-11A02
		H410	MLH4-11A01	MLH4-11A02
		H412	MLH4-11A01	MLH4-11A02
Hilfskontaktmodul MM 2 Spätschließer/Frühöffner Kontakte mit Goldauflage 5 µm		H216	MMH2-20A01	MMH2-20A02
		H220	MMH2-20A01	MMH2-20A02
		H226	MMH2-20A01	MMH2-20A02
		H233	MMH2-20A01	MMH2-20A02
		B240	MMH4-20A01	MMH4-20A02
		B250	MMH4-20A01	MMH4-20A02
		B263	MMH4-20A01	MMH4-20A02
		H406	MMH4-20A01	MMH4-20A02
		H408	MMH4-20A01	MMH4-20A02
		H410	MMH4-20A01	MMH4-20A02
		H412	MMH4-20A01	MMH4-20A02
Hilfskontaktmodul MN 2 Spätschließer/Frühöffner Kontakte mit Goldauflage 5 µm		H216	MNH2-20A01	MNH2-20A02
		H220	MNH2-20A01	MNH2-20A02
		H226	MNH2-20A01	MNH2-20A02
		H233	MNH2-20A01	MNH2-20A02
		B240	MNH4-20A01	MNH4-20A02
		B250	MNH4-20A01	MNH4-20A02
		B263	MNH4-20A01	MNH4-20A02
		H406	MNH4-20A01	MNH4-20A02
		H408	MNH4-20A01	MNH4-20A02
		H410	MNH4-20A01	MNH4-20A02
		H412	MNH4-20A01	MNH4-20A02

Lasttrennschalter

Technische Informationen Zusatzmodule

Zusatzmodule zum nachträglichen Anbau an Schalter 41300/41600/71300

Schaltprogramm		Typ	Bestellnummer Fronteinbau	Bestellnummer Bodeneinbau											
Modul links	Modul rechts														
Hilfskontaktmodul MR 1 Schließer + 1 Öffner		H216 H220 H226 H233 B240 B250 B263	MRH2-11A01 MRH2-11A01 MRH2-11A01 MRH2-11A01 MRB2-11A01 MRB2-11A01 MRB2-11A01	MRH2-11A02 MRH2-11A02 MRH2-11A02 MRH2-11A02 MRB2-11A02 MRB2-11A02 MRB2-11A02											
Hilfskontaktmodul MU 2 Öffner					H216 H220 H226 H233 B240 B250 B263	MUH2-02A01 MUH2-02A01 MUH2-02A01 MUH2-02A01 MUB2-02A01 MUB2-02A01 MUB2-02A01	MUH2-02A02 MUH2-02A02 MUH2-02A02 MUH2-02A02 MUB2-02A02 MUB2-02A02 MUB2-02A02								
Klemmpunktmodul MX 4 Klemmenstützpunkte 2,5 mm ²								H216 H220 H226 H233 B240 B250 B263 H406 H408 H410 H412	— — — — — — — — — —	MXH2-04A02 MXH2-04A02 MXH2-04A02 MXH2-04A02 MXH4-04A02 MXH4-04A02 MXH4-04A02 MXH4-04A02 MXH4-04A02 MXH4-04A02 MXH4-04A02					
Verbindungsbrücke neutral zur Verbindung der Neutralleiter- module MA beim Umschalter 71400											H200 B200 H400	224234 224301 404111	224234 224303 404111		

Zusatzschilder/Achsverlängerungen

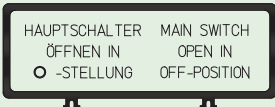

Beispiel: FAZ2-8041

Zusatzschilder

mit Zusatzbeschriftung zum nachträglichen Aufstecken auf Frontschilder und Vorhängeschlossperren

Bestellnummer

- Schildrahmen schwarz, Schrifteinlage silber, unbeschriftet (gravierbar) **FAZ2 - 8000**
- Schildrahmen schwarz, Schrifteinlage silber, Beschriftung schwarz, Beschriftung s. "Aufschriften für Zusatzschilder" **FAZ2 - 8...**
- Schildrahmen schwarz, Schrifteinlage silber, Beschriftung schwarz, Sonderbeschriftung **FAZ2 - (Sonder-Nr.)**
- Schildrahmen schwarz, Schrifteinlage gelb, unbeschriftet (gravierbar) **FBZ2 - 8000**
- Schildrahmen schwarz, Schrifteinlage gelb, Beschriftung schwarz, Beschriftung s. "Aufschriften für Zusatzschilder" **FBZ2 - 8...**
- Schildrahmen schwarz, Schrifteinlage gelb, Beschriftung schwarz, Sonderbeschriftung **FBZ2 - (Sonder-Nr.)**
- Schildrahmen schwarz (ohne Schrifteinlage) **FAZ2**

Schrifteinlagen für Zusatzschilder

- Schrifteinlage silber unbeschriftet (gravierbar) **FAS2 - 8000**
- Schrifteinlage silber, Beschriftung schwarz, Beschriftung s. "Aufschriften für Zusatzschilder" **FAS2 - 8...**
- Schrifteinlage silber, Beschriftung schwarz, Sonderbeschriftung **FAS2 - (Sonder-Nr.)**
- Schrifteinlage gelb, unbeschriftet (gravierbar) **FBS2 - 8000**
- Schrifteinlage gelb, Beschriftung schwarz, Beschriftung s. "Aufschriften für Zusatzschilder" **FBS2 - 8...**
- Schrifteinlage gelb, Beschriftung schwarz, Sonderbeschriftung **FBS2 - (Sonder-Nr.)**

Aufschriften für Zusatzschilder

FA 8000	FA 8001	FA 8002	FA 8003	FA 8013	FA 8026	FA 8027
FA 8028	FA 8029	FA 8030	FA 8031	FA 8037	FA 8039	FA 8040
FA 8041	FA 8044	FA 8045	FA 8046	FA 8047		

Modularachsverlängerungen für Bauformen mit Türverriegelung (bitte getrennt bestellen!)

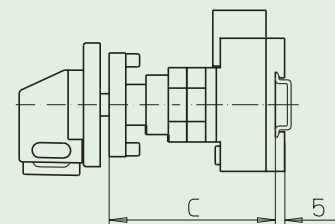
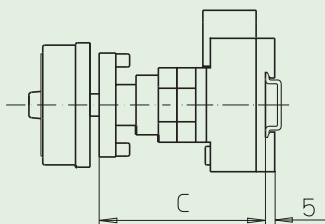
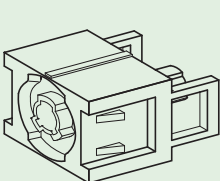

H216/H220/H226/H233 B240/B250/B263	H216/H220/H226/H233 B240/B250/B263	H406/H408/H410/H412	H406/H408/H410/H412	Bestellnummer
3...4-polige Haupt-/Notausschalter 3...4-polige Hauptschalter 3...4-polige Ein-/Ausschalter	6...8-polige Haupt-/Notausschalter 6...8-polige Hauptschalter 6...8-polige Ein-/Ausschalter 3...4-polige Umschalter	3...4-polige Haupt-/Notausschalter 3...4-polige Hauptschalter 3...4-polige Ein-/Ausschalter	6...8-polige Haupt-/Notausschalter 6...8-polige Hauptschalter 6...8-polige Ein-/Ausschalter 3...4-polige Umschalter	H216 B240 H406 H220 B250 H408 H226 B263 H410 H233 H412

Abmessung C (Einbaumaß: Innenseite Tür bis Oberkante Tragschiene):

092 ... 107 mm	100 ... 115 mm	103 ... 117 mm	116 ... 130 mm	-	-
114 ... 132 mm	122 ... 140 mm	124 ... 142 mm	137 ... 155 mm	AVC2-1	AVC4-1
139 ... 157 mm	147 ... 165 mm	149 ... 167 mm	162 ... 180 mm	AVC2-2	AVC4-2
164 ... 182 mm	172 ... 190 mm	174 ... 192 mm	187 ... 205 mm	AVC2-3	AVC4-3
189 ... 207 mm	197 ... 215 mm	199 ... 217 mm	212 ... 230 mm	AVC2-4	AVC4-4

Lasttrennschalter

Technische Informationen Zubehör

Metallachsen

Metallachsen für Bauformen mit Türverriegelung (bitte getrennt bestellen!)

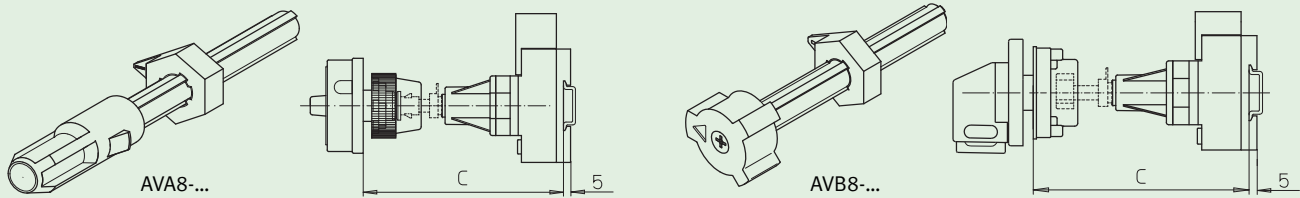

H216/H220/H226/H233 B240/B250/B263	B240/B250/B263	H216/H220/H226/H233	H406/H408/H410/H412	H406/H408/H410/H412	Bestellnummer
3...4-pol. Haupt-/Notausschalter 3...4-polige Hauptschalter 3...4-polige Ein-/Ausschalter	6...8-pol. Haupt-/Notausschalter 6...8-polige Hauptschalter 6...8-polige Ein-/Ausschalter 3...4-polige Umschalter	6...8-pol. Haupt-/Notausschalter 6...8-polige Hauptschalter 6...8-polige Ein-/Ausschalter 3...4-polige Umschalter	3...4-pol. Haupt-/Notausschalter 3...4-polige Hauptschalter 3...4-polige Ein-/Ausschalter	6...8-pol. Haupt-/Notausschalter 6...8-polige Hauptschalter 6...8-polige Ein-/Ausschalter 3...4-polige Umschalter	

Zentralbefestigung frontseitig

Abmessung C (Einbaumaß: Außenseite Tür bis Oberkante Tragschiene):

155 ... 173 mm	163 ... 183 mm	167 ... 185 mm	165 ... 183 mm	177 ... 195 mm	AVA8 - 065
174 ... 198 mm	182 ... 206 mm	186 ... 210 mm	184 ... 208 mm	196 ... 220 mm	AVA8 - 090
199 ... 223 mm	207 ... 231 mm	211 ... 235 mm	209 ... 233 mm	221 ... 245 mm	AVA8 - 115
224 ... 248 mm	232 ... 256 mm	236 ... 260 mm	234 ... 258 mm	246 ... 270 mm	AVA8 - 140
249 ... 273 mm	257 ... 281 mm	261 ... 285 mm	259 ... 283 mm	271 ... 295 mm	AVA8 - 165
274 ... 298 mm	282 ... 306 mm	286 ... 310 mm	284 ... 308 mm	296 ... 320 mm	AVA8 - 190
299 ... 323 mm	307 ... 331 mm	311 ... 335 mm	309 ... 333 mm	321 ... 345 mm	AVA8 - 215
324 ... 348 mm	332 ... 356 mm	336 ... 360 mm	334 ... 358 mm	346 ... 370 mm	AVA8 - 240
349 ... 373 mm	357 ... 381 mm	361 ... 385 mm	359 ... 383 mm	371 ... 395 mm	AVA8 - 265
374 ... 398 mm	382 ... 406 mm	386 ... 410 mm	384 ... 408 mm	396 ... 420 mm	AVA8 - 290
399 ... 423 mm	407 ... 431 mm	411 ... 435 mm	409 ... 433 mm	421 ... 445 mm	AVA8 - 315
424 ... 448 mm	432 ... 456 mm	436 ... 460 mm	434 ... 458 mm	446 ... 470 mm	AVA8 - 340
449 ... 473 mm	457 ... 481 mm	461 ... 485 mm	459 ... 483 mm	471 ... 495 mm	AVA8 - 365
474 ... 498 mm	482 ... 506 mm	486 ... 510 mm	484 ... 508 mm	496 ... 520 mm	AVA8 - 390
499 ... 523 mm	507 ... 531 mm	511 ... 535 mm	509 ... 533 mm	521 ... 545 mm	AVA8 - 415
524 ... 548 mm	532 ... 556 mm	536 ... 560 mm	534 ... 558 mm	546 ... 570 mm	AVA8 - 440
549 ... 573 mm	557 ... 581 mm	561 ... 585 mm	559 ... 583 mm	571 ... 595 mm	AVA8 - 465
574 ... 598 mm	582 ... 606 mm	586 ... 610 mm	584 ... 608 mm	596 ... 620 mm	AVA8 - 490
599 ... 623 mm	607 ... 631 mm	611 ... 635 mm	609 ... 633 mm	621 ... 645 mm	AVA8 - 515
624 ... 643 mm	632 ... 656 mm	636 ... 660 mm	634 ... 658 mm	646 ... 670 mm	AVA8 - 540

Vierlochbefestigung frontseitig

Abmessung C (Einbaumaß: Innenseite Tür bis Oberkante Tragschiene):

140 ... 164 mm	148 ... 172 mm	152 ... 176 mm	150 ... 174 mm	162 ... 186 mm	AVB8 - 065
165 ... 189 mm	173 ... 197 mm	177 ... 201 mm	175 ... 199 mm	187 ... 211 mm	AVB8 - 090
190 ... 214 mm	198 ... 222 mm	202 ... 226 mm	200 ... 224 mm	212 ... 236 mm	AVB8 - 115
215 ... 239 mm	223 ... 247 mm	227 ... 251 mm	225 ... 249 mm	237 ... 261 mm	AVB8 - 140
240 ... 264 mm	248 ... 272 mm	252 ... 276 mm	250 ... 274 mm	262 ... 286 mm	AVB8 - 165
265 ... 289 mm	276 ... 297 mm	277 ... 301 mm	275 ... 299 mm	287 ... 311 mm	AVB8 - 190
290 ... 314 mm	298 ... 322 mm	300 ... 326 mm	300 ... 324 mm	312 ... 336 mm	AVB8 - 215
315 ... 339 mm	323 ... 347 mm	327 ... 351 mm	325 ... 349 mm	337 ... 361 mm	AVB8 - 240
340 ... 364 mm	348 ... 372 mm	352 ... 376 mm	350 ... 374 mm	362 ... 386 mm	AVB8 - 265
365 ... 389 mm	373 ... 397 mm	377 ... 401 mm	375 ... 399 mm	387 ... 411 mm	AVB8 - 290
390 ... 414 mm	398 ... 422 mm	402 ... 426 mm	400 ... 424 mm	412 ... 436 mm	AVB8 - 315
415 ... 439 mm	423 ... 447 mm	427 ... 451 mm	425 ... 449 mm	437 ... 461 mm	AVB8 - 340
440 ... 464 mm	448 ... 472 mm	452 ... 476 mm	450 ... 474 mm	462 ... 486 mm	AVB8 - 365
465 ... 489 mm	473 ... 497 mm	477 ... 501 mm	475 ... 499 mm	487 ... 511 mm	AVB8 - 390
490 ... 514 mm	498 ... 522 mm	502 ... 526 mm	500 ... 524 mm	512 ... 536 mm	AVB8 - 415
515 ... 539 mm	523 ... 547 mm	527 ... 551 mm	525 ... 549 mm	537 ... 561 mm	AVB8 - 440
540 ... 564 mm	548 ... 572 mm	552 ... 576 mm	550 ... 574 mm	562 ... 586 mm	AVB8 - 465
565 ... 589 mm	573 ... 597 mm	577 ... 601 mm	575 ... 599 mm	587 ... 611 mm	AVB8 - 490
590 ... 614 mm	598 ... 622 mm	602 ... 626 mm	600 ... 624 mm	612 ... 636 mm	AVB8 - 515
615 ... 639 mm	625 ... 649 mm	627 ... 651 mm	625 ... 649 mm	637 ... 661 mm	AVB8 - 540

Klemmenabdeckungen

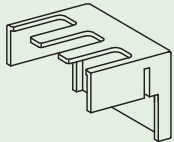

TCA/TCC

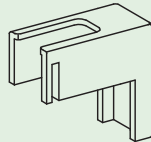

TCB/TCB

Klemmenabdeckungen sind verwendbar für Fronteinbau und Bodeneinbau. Bei der Produktreihe H400 gehören Klemmenabdeckungen zum Lieferumfang der Bauformen für Hauptschalter und Haupt-/Notausschalter und müssen nicht separat bestellt werden.

Bedingt durch das Schaltprogramm werden unterschiedliche Klemmenabdeckungen benötigt. Bitte geben Sie bei Ihrer Bestellung die entsprechende Stückzahl an!

H216/H220/H226/H233

Schaltprogramme	Stück	Bestellnummer	Stück	Bestellnummer
41200, 41211, 41220, 41222, 41231, 41240	1	TCA2	–	–
41300, 41311, 41320, 41322, 41331, 41340	1	TCA2	–	–
41400, 41411, 41420	1	TCA2	1	TCB2
41600, 41611, 41620, 41622, 41631, 41640	2	TCA2	–	–
41800	2	TCA2	2	TCB2
42400, 42411, 42420	1	TCA2	1	TCB2
42500	1	TCA2	2	TCB2
42700, 42711, 42720	2	TCA2	1	TCB2
42800	2	TCA2	2	TCB2
45300, 45311, 45320, 46300, 46311, 46320	1	TCA2	–	–
47200, 47211, 47220, 47300, 47311, 47320	1	TCA2	–	–
47400, 48400	1	TCA2	1	TCB2

B240/B250/B263

für Anschlussquerschnitt bis max. 16 mm²

Schaltprogramme	Stück	Bestellnummer	Stück	Bestellnummer
41200, 41211, 41220, 41222, 41231, 41240	1	TCC2	–	–
41300, 41311, 41320, 41322, 41331, 41340	1	TCC2	–	–
41400, 41411, 41420	1	TCC2	1	TCB2
41600, 41611, 41620, 41622, 41631, 41640	2	TCC2	–	–
41800	2	TCC2	2	TCB2
42400, 42411, 42420	1	TCC2	1	TCB2
42500	1	TCC2	2	TCB2
42700, 42711, 42720	2	TCC2	1	TCB2
42800	2	TCC2	2	TCB2
45300, 45311, 45320, 46300, 46311, 46320	1	TCC2	–	–
47200, 47211, 47220, 47300, 47311, 47320	1	TCC2	–	–
47400, 48400	1	TCC2	1	TCB2

H406/H408/H410/H412

Schaltprogramme	Stück	Bestellnummer	Stück	Bestellnummer
41200, 41211, 41220, 41222, 41231, 41240	1	TCA4	–	–
41300, 41311, 41320, 41322, 41331, 41340	1	TCA4	–	–
41400, 41411, 41420	1	TCA4	1	TCB4
41600, 41611, 41620, 41622, 41631, 41640	2	TCA4	–	–
41800	2	TCA4	2	TCB4
42400, 42411, 42420	1	TCA4	1	TCB4
42500	1	TCA4	2	TCB4
42700, 42711, 42720	2	TCA4	1	TCB4
42800	2	TCA4	2	TCB4
45300, 45311, 45320, 46300, 46311, 46320	1	TCA4	–	–
47200, 47211, 47220, 47300, 47311, 47320	1	TCA4	–	–
47400, 48400	1	TCA4	1	TCB4

Lasttrennschalter

Technische Informationen **Zubehör**

Montageschlüssel/Befestigungslaschen

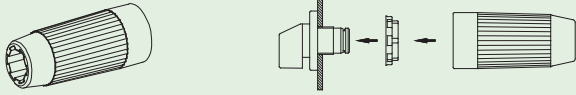

218098

Montageschlüssel für Zentralbefestigung

geeignet zur schnellen Montage von Frontschildern und Vorhängeschlosssperrern in Zentralbefestigung

Typen	Bestellnummer
H216, H220, H226, H233, B240, B250, B263	218098

Befestigungslaschen zur Außenbefestigung der Gehäuse (1 Satz)

M6 x 16



Befestigungslasche

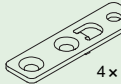

4 x

4 x

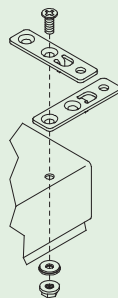

4 x



4 x

Gehäuse	Abmessungen	Bestellnummer
Stahlgehäuse	150 x 150 x 120 mm	SAX1
Stahlgehäuse	200 x 150 x 120 mm	SAX1
Stahlgehäuse	300 x 250 x 120 mm	SAX1
Edelstahlgehäuse	150 x 150 x 120 mm	SBX1
Edelstahlgehäuse	200 x 150 x 120 mm	SBX1
Edelstahlgehäuse	300 x 250 x 120 mm	SBX1





Antriebsvarianten für Bauformen mit Vorhängeschlossperre

Antrieb Verwendbar für Typen		Farbe Frontschild	Farbe Schrifteinlage	Farbe Antrieb	Bestellnummer- änderung
N-Vorhängeschlossperre H216, H220, H226, H233 B240, B250, B263 H406, H408, H410, H412 K616		schwarz	weiß	schwarz	... - - ...N1
		grau	weiß	grau	... - - ...N2
		gelb	weiß	rot	... - - ...N4
		grau	weiß	schwarz	... - - ...N6
		gelb	weiß	schwarz	... - - ...N7
		Außenabmessung Antrieb 67 x 67 mm 88 x 88 mm	max. Anzahl Vorhängeschlösser 3 4	Bügeldurchmesser Schloss 4 mm (min) / 8 mm (max) 5 mm (min) / 9 mm (max)	
M-Vorhängeschlossperre H216, H220, H226, H233 B240, B250, B263 H406, H408, H410, H412 K616		schwarz	weiß	schwarz	... - - ...M1
		grau	weiß	grau	... - - ...M2
		gelb	weiß	rot	... - - ...M4
		grau	weiß	schwarz	... - - ...M6
		gelb	weiß	schwarz	... - - ...M7
		Außenabmessung Antrieb 48 x 48 mm 67 x 67 mm 88 x 88 mm	max. Anzahl Vorhängeschlösser 3 3 4	Bügeldurchmesser Schloss 3 mm (min) / 5 mm (max) 4 mm (min) / 8 mm (max) 5 mm (min) / 9 mm (max)	
B-Vorhängeschlossperre H406, H408, H410, H412 K616 K830		schwarz	silber	schwarz	... - - ...B1
		schwarz	gelb	rot	... - - ...B4
		schwarz	schwarz	schwarz	... - - ...B8
		Außenabmessung Antrieb 75 x 114 mm 98 x 142 mm 130 x 178 mm	max. Anzahl Vorhängeschlösser 4 4 4	Bügeldurchmesser Schloss 5 mm (min) / 8 mm (max) 5 mm (min) / 8 mm (max) 5 mm (min) / 8 mm (max)	
H-Vorhängeschlossperre H406, H408, H410, H412 K616 K830		schwarz	silber	schwarz	... - - ...H1
		schwarz	gelb	rot	... - - ...H4
		schwarz	schwarz	schwarz	... - - ...H8
		Außenabmessung Antrieb 75 x 114 mm 98 x 142 mm 130 x 178 mm	max. Anzahl Vorhängeschlösser 4 4 4	Bügeldurchmesser Schloss 5 mm (min) / 8 mm (max) 5 mm (min) / 8 mm (max) 5 mm (min) / 8 mm (max)	
Griffverriegelung mit V-Griff H216, H220, H226, H233 B240, B250, B263 H406, H408, H410, H412		schwarz	silber	schwarz	... - - ...V1
		schwarz	gelb	rot	... - - ...V4
		Außenabmessung Antrieb 48 x 48 mm 64 x 64 mm	max. Anzahl Vorhängeschlösser 2 3	Bügeldurchmesser Schloss 3 mm (min) / 5 mm (max) 4 mm (min) / 6 mm (max)	
Verteilereinbau mit Frontschild für 45 mm Normausschnitt:					
Griffverriegelung mit V-Griff (Frontschild bedruckt) H216, H220, H226, H233 B240, B250, B263 H406, H408, H410, H412		grau	silber	schwarz	... - - ...V1
		grau	gelb	rot	... - - ...V4
		Verriegelungsgriff Größe 2	max. Anzahl Vorhängeschlösser 2	Bügeldurchmesser Schloss 3 mm (min) / 5 mm (max)	
Griffverriegelung mit V-Griff (Frontschild bedruckt) H406, H408, H410, H412		grau	–	schwarz	... - - ...V1
		gelb	–	rot	... - - ...V4
		Verriegelungsgriff Größe 4	max. Anzahl Vorhängeschlösser 3	Bügeldurchmesser Schloss 4 mm (min) / 6 mm (max)	

Lasttrennschalter

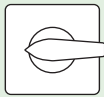
Technische Informationen Antriebe

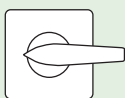
Antriebsvarianten für Bauformen mit Frontschild und Griff

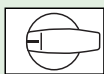
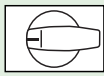
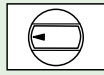
Antrieb Verwendbar für Typen		Farbe Frontschild	Farbe Schrifteinlage	Farbe Antrieb	Bestellnummer- änderung
M-Griff H216, H220, H226, H233 B240, B250, B263 H406, H408, H410, H412 K616		schwarz grau weiß schwarz schwarz schwarz	silber silber silber gelb silber schwarz	schwarz grau weiß rot rot schwarz - - ...M1 - - ...M2 - - ...M3 - - ...M4 - - ...M5 - - ...M8
F-Griff H216, H220, H226, H233 B240, B250, B263 H406, H408, H410, H412 K616		schwarz grau weiß schwarz schwarz schwarz	silber silber silber gelb silber schwarz	schwarz grau weiß rot rot schwarz - - ...F1 - - ...F2 - - ...F3 - - ...F4 - - ...F5 - - ...F8
B-Griff H216, H220, H226, H233 B240, B250, B263 H406, H408, H410, H412 K616		schwarz grau weiß schwarz schwarz schwarz	silber silber silber gelb silber schwarz	schwarz grau weiß rot rot schwarz - - ...B1 - - ...B2 - - ...B3 - - ...B4 - - ...B5 - - ...B8
N-Griff H216, H220, H226, H233 B240, B250, B263		schwarz grau weiß schwarz schwarz schwarz	silber silber silber gelb silber schwarz	schwarz grau weiß rot rot schwarz - - ...N1 - - ...N2 - - ...N3 - - ...N4 - - ...N5 - - ...N8
G-Griff H406, H408, H410, H412 K616 K830		schwarz schwarz schwarz schwarz	silber gelb silber schwarz	schwarz rot rot schwarz - - ...G1 - - ...G4 - - ...G5 - - ...G8
R-Griff H216, H220, H226, H233 B240, B250, B263		schwarz grau weiß schwarz schwarz	silber silber silber gelb silber	schwarz grau weiß rot rot - - ...R1 - - ...R2 - - ...R3 - - ...R4 - - ...R5
Verteilereinbau mit Frontschild für 45 mm Normausschnitt:					
M-Griff H216, H220, H226, H233 B240, B250, B263 H406, H408, H410, H412		grau grau grau	silber silber gelb	schwarz grau rot - - ...M1 - - ...M2 - - ...M4
M-Griff (Frontschild bedruckt) H406, H408, H410, H412		grau grau gelb	– – –	schwarz grau rot - - ...M1 - - ...M2 - - ...M4
N-Griff H216, H220, H226, H233 B240, B250, B263		grau grau grau	silber silber gelb	schwarz grau rot - - ...N1 - - ...N2 - - ...N4

Gebrauchskategorien

Gebrauchskategorien für Lastschalter, Trennschalter, Lasttrennschalter und Schalter-Sicherungs-Einheiten entsprechend IEC/EN 60947-3

Stromart	Gebrauchskategorie		Typische Anwendungsfälle
	Häufige Betätigung	Gelegentliche Betätigung	
Wechselstrom	AC-15A	AC-15B	Steuern elektromagnetischer Last
	AC-20A *	AC-20B *	Schließen und Öffnen ohne Last
	AC-21A	AC-21B	Schalten von ohmscher Last einschließlich geringer Überlast
	AC-22A	AC-22B	Schalten von gemischter ohmscher und induktiver Last einschließlich geringer Überlast
	AC-23A	AC-23B	Schalten von Motoren oder anderer hochinduktiver Last
Gleichstrom	DC-20A *	DC-20B *	Schließen und Öffnen ohne Last
	DC-21A	DC-21B	Schalten von ohmscher Last einschließlich geringer Überlast
	DC-22A	DC-22B	Schalten von gemischter ohmscher und induktiver Last einschließlich geringer Überlast (z. B. Nebenschlussmotoren)
	DC-23A	DC-23B	Schalten von hochinduktiver Last (z. B. Reihenschlussmotoren)

* Die Anwendung dieser Gebrauchskategorien ist in den USA nicht erlaubt.

Die Gebrauchskategorie AC-23 schließt gelegentliches Schalten einzelner Motoren ein. Die Gebrauchskategorien der obigen Tabelle gelten nicht für ein Gerät, das betriebsmäßig zum Ingangsetzen, Beschleunigen und/oder zum Ausschalten einzelner Motoren verwendet wird. Für ein derartiges Schaltgerät gelten die Gebrauchskategorien der folgenden Tabelle:

Stromart	Gebrauchskategorie	Typische Anwendungsfälle
Wechselstrom	AC-2	Schleifringläufermotoren: Anlassen, Gegenstrombremsen oder Reversieren ¹⁾ , Ausschalten
	AC-3	Käfigläufermotoren: Anlassen, Ausschalten während des Laufes
	AC-4	Käfigläufermotoren: Anlassen, Gegenstrombremsen oder Reversieren ¹⁾ , Tippen ²⁾
Gleichstrom	DC-3	Nebenschlussmotoren: Anlassen, Gegenstrombremsen oder Reversieren ¹⁾ , Tippen ²⁾ , Widerstandsbremsen von Gleichstrommotoren
	DC-4	Reihenschlussmotoren: Anlassen, Gegenstrombremsen oder Reversieren ¹⁾ , Tippen ²⁾ , Widerstandsbremsen von Gleichstrommotoren

¹⁾ Gegenstrombremsen oder Reversieren ist das schnelle Bremsen oder Umkehren der Drehrichtung eines Motors durch Vertauschen der Motoranschlussleitung während des Motorlaufs.

²⁾ Tippen ist das einmalige oder wiederholte kurzzeitige Einschalten eines Motors, um kleine Bewegungen der angetriebenen Maschine zu erhalten.

Anmerkung: Das Schalten von Läuferstromkreisen, Kondensatoren, Glüh- und Gasentladungslampen muss zwischen Hersteller und Anwender gesondert vereinbart werden.

Lasttrennschalter

Technische Informationen Motorbemessungsströme

Motorbemessungsströme von Drehstrommotoren (Richtwerte für Käfigläufer)

Motorleistung			Motorbemes- sungsstrom A	Sicherung bei Anlauf		Motorbemes- sungsstrom A	Sicherung bei Anlauf	
kW	cos φ	Wirkungsgrad η %		direkt A	Y/Δ A		direkt A	Y/Δ A
			230 V			400 V		
0,06	0,7	58	0,37	2	—	0,21	2	—
0,09	0,7	60	0,54	2	—	0,31	2	—
0,12	0,7	60	0,72	4	2	0,41	2	—
0,18	0,7	62	1,04	4	2	0,6	2	—
0,25	0,7	62	1,4	4	2	0,8	4	2
0,37	0,72	66	2	6	4	1,1	4	2
0,55	0,75	69	2,7	10	4	1,5	4	2
0,75	0,79	74	3,2	10	4	1,9	6	4
1,1	0,81	74	4,6	10	6	2,6	6	4
1,5	0,81	74	6,3	16	10	3,6	6	4
2,2	0,81	78	8,7	20	10	5	10	6
3	0,82	80	11,5	25	16	6,6	16	10
4	0,82	83	14,8	32	16	8,5	20	10
5,5	0,82	86	19,6	32	25	11,3	25	16
7,5	0,82	87	26,4	50	32	15,2	32	16
11	0,84	87	38	80	40	21,7	40	25
15	0,84	88	51	100	63	29,3	63	32
18,5	0,84	88	63	125	80	36	63	40
22	0,84	92	71	125	80	41	80	50
30	0,85	92	96	200	100	55	100	63
37	0,86	92	117	200	125	68	125	80
45	0,86	93	141	250	160	81	160	100
55	0,86	93	173	250	200	99	200	125
75	0,86	94	233	315	250	134	200	160
90	0,86	94	279	400	315	161	250	200
110	0,86	94	342	500	400	196	315	200
132	0,87	95	401	630	500	231	400	250
160	0,87	95	486	630	630	279	400	315
200	0,87	95	607	800	630	349	500	400
250	0,87	95	—	—	—	437	630	500
315	0,87	96	—	—	—	544	800	630
400	0,88	96	—	—	—	683	1000	800
			500 V			690 V		
0,06	0,7	58	0,17	2	—	0,12	2	—
0,09	0,7	60	0,25	2	—	0,18	2	—
0,12	0,7	60	0,33	2	—	0,24	2	—
0,18	0,7	62	0,48	2	—	0,35	2	—
0,25	0,7	62	0,7	2	—	0,5	2	—
0,37	0,72	66	0,9	2	2	0,7	2	—
0,55	0,75	69	1,2	4	2	0,9	4	2
0,75	0,79	74	1,5	4	2	1,1	4	2
1,1	0,81	74	2,1	6	4	1,5	4	2
1,5	0,81	74	2,9	6	4	2,1	6	4
2,2	0,81	78	4	10	4	2,9	10	4
3	0,82	80	5,3	16	6	3,8	10	4
4	0,82	83	6,8	16	10	4,9	16	6
5,5	0,82	86	9	20	16	6,5	16	10
7,5	0,82	87	12,1	25	16	8,8	25	10
11	0,84	87	17,4	32	20	12,6	25	16
15	0,84	88	23,4	50	25	17	32	20
18,5	0,84	88	28,9	50	32	20,9	32	25
22	0,84	92	33	63	32	23,8	50	25
30	0,85	92	44	80	50	32	63	32
37	0,86	92	54	100	63	39	80	50
45	0,86	93	65	125	80	47	80	63
55	0,86	93	79	160	80	58	100	63
75	0,86	94	107	200	125	78	160	100
90	0,86	94	129	200	160	93	160	100
110	0,86	94	157	250	160	114	200	125
132	0,87	95	184	250	200	134	250	160
160	0,87	95	224	315	250	162	250	200
200	0,87	95	279	400	315	202	315	250
250	0,87	95	349	500	400	253	400	315
315	0,87	96	436	630	500	316	500	400
400	0,88	96	547	800	630	396	630	400

Die Motorbemessungsströme gelten für normale innen- und oberflächengekühlte Drehstrommotoren mit 1500 min⁻¹/50 Hz.
 Sicherung: träge bzw. gL-Charakteristik (DIN VDE 0636), mit Angabe der kleinstmöglichen Kurzschluss-Sicherung
 Anlauf direkt: Anlaufzeit max. 5 s, Anlaufstrom max. 6 × Motorbemessungsstrom
 Anlauf Y/Δ: Anlaufzeit max. 15 s, Anlaufstrom max. 2 × Motorbemessungsstrom

IP-Codes

Schutzarten entsprechend IEC/EN 60529 definieren den Schutz elektrischer Betriebsmittel in Gehäusen etc. und werden durch einen IP-Code gekennzeichnet, der aus den Buchstaben „IP“ und zwei Kennzahlen besteht. Die 1. Kennzahl definiert den Schutz gegen das Eindringen fester Körper sowie den Berührungsschutz der unter Spannung stehenden Teile. Die 2. Kennzahl definiert den Schutz gegen schädliches Eindringen von Wasser. Die Bedingungen für Schutzart IP68 sind zwischen Hersteller und Anwender zu vereinbaren.

IP 6 6

Kennzahl für die Schutzart gegen das Eindringen fester Körper und das Berühren unter Spannung stehender Teile.

Kennzahl für die Schutzart gegen schädliches Eindringen von Wasser.

1. Kennzahl **Schutz gegen das Eindringen fester Körper und das Berühren unter Spannung stehender Teile**

2. Kennzahl **Schutz gegen schädliches Eindringen von Wasser**

0

Kein Schutz.

0

Kein Schutz.

1



Kein Eindringen fester Körper mit einem Durchmesser von ≥ 50 mm. Schutz gegen das Berühren unter Spannung stehender Teile mit dem Handrücken.

1



Senkrecht fallendes Tropfwasser darf keine schädliche Wirkung haben.

2

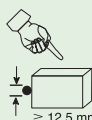

Kein Eindringen fester Körper mit einem Durchmesser von $\geq 12,5$ mm. Schutz gegen das Berühren unter Spannung stehender Teile mit dem Finger.

2



Senkrecht fallendes Tropfwasser darf keine schädliche Wirkung haben, wenn das Gehäuse bis 15° geneigt ist.

3

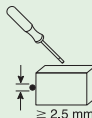

Kein Eindringen fester Körper mit einem Durchmesser von $\geq 2,5$ mm. Schutz gegen das Berühren unter Spannung stehender Teile mit einem Werkzeug.

3

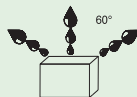

Spritzwasser bis zu 60° zur Vertikalen darf keine schädliche Wirkung haben.

4

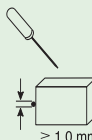

Kein Eindringen fester Körper mit einem Durchmesser von ≥ 1 mm. Schutz gegen das Berühren unter Spannung stehender Teile mit einem Draht.

4

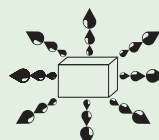

Spritzwasser aus allen Richtungen darf keine schädliche Wirkung haben.

5

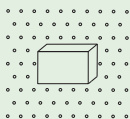

Schutz gegen schädliche Staubablagerungen. Vollständiger Schutz gegen das Berühren unter Spannung stehender Teile.

5

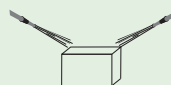

Ein Düsenstrahl aus allen Richtungen darf keine schädliche Wirkung haben.

6

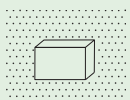

Schutz gegen das Eindringen von Staub. Vollständiger Schutz gegen das Berühren unter Spannung stehender Teile.

6

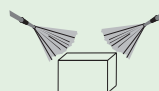

Ein starker Düsenstrahl aus allen Richtungen darf keine schädliche Wirkung haben.

1B

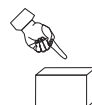

Ein Testfinger darf bei einer maximalen Eindringung von 80 mm aus der Einbaurichtung keine unter Spannung stehenden Teile berühren.

7

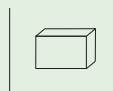

Zeitweiliges Eintauchen in Wasser darf keine schädliche Wirkung haben.

8

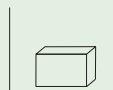

Dauerndes Eintauchen in Wasser darf keine schädliche Wirkung haben.

Lasttrennschalter

Technische Informationen Technische Daten

Bemessungsdaten

Strombahnen			H216	H220	H226	H233	B240	B250	B263	H406	H408	H410	H412	K616	K830
Betriebsspannung U_e	(V AC)		690	690	690	690	690	690	690	690 ¹	690 ¹	690 ¹	690 ¹	690	690
Stoßspannungsfestigkeit U_{imp}	(kV)		6	6	6	6	6	6	6	8	8	8	8	6	6
Überspannungskategorie			III	III	III	III	III	III	III	III	III	III	III	III	III
Verschmutzungsgrad			3	3	3	3	3	3	3	3	3	3	3	3	3
Dauerstrom $I_u / I_{th} / I_{the}$	(A)		20	25	32	40	40	50	63	63	80	100	125	160	315
Belastbarkeit bei Aussetzbetrieb (Klasse 12)	(AB)	Einschaltdauer: 60% = $1,3 \times I_e$ / 40% = $1,6 \times I_e$ / 25% = $2 \times I_e$													
Ausschaltvermögen	220–240V	(A)	150	250	300	330	340	340	340	500	550	600	800	900	1800
	380–440V	(A)	150	250	300	330	340	340	340	500	550	600	750	850	1650
	500–690V	(A)	100	150	190	220	200	200	200	270	285	300	320	340	350
Kurzschlussfestigkeit (max. Vorsicherung)	(gL)		20	25	35	40	40	50	63	63	80	100	125	160	315
Bedingter Kurzschlussstrom	(kA _{eff})		15	15	15	15	—	—	—	25	25	25	25	25	25
Kurzschlusseinschaltvermögen I_{cm}	(kA)		—	—	—	—	1,4	1,6	1,8	—	—	—	—	—	—
Kurzzeitstromfestigkeit (1 s)	(A)		—	—	—	—	500	600	750	—	—	—	—	—	—
Trenneigenschaften (nach EN 60947)	(bis ... V AC)		690	690	690	690	690	690	690	1000	1000	1000	1000	690	690
Schaltwinkel			90°	90°	90°	90°	90°	90°	90°	90°	90°	90°	90°	90°	90°
Strombahnen (max.)			8	8	8	8	8	8	8	8	8	8	8	8	8
Stromwärmeverlust pro Strombahn bei I_u	(W)		0,8	0,8	1,8	2,1	2,0	2,4	3,0	3,0	4,1	5,5	6,9	11	28,5
Max. Anschlussquerschnitt (Ein-/Ausschalter)															
ein- bzw. mehrdrätig	min.	(mm ²)	1	1	1	1	6	6	6	4	4	4	4	95 ²	185 ²
	max.	(mm ²)	10	10	10	10	25	25	25	50	50	50	50	95 ²	185 ²
fein- bzw. vieldrätig (mit Aderendhülse)	min.	(mm ²)	0,75	0,75	0,75	0,75	4	4	4	2,5	2,5	2,5	2,5	95 ²	185 ²
	max.	(mm ²)	6	6	6	6	16	16	16	35	35	35	35	95 ²	185 ²
American Wire Gauge (Ein-/Ausschalter)	(AWG)		8	8	8	8	4	4	4	1/0	1/0	1/0	1/0	4/0	350MCM
Max. Anschlussquerschnitt (Umschalter mit Verbindungsbrücke)															
ein- bzw. mehrdrätig	min.	(mm ²)	1	1	1	1	6	6	6	4	4	4	4	95 ²	185 ²
	max.	(mm ²)	6	6	6	6	16	16	16	35	35	35	35	95 ²	185 ²
fein- bzw. vieldrätig (mit Aderendhülse)	min.	(mm ²)	0,75	0,75	0,75	0,75	4	4	4	2,5	2,5	2,5	2,5	95 ²	185 ²
	max.	(mm ²)	4	4	4	4	10	10	10	25	25	25	25	95 ²	185 ²
American Wire Gauge (Umschalter mit Verbindungsbrücke)	(AWG)		10	10	10	10	6	6	6	2	2	2	2	4/0	350MCM
Gewinde Anschlussschraube			M4	M4	M4	M4	M4	M4	M4	M5	M5	M5	M5	M10	M12
Anzugsdrehmoment	min.	(Nm)	1,2	1,2	1,2	1,2	1,2	1,2	1,2	3,0	3,0	3,0	3,0	10	14
	max.	(Nm)	2,5	2,5	2,5	2,5	2,5	2,5	2,5	5,0	5,0	5,0	5,0	20	25
Betriebsstrom I_e															
AC-21A	(A)		20	25	32	40	40	50	63	63	80	100	125	160	315
AC-22A	220–500V	(A)	20	25	32	40	40	50	63	63	80	100	125	160	315
	660–690V	(A)	16	20	32	40	40	50	63	63	80	100	100	125	125
AC-23A (cos ϕ = 0,65)	400V	(A)	12	16	24	32	32	38	47	47	65	80	97	120	285
cUL General Use	300V AC	(A)	20	25	30	40	40	50	60	63	80	100	125	175	240
	600V AC	(A)	20	25	30	40	40	50	60	63	80	100	125	175	240
Betriebsleistung bei 50–60 Hz (3-polig)															
AC-23A	220–240V	(kW)	3	4	5,5	7,5	7,5	11	15	15	18,5	22	30	37	75
	380–440V	(kW)	5,5	7,5	11	15	15	18,5	22	22	30	37	45	75	132
	500V	(kW)	5,5	7,5	11	15	18,5	18,5	22	22	30	37	45	90	132
	660–690V	(kW)	5,5	7,5	11	15	15	18,5	22	22	30	37	37	55	55
AC-3	220–240V	(kW)	2,2	3	4	5,5	7,5	7,5	11	11	15	22	30	22	37
	380–440V	(kW)	3,7	5,5	7,5	11	11	15	18,5	18,5	22	30	37	45	55
	500V	(kW)	3,7	5,5	7,5	11	15	15	18,5	18,5	30	37	45	45	55
	660–690V	(kW)	3,7	5,5	7,5	11	11	15	18,5	18,5	22	30	37	45	55
cUL	110–120V AC	(HP)	1	1,5	2	3	3	5	5	5	7,5	10	15	15	25
	208V AC	(HP)	2	3	5	7,5	—	—	—	—	10	15	—	15	30
	220–240V AC	(HP)	2	3	5	7,5	7,5	10	10	15	20	25	30	15	30
	440–480V AC	(HP)	3	5	10	15	15	20	20	30	30	30	60	40	50
550–600V AC	(HP)	5	5	10	15	15	20	20	30	30	30	50	50	50	

¹ 1000V, AC-20, Schalten ohne Last

² in Ausführung mit Anschlusswinkel für DIN-Kabelschuh

Bemessungsdaten

Hilfsstromschalter		H216	H220	H226	H233	B240	B250	B263	H406	H408	H410	H412	K616	K830
Betriebsspannung U_e	(V AC)	500	500	500	500	500	500	500	500	500	500	500	500	500
Dauerstrom $I_u / I_{th} / I_{the}$	(A)	10	10	10	10	16	16	16	16	16	16	16	20	20
Betriebsstrom I_e														
AC-21A	(A)	10	10	10	10	10	10	10	10	10	10	10	20	20
	110–240V (A)	2,5	2,5	2,5	2,5	6	6	6	6	6	6	6	6	6
AC-15	380–440V (A)	1,5	1,5	1,5	1,5	4	4	4	4	4	4	4	4	4
	500V (A)	1	1	1	1	1,5	1,5	1,5	1,5	1,5	1,5	1,5	2	2
cUL General Use	600V AC (A)	10	10	10	10	10	10	10	10	10	10	10	20	20
Heavy Pilot Duty		A600	A600	A600	A600	A600	A600	A600	A600	A600	A600	A600	A600	A600
Kurzschlussfestigkeit (max. Vorsicherung)	(gL)	10	10	10	10	16	16	16	16	16	16	16	20	20
Bedingter Kurzschlussstrom	(kA_{eff})	3	3	3	3	3	3	3	3	3	3	3	10	10
Max. Anschlussquerschnitt														
fein- bzw. vieldrätig	min. (mm ²)	1	1	1	1	1	1	1	1	1	1	1	1	1
(mit Aderendhülse)	max. (mm ²)	2,5	2,5	2,5	2,5	2,5	2,5	2,5	2,5	2,5	2,5	2,5	2,5	2,5
American Wire Gauge	(AWG)	14	14	14	14	14	14	14	14	14	14	14	12	12

Allgemeine Angaben

Allgemeine Angaben		H216	H220	H226	H233	B240	B250	B263	H406	H408	H410	H412	K616	K830	
Vorschriften		IEC 60947 / EN 60947 / IEC 60204 / UL 508 / CSA 22.2, No. 14 / VDE 0660 Teil 107													
Mechanische Lebensdauer		>10 ⁵	>10 ⁵	>10 ⁵	>10 ⁵	>10 ⁵	>10 ⁵	>10 ⁵	>10 ⁵	>10 ⁵	>10 ⁵	>10 ⁵	>10 ⁵	>10 ⁵	
Max. Anzahl Schaltspiele / h		50	50	50	50	50	50	50	50	50	50	50	50	50	
Klimafestigkeit	konstant	nach DIN IEC 60068-2-78													
(feuchte Wärme)	zyklisch	nach DIN IEC 60068-2-30													
Umgebungstemperatur	offen (°C)	–25 / +50													
(min. / max.)	gekapselt (°C)	–25 / +40													
Einbaulage		beliebig													
Schocksicherheit	(g)	>25	>25	>25	>25	>25	>25	>25	>25	>25	>25	>25	>10	>10	
(Schockdauer 20ms)															
Bemessungsfrequenzbereich	(Hz)	50 bis 60 (andere Frequenzen auf Anfrage)													

Konformität

Sälzer Electric Lasttrennschalter entsprechen den Vorschriften der „Richtlinie 2014/35/EU zur Harmonisierung der Rechtsvorschriften der Mitgliedsstaaten über die Bereitstellung elektrischer Betriebsmittel zur Verwendung innerhalb bestimmter Spannungsgrenzen auf dem Markt“, genannt Niederspannungsrichtlinie.

Die Anforderungen dieser Richtlinie sind für Lasttrennschalter untersetzt mit den harmonisierten Europäischen Normen EN 60947-1, EN 60947-3, EN 60947-5-1, EN 60204-1.

Nach diesen genannten Normen werden alle Produkte von Sälzer entwickelt, produziert und geprüft. Mit der auf allen Schaltern angebrachten CE-Kennzeichnung wird die Richtlinienkonformität bestätigt.

Lasttrennschalter von Sälzer sind nach UL 60947 approbiert. Die Lasttrennschalter H216, H220, B240, B250, B263, H406, H408, H410 und H412 sind gemäß UL 60947-1 und UL 60947-4-1A als Motortrennschalter verwendbar.



Lasttrennschalter

Bauformverzeichnis

Bauform	Anwendung	ab Seite	Bauform	Anwendung	ab Seite	Bauform	Anwendung	ab Seite
003G1	Ein-/Ausschalter	80	087N4	Haupt-/Notausschalter	38	197V4	Haupt-/Notausschalter	44
003G1	Umschalter	109	087V1	Hauptschalter	72	198M1	Umschalter	130
003H1	Umschalter	109	087V4	Haupt-/Notausschalter	38	198V1	Umschalter	130
003M1	Ein-/Ausschalter	80	096M1	Ein-/Ausschalter	107	203V1	Umschalter	112
003M1	Umschalter	109	097M1	Hauptschalter	78	204M1	Umschalter	112
003V1	Umschalter	109	097M4	Haupt-/Notausschalter	44	204V1	Umschalter	112
004H1	Umschalter	109	097N1	Hauptschalter	78	206M1	Hauptschalter	51
004V1	Umschalter	109	097N4	Haupt-/Notausschalter	44	206M4	Haupt-/Notausschalter	17
013G1	Ein-/Ausschalter	80	097V1	Hauptschalter	78	206N1	Hauptschalter	51
013G1	Umschalter	109	097V4	Haupt-/Notausschalter	44	206N4	Haupt-/Notausschalter	17
013H1	Umschalter	109	126M1	Ein-/Ausschalter	86	206V1	Hauptschalter	51
013M1	Ein-/Ausschalter	80	126M1	Umschalter	113	206V4	Haupt-/Notausschalter	17
013M1	Umschalter	109	126V1	Hauptschalter	53	208M1	Ein-/Ausschalter	84
013V1	Umschalter	109	126V4	Haupt-/Notausschalter	19	209M1	Ein-/Ausschalter	84
014H1	Umschalter	109	127V1	Umschalter	113	213V1	Umschalter	112
014V1	Umschalter	109	128V1	Umschalter	113	214M1	Umschalter	112
026M1	Ein-/Ausschalter	86	136M1	Hauptschalter	46	214V1	Umschalter	112
026M1	Umschalter	113	136M4	Haupt-/Notausschalter	12	216M1	Hauptschalter	51
026N2	Ein-/Ausschalter	86	136N1	Hauptschalter	46	216M4	Haupt-/Notausschalter	17
026V1	Hauptschalter	53	136N4	Haupt-/Notausschalter	12	216N1	Hauptschalter	51
026V4	Haupt-/Notausschalter	19	176H1	Umschalter	124	216N4	Haupt-/Notausschalter	17
027V1	Umschalter	113	177H1	Hauptschalter	65	216V1	Hauptschalter	51
028V1	Umschalter	113	177H4	Haupt-/Notausschalter	31	216V4	Haupt-/Notausschalter	17
033H1	Hauptschalter	46	181M1	Ein-/Ausschalter	104	218M1	Ein-/Ausschalter	84
033H4	Haupt-/Notausschalter	12	181M1	Umschalter	127	219M1	Ein-/Ausschalter	84
033M1	Hauptschalter	46	182M1	Hauptschalter	72	234M1	Hauptschalter	56
033M4	Haupt-/Notausschalter	12	182M4	Haupt-/Notausschalter	38	234M4	Haupt-/Notausschalter	22
033N1	Hauptschalter	46	182N1	Hauptschalter	72	234N1	Hauptschalter	56
033N4	Haupt-/Notausschalter	12	182N4	Haupt-/Notausschalter	38	234N4	Haupt-/Notausschalter	22
033V1	Hauptschalter	46	183H1	Umschalter	127	234V1	Hauptschalter	56
033V4	Haupt-/Notausschalter	12	186H1	Umschalter	127	234V4	Haupt-/Notausschalter	22
034H1	Hauptschalter	63	186M1	Ein-/Ausschalter	104	238M1	Hauptschalter	56
034H4	Haupt-/Notausschalter	29	186M1	Umschalter	127	238M4	Haupt-/Notausschalter	22
034M1	Hauptschalter	63	186V1	Umschalter	127	238N1	Hauptschalter	56
034M4	Haupt-/Notausschalter	29	187H1	Hauptschalter	72	238N4	Haupt-/Notausschalter	22
034N1	Hauptschalter	63	187H4	Haupt-/Notausschalter	38	238V1	Hauptschalter	56
034N4	Haupt-/Notausschalter	29	187M1	Hauptschalter	72	238V4	Haupt-/Notausschalter	22
036M1	Hauptschalter	46	187M4	Haupt-/Notausschalter	38	242M1	Ein-/Ausschalter	89
036M4	Haupt-/Notausschalter	12	187N1	Hauptschalter	72	242M1	Umschalter	116
036N1	Hauptschalter	46	187N4	Haupt-/Notausschalter	38	242V1	Umschalter	116
036N4	Haupt-/Notausschalter	12	187V1	Hauptschalter	72	243V1	Umschalter	116
036V1	Hauptschalter	46	187V4	Haupt-/Notausschalter	38	248M1	Ein-/Ausschalter	89
036V4	Haupt-/Notausschalter	12	188M1	Umschalter	127	248M1	Umschalter	116
042G1	Ein-/Ausschalter	96	188V1	Umschalter	127	248V1	Umschalter	116
042G1	Umschalter	120	189H1	Umschalter	127	249V1	Umschalter	116
042H1	Umschalter	120	196M1	Ein-/Ausschalter	107	281M1	Hauptschalter	56
043H1	Umschalter	120	196M1	Umschalter	130	281M4	Haupt-/Notausschalter	22
077H1	Hauptschalter	65	196V1	Umschalter	130	281N1	Hauptschalter	56
077H4	Haupt-/Notausschalter	31	197M1	Hauptschalter	78	281N4	Haupt-/Notausschalter	22
086M1	Ein-/Ausschalter	104	197M4	Haupt-/Notausschalter	44	281V1	Hauptschalter	56
087M1	Hauptschalter	72	197N1	Hauptschalter	78	281V4	Haupt-/Notausschalter	22
087M4	Haupt-/Notausschalter	38	197N4	Haupt-/Notausschalter	44	283M1	Ein-/Ausschalter	89
087N1	Hauptschalter	72	197V1	Hauptschalter	78	283M1	Umschalter	116

Bauform	Anwendung	ab Seite	Bauform	Anwendung	ab Seite	Bauform	Anwendung	ab Seite
283V1	Umschalter	116	710V4	Haupt-/Notausschalter	31	976M1	Umschalter	122
285M1	Ein-/Ausschalter	91	711M1	Ein-/Ausschalter	98	977M1	Hauptschalter	67
285M1	Umschalter	116	715M1	Hauptschalter	71	977M4	Haupt-/Notausschalter	33
285V1	Umschalter	116	715M4	Haupt-/Notausschalter	37	977N1	Hauptschalter	67
286H1	Umschalter	127	715N1	Hauptschalter	71	977N4	Haupt-/Notausschalter	33
287H1	Hauptschalter	72	715N4	Haupt-/Notausschalter	37	978M1	Umschalter	122
287H4	Haupt-/Notausschalter	38	715V1	Hauptschalter	71	979H1	Umschalter	124
291V1	Umschalter	116	715V4	Haupt-/Notausschalter	37	986M1	Ein-/Ausschalter	104
293V1	Umschalter	116	716M1	Ein-/Ausschalter	103	987M1	Hauptschalter	72
449V1	Umschalter	116	720M1	Hauptschalter	67	987M4	Haupt-/Notausschalter	38
471M1	Hauptschalter	65	720M4	Haupt-/Notausschalter	33	987N1	Hauptschalter	72
471M4	Haupt-/Notausschalter	31	720N1	Hauptschalter	67	987N4	Haupt-/Notausschalter	38
471N1	Hauptschalter	65	720N4	Haupt-/Notausschalter	33	996M1	Ein-/Ausschalter	107
471N4	Haupt-/Notausschalter	31	720V1	Hauptschalter	67	997M1	Hauptschalter	78
481M1	Ein-/Ausschalter	89	720V4	Haupt-/Notausschalter	33	997M4	Haupt-/Notausschalter	44
481M1	Umschalter	116	721M1	Ein-/Ausschalter	100	997N1	Hauptschalter	78
481V1	Umschalter	116	725M1	Hauptschalter	71	997N4	Haupt-/Notausschalter	44
482M1	Ein-/Ausschalter	89	725M4	Haupt-/Notausschalter	37			
482M1	Umschalter	116	725N1	Hauptschalter	71			
482V1	Umschalter	116	725N4	Haupt-/Notausschalter	37			
483M1	Hauptschalter	56	725V1	Hauptschalter	71			
483M4	Haupt-/Notausschalter	22	725V4	Haupt-/Notausschalter	37			
483N1	Hauptschalter	56	726M1	Ein-/Ausschalter	103			
483N4	Haupt-/Notausschalter	22	727M1	Umschalter	126			
483V1	Hauptschalter	56	728V1	Umschalter	122			
483V4	Haupt-/Notausschalter	22	730M1	Hauptschalter	65			
484M1	Hauptschalter	56	730M4	Haupt-/Notausschalter	31			
484M4	Haupt-/Notausschalter	22	730N1	Hauptschalter	65			
484N1	Hauptschalter	56	730N4	Haupt-/Notausschalter	31			
484N4	Haupt-/Notausschalter	22	730V1	Hauptschalter	65			
484V1	Hauptschalter	56	730V4	Haupt-/Notausschalter	31			
484V4	Haupt-/Notausschalter	22	731M1	Ein-/Ausschalter	98			
485V1	Umschalter	116	732M1	Umschalter	122			
576H1	Umschalter	124	732V1	Umschalter	122			
576M1	Umschalter	122	733M1	Hauptschalter	67			
577M1	Hauptschalter	67	733M4	Haupt-/Notausschalter	33			
577M4	Haupt-/Notausschalter	33	733N1	Hauptschalter	67			
577N1	Hauptschalter	67	733N4	Haupt-/Notausschalter	33			
577N4	Haupt-/Notausschalter	33	733V1	Hauptschalter	67			
578M1	Ein-/Ausschalter	100	733V4	Haupt-/Notausschalter	33			
579H1	Umschalter	124	734M1	Ein-/Ausschalter	100			
700M1	Hauptschalter	65	770M1	Hauptschalter	65			
700M4	Haupt-/Notausschalter	31	770M4	Haupt-/Notausschalter	31			
700N1	Hauptschalter	65	770N1	Hauptschalter	65			
700N4	Haupt-/Notausschalter	31	770N4	Haupt-/Notausschalter	31			
700V1	Hauptschalter	65	770V1	Hauptschalter	65			
700V4	Haupt-/Notausschalter	31	770V4	Haupt-/Notausschalter	31			
701M1	Ein-/Ausschalter	98	771M1	Ein-/Ausschalter	98			
710M1	Hauptschalter	65	772M1	Umschalter	122			
710M4	Haupt-/Notausschalter	31	772V1	Umschalter	122			
710N1	Hauptschalter	65	773V1	Umschalter	122			
710N4	Haupt-/Notausschalter	31	976H1	Umschalter	124			
710V1	Hauptschalter	65	976M1	Ein-/Ausschalter	100			

Ihre Ansprechpartner in Deutschland

Sälzer Electric GmbH

Matthiasstraße 16
57482 Wenden

www.saelzer.com

Vertriebszentrum:

Tel. +49 (0) 27 62 / 6 14-110

Fax +49 (0) 27 62 / 6 14-100

sales@salzer.de

Region Berlin

KSA GmbH
Harald Schulz

Pankstraße 8–10 / Aufg. L
13127 Berlin

T (0 30) 47 48 24 00

F (0 30) 47 48 24 05

info@ksa-gmbh.de

www.ksa-gmbh.de

Regionen Bremen/Hannover/Köln

Schroeter electronic
Handelsgesellschaft mbH

Saseler Bogen 1
22393 Hamburg

T (0 40) 60 00 06-0

F (0 40) 60 00 06-30

info@schroeter-electronic-gmbh.de

www.schroeter-electronic-gmbh.de

Regionen Düsseldorf/Siegen

Christiani Elektro-Vertriebs GmbH

Innungstraße 39
50354 Hürth-Gleuel

T (0 22 33) 3 50 35

F (0 22 33) 3 61 81

vertrieb@christiani-gmbh.de

www.christiani-gmbh.de

Region Erfurt

Ingenieurbüro Steikert
Industrievertretungen

Hohle Trift 4
99706 Bendeleben

T (03 46 71) 55 79 40

F (03 46 71) 5 57 94 11

info@steikert.com

www.steikert.com

Region Frankfurt

Kurt Köberl GmbH & Co. KG
Ingenieurbüro

Rohrmühlstraße 5
63075 Offenbach

T (0 69) 75 84 67-0

F (0 69) 75 84 67-10

k.koeberl@t-online.de

www.koeberl-gmbh.de

Regionen München/Nürnberg

ETM Elektro Technisches
Management

Neuhochstadter Straße 14
82234 Weßling

T (0 81 53) 9 87 36-0

F (0 81 53) 9 87 36-29

info@etm-hv.com

www.etm-hv.com

Region Stuttgart

Schad GmbH
Ingenieurbüro

Heinkelstraße 29
73230 Kirchheim/Teck

T (0 70 21) 95 09 50

F (0 70 21) 9 50 95 40

info@schad.de

www.schad.de

Ihre Ansprechpartner weltweit

DEUTSCHLAND

Salzer Electric GmbH

Matthiasstraße 16
57482 Wenden

T +49 (0) 27 62 - 6 14-110
F +49 (0) 27 62 - 6 14-100

info@salzer.de
www.saelzer.com

GROSSBRITANNIEN

Salzer UK Ltd.

44 Edison Road
Aylesbury Bucks.
HP19 8TE

T +44 (0) 12 96 - 39 99 92
F +44 (0) 12 96 - 39 22 29

sales@salzeruk.co.uk
www.salzeruk.co.uk

U.S.A. / KANADA / MEXIKO

Salzer USA Corporation

3802 N. 54th Street
Mesa, AZ 85215

T +1 480-325-2690
F +1 480-985-9663

info@salzerusa.com
www.salzerusa.com

BELGIEN

LUXEMBURG

Bintz technics N. V.
Brixtonlaan 23
Business Park
1930 Zaventem

T +32 (0) 2 - 720 49 16
F +32 (0) 2 - 720 37 50

info@bintz.be
www.bintz.be

DÄNEMARK

Regal A/S
Industrivej 4
4000 Roskilde

T +45 - 46 77 70 00
F +45 - 46 75 76 20

regal@regal.dk
www.regal.dk

FINNLAND

UTU Oy
Valimotie 26 B (P. O. Box 252)
01531 Vantaa

T +358 - 9 - 2746 411
F +358 - 9 - 2746 4141

www.utu.eu

ITALIEN

Telestar S. r. l.
Via Novara, 35
28010 Vaprio d'Agogna (NO)

T +39 (0) 0331 966 768
F +39 (0) 0321 996 281

telestar@telestar-automation.it
www.telestar-automation.it

NIEDERLANDE

Solar Nederland B.V.
Toermalijnstraat 7
1812 RL Alkmaar

T +31 (0) 88 - 765 2700

info@solarnederland.nl
www.solarnederland.nl

NORWEGEN

EFA ELEKTRO A. S.
Postboks 593
1411 Kolbotn

T +47 - 6681 2400

post@efa.no
www.efa.no

ÖSTERREICH

Schmachtl GmbH
Pummererstraße 36
4020 Linz

T +43 (0) 7 32 - 76 46-0
F +43 (0) 7 32 - 78 50 36

office.linz@schmachtl.at
www.schmachtl.at

SINGAPUR

Electrimec Asia Pacific Pte Ltd
17 Tuas Street (Off Pioneer Road)
Singapore 638454

T +65 - 6896 2979
F +65 - 6896 2925

elecmecc@singnet.com.sg

SPANIEN

Euromatel S. L.
Avenida Real de Pinto, 87
Nave II-A
28021 Madrid

T +34 - 91 - 3 58 92 70
F +34 - 91 - 3 58 92 95

info@euromatel.es
www.euromatel.es

SÜDAFRIKA

Waco Industries
11, Cleveland Road
Cleveland – Johannesburg

T +27 (0) 11 - 677 2500
F +27 (0) 11 - 677 2608

wacobuy@voltex.co.za
www.wacoelec.co.za

SCHWEIZ

EHS Switzerland AG
Richensee 1
6285 Hitzkirch

T +41 (0) 41 440 84 46
F +41 (0) 41 440 84 42

info@ehs.ch
www.ehs.ch

TSCHECHIEN

SLOWAKEI

WAPRO spol. s r.o.
Rumunská 27
79601 Prostějov

T +420 582 334 676
F +420 582 334 677

info@wapro.cz
www.wapro.cz



Sälzer Electric GmbH
Matthiasstraße 16
57482 Wenden
www.saelzer.com

Vertriebszentrum:
Tel. +49 (0) 27 62 / 6 14-110
Fax +49 (0) 27 62 / 6 14-100
sales@salzer.de